

California AHMCT Program  
University of California at Davis  
California Department of Transportation

**ADVANCED SNOWPLOW DEVELOPMENT  
AND DEMONSTRATION:  
PHASE I: DRIVER ASSISTANCE\***

Kin S. Yen<sup>1</sup>, Han-Shue Tan<sup>2</sup>, Aaron Steinfeld<sup>2</sup>, Colin H. Thorne<sup>1</sup>,  
Bénédicte Bougler<sup>2</sup>, Eli Cuelho<sup>3</sup>, Paul Kretz<sup>2</sup>, Dan Empey<sup>2</sup>,  
Ronald R. Kappesser<sup>1</sup>, Hassan Abou Ghaida<sup>1</sup>, Mike Jenkinson<sup>4</sup>,  
Stephen R. Owen<sup>5</sup>, Wei-Bin Zhang<sup>2</sup>, Ty A. Lasky<sup>1</sup>, and

Bahram Ravani<sup>1</sup>, Principal Investigator

AHMCT Research Report  
UCD-ARR-99-06-30-03

Final Report of Contract  
Task Order 96-9 under IA65X875

June 30, 1999

**Affiliations:**

1. AHMCT Research Center, Department of Mechanical & Aeronautical Engineering, University of California, Davis, CA 95616-5294
2. California PATH, University of California, Berkeley, 1357 So. 46th St., Richmond, CA 94804-4603
3. Western Transportation Institute, PO Box 173910, Montana State University, Bozeman, MT 59717-3910
4. Caltrans New Technology & Research Program, P.O. Box 942873, MS 83, Sacramento, CA, 94273-0001
5. Arizona DOT, Arizona Transportation Research Center, 1130 N. 22nd Avenue, Phoenix, AZ 85009

\* This report has been prepared in cooperation with the State of California, Business and Transportation Agency, Department of Transportation and is based on work supported by Contract Number IA 65X875 T.O. 96-9 through the Advanced Highway Maintenance and Construction Technology Research Center at the University of California at Davis.



## ABSTRACT

This final report documents application of Intelligent Vehicle (IV) and Advanced Vehicle Control and Safety Systems (AVCSS) technologies to enhance the safety and efficiency of snow removal. The system developed, known as the Advanced Snowplow (ASP), includes lane position indication and lane departure warning, as well as a forward collision warning system. The technology has been integrated onto a Caltrans 10-wheel 10-yard plow, and tested through the Winter of 1998 – 1999 in the California Advanced Winter Maintenance Testbed on Interstate 80 near Donner Summit. The system was also tested for two weeks at a similar site on US 180 near Flagstaff, Arizona. The report provides an introduction to the problem, and overview of the system hardware and software, a detailed discussion of the human-machine interface, the magnetic sensing system, and the collision warning system, preliminary evaluation and findings, and conclusions and recommendations for future research.



## EXECUTIVE SUMMARY

Clearing busy highways during the winter months can sometimes be treacherous. Since the economy in the Sierras and other areas depends so much upon tourism and supply couriers, the main highways must stay open during the winter even during stormy conditions. Under the extreme conditions of snow storms, the snowplow drivers must use every instinct to keep safely moving along the highway. The mountainous terrain common in the snowy areas of California and Northern Arizona provides quite a challenge to the snowplow driver with a limited view of the road. Snow-covered vehicles parked on the shoulder offer additional challenge to the snowplow operator. The AHMCT Research Center, in conjunction with its research partners, has developed a system that provides assistance to the snowplow operator in locating the road and obstacles under the snow.

The Advanced Snowplow (ASP) project developed and tested a driver information system in the Winter of 1998/99. A display designed for maximum comfortable driver assistance shows where the plow is relative to the roadway and also alerts the driver if obstacles are detected within the path of the plow. The system is designed to operate in the snowy, icy, and otherwise harsh conditions typical in the snowplow environment. For the 1998/1999 Winter testing, information-only driver assistance (i.e. advisory information) was tested. Future work could include automation to guide the snow removal vehicle down the snow-covered highway and avoid collisions by stopping, slowing, or moving around a detected snow-covered obstacle.

Technical development for the ASP involves a partnership between the AHMCT Research Center and UC Berkeley's Partners for Advanced Transit and Highways (PATH) Center. A third partner, the Western Transportation Institute of Montana State University, evaluated the performance improvements the system provides.

Magnets were installed in a test section on Highway 80's well-traveled Donner Summit in California. A similar test site was established on US 180, a more rural location north of Flagstaff Arizona. Additional test sections will be installed in California, Arizona and other states. PATH researchers provided expertise in the area of magnetometers and vehicle positioning technologies used for the vehicle guidance.

Radar is used for the detection of obstacles in the path of the snowplow vehicle. Future research will include radar detection for the wingplow, which projects into the adjacent lane. With the careful consideration of the harsh and complicated snowplow environment, UC Davis' AHMCT researchers have installed a radar unit designed to provide both the sensitivity needed for accurate obstacle detection and also the ruggedness needed for durable reliability. Being the leader in this project, the AHMCT researchers also provided the vehicle integration and installation expertise for the multiple technologies on this plow.

The system was successfully tested through the Winter of 1998-1999. Operators at California's Donner Pass test site used the system regularly from December 1998 until the end of the snow season. In addition, the system was tested for approximately two weeks at the Arizona test site. Operator feedback has been quite positive; where improvements were suggested, revisions have been made, or will be addressed in Phase II research, beginning July 1999.



## TABLE OF CONTENTS

<i>Abstract</i> .....	<i>iii</i>
<i>Executive Summary</i> .....	<i>v</i>
<i>Table of Contents</i> .....	<i>vii</i>
<i>List of Figures</i> .....	<i>xi</i>
<i>List of Tables</i> .....	<i>xiii</i>
<i>Disclaimer/Disclosure</i> .....	<i>xv</i>
<i>List of Acronyms and Abbreviations</i> .....	<i>xvii</i>
<i>Acknowledgments</i> .....	<i>xix</i>
<i>Chapter One</i> .....	<i>1</i>
<i>Introduction</i> .....	<i>1</i>
<i>Motivation</i> .....	<i>1</i>
<i>Project Overview</i> .....	<i>2</i>
<i>System Cost</i> .....	<i>3</i>
<i>Test Site Infrastructure</i> .....	<i>3</i>
<i>Report Overview</i> .....	<i>4</i>
<i>Chapter Two</i> .....	<i>7</i>
<i>System Overview</i> .....	<i>7</i>
<i>Lateral Sensing</i> .....	<i>7</i>
<i>Collision Warning System</i> .....	<i>9</i>
<i>Human-Machine Interface</i> .....	<i>10</i>
<i>Current System Status</i> .....	<i>11</i>
<i>Chapter Three</i> .....	<i>13</i>
<i>ASP System Hardware</i> .....	<i>13</i>
<i>Chapter Four</i> .....	<i>21</i>
<i>Software Architecture</i> .....	<i>21</i>
<i>Magnetic Sensing System Process</i> .....	<i>22</i>
<i>Database Process</i> .....	<i>23</i>
<i>Radar Process</i> .....	<i>25</i>
<i>Encoder Process</i> .....	<i>26</i>
<i>Display Process</i> .....	<i>27</i>

<b>Chapter Five</b> .....	<b>31</b>
<b>Human-Machine Interface</b> .....	<b>31</b>
<b>Introduction</b> .....	<b>31</b>
<b>Prototype Development</b> .....	<b>32</b>
<b>Operational System</b> .....	<b>41</b>
<b>HMI Conclusions</b> .....	<b>49</b>
<b>Chapter Six</b> .....	<b>51</b>
<b>Magnetic Sensing System</b> .....	<b>51</b>
<b>Introduction</b> .....	<b>51</b>
<b>Magnetic Marker Model</b> .....	<b>51</b>
<b>Noise Effects</b> .....	<b>52</b>
<b>Magnetic Sensing Algorithm</b> .....	<b>53</b>
<b>Signal Processing Algorithm</b> .....	<b>55</b>
<b>Chapter Seven</b> .....	<b>57</b>
<b>Collision Warning System</b> .....	<b>57</b>
<b>Sensing Requirements</b> .....	<b>57</b>
<b>Sensing Technologies</b> .....	<b>57</b>
<b>System Selection</b> .....	<b>58</b>
<b>Capabilities</b> .....	<b>59</b>
<b>False Warning Suppression</b> .....	<b>59</b>
<b>Vehicle and Computer Interface</b> .....	<b>60</b>
<b>Suggested Future Capabilities</b> .....	<b>60</b>
<b>Chapter Eight</b> .....	<b>63</b>
<b>Test Results and Evaluation</b> .....	<b>63</b>
<b>Introduction</b> .....	<b>63</b>
<b>Evaluation Methodology</b> .....	<b>65</b>
<b>Data Collection</b> .....	<b>68</b>
<b>Evaluation Conclusion</b> .....	<b>82</b>
<b>Chapter Nine</b> .....	<b>87</b>
<b>Conclusions and Future Research</b> .....	<b>87</b>
<b>Conclusions</b> .....	<b>87</b>
<b>Future Research and Development</b> .....	<b>87</b>
<b>References</b> .....	<b>91</b>



<b><i>Appendix A</i></b> .....	<b>93</b>
<b><i>Interview Program</i></b> .....	<b>93</b>
<b><i>Appendix B</i></b> .....	<b>95</b>
<b><i>Arizona Survey Advanced Snowplow Evaluation Questionnaire</i></b> .....	<b>95</b>
<b>Arizona Demo</b> .....	<b>95</b>
<b><i>Appendix C</i></b> .....	<b>97</b>
<b><i>Arizona Magnet Installation Tests</i></b> .....	<b>97</b>
<b>General Results</b> .....	<b>98</b>
<b>Results By Site</b> .....	<b>98</b>
<b>Conclusions &amp; Recommendations</b> .....	<b>98</b>
<b>Acknowledgements</b> .....	<b>99</b>



## LIST OF FIGURES

Figure 1-1: The Advanced Snowplow (ASP) in Operation on Interstate 80, near Donner Summit, in California .....	2
Figure 2-1: System Call-Out for the Advanced Snowplow, with Key Subsystems.....	7
Figure 3-1: Equipment Location Layout Schematic.....	13
Figure 3-2: Industrial Computer Chassis Used.....	14
Figure 3-3: System Power and Reset Switches.....	14
Figure 3-4: System Layout, Including LCD Panel for HMI.....	15
Figure 3-5: Hardware Mount for the LCD Panel .....	15
Figure 3-6: Absolute Encoder for Steering Wheel Angle Sensing .....	16
Figure 3-7: Center Portion of Front Magnetometer Sensor Array .....	17
Figure 3-8: Rear Magnetometer Sensor Array .....	17
Figure 3-8: Custom Sensor I/O Board, Top View.....	18
Figure 3-9: Side View of Sensor I/O Boards.....	18
Figure 3-10: ASP Power Supply System .....	19
Figure 4-1: System Diagram .....	21
Figure 4-2: Magnetic Sensing Software Process Diagram.....	23
Figure 4-3: Database Process Diagram.....	24
Figure 4-4: Radar Process Diagram.....	26
Figure 4-5: Encoder Process Diagram .....	27
Figure 4-6: Screen shot of the in-vehicle display.....	28
Figure 4-7: Display Process Diagram.....	29
Figure 5-1: A Typical View from the Cab of a Snowplow at Donner Pass. A Forward Plow Is Seen at the Left Shoulder, the Lead Plow Is Barely Visible.....	32
Figure 5-2: PATH Richmond Field Station Track.....	33
Figure 5-3: Lateral Performance of Subject 0, 0 and 15 Meter Look-Ahead Distances.....	34
Figure 5-4: A Text-Based Representation of the Road.....	34
Figure 5-5: Experimenter Driving from the Character Display with a Simulated Whiteout .....	35
Figure 5-6: Lateral Performance of Subject 2.....	36
Figure 5-7: Speed Performance of Subject 2 .....	36
Figure 5-8: Mean Driver Speed as a Function of Curve Radius and Display Type, with 95% Confidence Intervals .....	37
Figure 5-9: Mean Forward Lateral Displacement Magnitude as a Function of Curve Radius and Display Type, with 95% Confidence Intervals .....	37
Figure 5-10: Standard Deviation Data for Second Mini-Study .....	38
Figure 5-11: Mean Lateral Displacement from Lane Centerline, 122 Meter Radius Removed, with 95% Confidence Intervals .....	38
Figure 5-12: The Impact of Practice, with 95% Confidence Intervals.....	39
Figure 5-13: Speed Behavior for Long-Break Practice, with 95% Confidence Intervals.....	40
Figure 5-14: Speed Behavior for Short-Break Practice, with 95% Confidence Intervals.....	40
Figure 5-15: A Drawing of a Display Scenario.....	41
Figure 5-16: Location of the Display in the Cab .....	42
Figure 5-17: Overall Ratings as a Function of Experience and Exposure, Ratings Are 1 - 5, Higher Being Better .....	45
Figure 5-18: Predicted Time to Reach Comfort with the System.....	46
Figure 5-19: Driver Behavior Data during System Testing in Arizona, with 95% Confidence Intervals.....	47
Figure 5-20: Mean Speed as a Function of Curve Radius .....	47
Figure 5-21: Mean FLD as a Function of Curve Radius .....	48
Figure 5-22: Steering Angle Standard Deviation as a Function of Curve Radius.....	48
Figure 5-23: Standard Deviation Data .....	49
Figure 6-1: Snowplow Front-Center Magnetic Table.....	55
Figure 6-2: “Peak-Mapping” Magnetometer Signal Processing Block Diagram.....	56
Figure 7-1: Plow Stopping Distance for 0.1 g Deceleration and 1.0 Second Reaction Time.....	58
Figure 7-2: Diagram of Area Covered by EVT-200 Collision Warning System .....	59

<b>Figure 7-3: Diagram of Situation Capable of Generating a False Collision Warning .....</b>	<b>60</b>
<b>Figure 7-4: Collision Caused by a Drifting Vehicle, a.k.a. “Clipping” .....</b>	<b>61</b>
<b>Figure 8-1: Demonstration Site over Donner Pass, California.....</b>	<b>63</b>
<b>Figure 8-2: Demonstration Site through Kendrick Park, Arizona .....</b>	<b>64</b>
<b>Figure 8-3: Accident Distribution by Month over Donner Pass, California from October 1, 1995 to September 30, 1998 .....</b>	<b>69</b>
<b>Figure 8-4: Percent and Number of Accidents for Various Road Surface Conditions over Donner Pass, California from October 1, 1995 to September 30, 1998.....</b>	<b>70</b>
<b>Figure 8-5: Percent and Number of Accidents for Various Road Surface Conditions around Kendrick Park, Arizona for the Winters between October 1, 1994 and May 1, 1999.....</b>	<b>70</b>
<b>Figure 8-6: Frequency of Road Closures on both Directions of Interstate 80 in California for 1974 - 1999 ....</b>	<b>71</b>
<b>Figure 8-7: Total Snowfall near Donner Pass, California for 1974 - 1999 .....</b>	<b>72</b>
<b>Figure 8-8: Total Snowfall near Arizona Test Site for 1909 - 1996.....</b>	<b>73</b>
<b>Figure 8-9: Days Chains Required over Donner Pass, California for 1974-1999.....</b>	<b>73</b>
<b>Figure 8-10: Sample Ride-Along Data Collection Sheet for the California Site.....</b>	<b>74</b>
<b>Figure 8-11: Run Times for Ride-Alongs over Donner Pass, California.....</b>	<b>75</b>

## LIST OF TABLES

<b>Table 5-1: Display Sequence for Each Subject.....</b>	<b>35</b>
<b>Table 5-2: Survey Results.....</b>	<b>45</b>
<b>Table 8-2: Total Reported Accidents and Associated Maintenance Costs to Maintenance Equipment out of the Kingvale Maintenance Shop in California .....</b>	<b>76</b>
<b>Table 8-3: Summary of Snowplow Operator Responses based on Results from Interviews.....</b>	<b>80</b>



## DISCLAIMER/DISCLOSURE

The research reported herein was performed as part of the Advanced Highway Maintenance and Construction Technology Program (AHMCT), within the Department of Mechanical and Aeronautical Engineering at the University of California, Davis and the New Technology and Research Program at the California Department of Transportation. It is evolutionary and voluntary. It is a cooperative venture of local, state and federal governments and universities.

The contents of this report reflect the views of the author(s) who is (are) responsible for the facts and the accuracy of the data presented herein. The contents do not necessarily reflect the official views or policies of the State of California, the Federal Highway Administration, or the University of California. This report does not constitute a standard, specification, or regulation.





## LIST OF ACRONYMS AND ABBREVIATIONS

<b>Acronym</b>	<b>Definition</b>
ACMS	Advanced Construction and Maintenance Systems
ADOT	Arizona Department of Transportation
AHMCT	Advanced Highway Maintenance and Construction Technology
APS	Applied Physics Systems
ASP	Advanced Snowplow
ASP-II	Advanced Snowplow, Phase II
ATRC	Arizona Transportation Research Center
AVCSS	Advanced Vehicle Control and Safety Systems
AWMT	Advanced Winter Maintenance Testbed
Caltrans	California State Department of Transportation
CWS	Collision Warning System
DGPS	Differential Global Positioning System
DOT	Department of Transportation
EMI	Electromagnetic Interference
FLD	Front Lateral Displacement
GPS	Global Positioning System
HMI	Human-Machine Interface
HUD	Head-Up Display
ISTEA	Intermodal Surface Transportation Efficiency Act of 1991
I-80	Interstate 80
ITS	Intelligent Transportation Systems
ITSA	Intelligent Transportation Society of America
IV	Intelligent Vehicle
IVI	Intelligent Vehicle Initiative
LCD	Liquid Crystal Display
LIDAR	Light Detecting and Ranging
MMW	Millimeter Wave
MOE	Measure of Effectiveness
MP	Milepost
MSU	Montana State University
NAHSC	National Automated Highway Systems Consortium
PATH	Partners for Advanced Transit and Highways
RF	Radio Frequency
RFI	Radio Frequency Interference
RPM	Raised Pavement Marker
RTOS	Real-Time Operating System
SBC	Single Board Computer
UCB	University of California at Berkeley
UCD	University of California-Davis
WTI	Western Transportation Institute



## ACKNOWLEDGMENTS

The authors thank the California State Department of Transportation for their support. In addition, the authors thank the Arizona State Department of Transportation and its staff for their participation and cooperation in this research effort. The authors would also like to acknowledge the dedicated efforts of the AHMCT ASP development team, as well as those of AHMCT's research partners at Caltrans, ADOT, PATH, and WTI, without whom this work would not have been possible. Finally, the authors would like to thank the Sierra Snowfighters at the Kingvale Maintenance Center for their insight, interest, and hospitality.



## CHAPTER ONE

### INTRODUCTION

This report documents the Advanced Highway Maintenance and Construction Technology (AHMCT) Center's development of the Advanced Snowplow (ASP). The document provides motivation, system overview, major subsystems, and functions. It also describes Human-Machine Interface (HMI), the magnetic sensing system, and the radar-based Collision Warning System (CWS) in detail. Finally, it provides details of the first year's field-testing and evaluation, along with conclusions and recommendations for future research.

#### Motivation

Winter maintenance operations, including snow removal, are subject to increased risk. Snowplows must operate in the worst of conditions, including completely covered roads, very low traction, and complete visual whiteout. In addition, in California and other states, the consequences of road run-off are more severe due to the mountainous terrain in which much of the snow removal operations must be performed. Additional danger comes from hidden objects covered in snow, and improper visual cues resulting from previous plowing. The operating environment and the nature of the risks indicates a significant opportunity to enhance the safety of the maintenance operator and the traveling public through the appropriate application of near-term Advanced Vehicle Control and Safety Systems (AVCSS) and Intelligent Vehicle (IV) technologies. The Advanced Highway Maintenance and Construction Technology (AHMCT) Center at the University of California - Davis (UCD) has developed driver assistance, in the form of lane position indication and forward and side collision warning to increase the safety of the snowplow operation. AHMCT performed this work in conjunction with its partners, the California Partners for Advanced Transit and Highways (PATH) of the University of California at Berkeley (UCB), and the Western Transportation Institute (WTI) of Montana State University (MSU). The efforts of this research team have allowed deployment of the Advanced Snowplow (ASP) Driver Assistance System into Caltrans' maintenance fleet in just over half a year's time [10].

Researchers at the AHMCT Center, as well as our research partners at the California State Department of Transportation (Caltrans), have long considered the benefits of providing guidance information and/or control to enhance winter maintenance activities. The ASP Driver Assistance System clearly demonstrates the near-term benefits of AVCSS technologies in general, and for winter maintenance in particular. The main goal of this project is to assist the snowplow operator in safely and efficiently performing snow removal. A subsidiary goal is the demonstration of the beneficial near-term application of AVCSS and IV technologies for maintenance operations. The ASP Driver Assistance System developed in this research has been field-tested in Caltrans' Advanced Winter Maintenance Testbed (AWMT) on Interstate 80 near Donner Summit. It was also tested for approximately two weeks at a test site on US 180 in Kendrick Park, near Flagstaff, Arizona.

### Project Overview

The ASP system functions include lane position indication, lane departure warning, and forward collision warning. Lane position indication and lane departure warning were developed by PATH using their embedded magnetic reference marker system for lateral position indication within the lane. Feasibility of this technology was shown at the National Automated Highway Systems Consortium (NAHSC) 1997 Demonstration; the technology is considered robust and well-suited for the current application. The Collision Warning System (CWS) was developed by AHMCT, using a millimeter wave radar system, which performs well in the snow environment; this system is intended to detect vehicles and other inorganic objects buried or obscured by snow. The current CWS on the ASP is based on the Commercial-Off-The-Shelf (COTS) Eaton Vorad EVT-200 sensor, which provides range and rate to targets, and supports serial communication via the RS-232 standard. AHMCT and PATH jointly developed the Human-Machine Interface (HMI). AHMCT integrated all subsystems on the snowplow. The overall system architecture used on the ASP is based on an open architecture, so that other sensors and subsystems can be incorporated in the future. Caltrans provided the snowplow. The vehicle, deployed into operation in December 1998, can be seen in Figure 1-1.



**Figure 1-1: The Advanced Snowplow (ASP) in Operation on Interstate 80, near Donner Summit, in California**

During the summer of 1998, Caltrans developed a test corridor for field-testing and demonstration of the ASP. This Advanced Winter Maintenance Testbed (AWMT), located on Interstate 80 near Donner Summit, currently has about four miles of lane two (three-lane road) instrumented with the discrete magnetic marker system. Further infrastructure installations are

being considered for this corridor, as well as extensions further west along Interstate 80, to allow longer test runs, as well as testing of other advanced winter maintenance vehicles currently being considered. During the same timeframe, Arizona developed a four-mile test site on US 180 in Kendrick Park, near Flagstaff Arizona.

Caltrans snowplow operators tested the system in storm conditions starting early in December 1998. Feedback from the operators is very positive. The Caltrans operators were involved with the design of the system, particularly the HMI, from early in the project. Arizona operators also tested the system for about two weeks in March 1999, and also provided very helpful feedback. CA and AZ DOT operators and managers continue to provide valuable feedback, and the research team continues to improve the system based on these suggestions. The rapid deployment of this system into operation in a maintenance fleet represents an early success in the application of Intelligent Vehicle and AVCSS technologies for Special Vehicles.

### System Cost

The cost for equipment and labor to develop the ASP prototype vehicle is estimated at approximately \$75,000. Based on foreseen revisions in hardware and installation approaches, the current estimate for a production unit is at or below \$20,000. Cost of infrastructure installation for the test sites was approximately \$25,000 per mile, including surveying, installation, and magnets. The cost is evenly divided between surveying and mechanical installation of the magnets. These costs are expected to drop based on refinements in the installation procedure. In particular, under a separate project, the AHMCT Center is currently developing prototype machinery to automate the mechanical installation process of reference markers, as well as a major portion of the surveying process. With such automation, it is reasonable to assume that the installation cost will be reduced by at least 50%.

### Test Site Infrastructure

The ASP was field-tested in Caltrans' Advanced Winter Maintenance Testbed (AWMT) on Interstate 80 near Donner Summit over the winter of 1998-1999. It was also tested for approximately two weeks at Arizona's test site on US 180 in Kendrick Park, near Flagstaff, Arizona. Magnets were installed at both sites in the summer of 1998. Additional test sections are anticipated in California, Arizona, and other states.

During the summer of 1998, Caltrans developed a test corridor for field-testing and demonstration of the ASP. This Advanced Winter Maintenance Testbed (AWMT), located on Interstate 80 in Nevada County near Donner Summit, currently has approximately 6.3 km (3.9 miles) of lane two (three-lane road) instrumented with the discrete magnetic marker system. The test track is at a high elevation (1,950 – 2,190 m, or 6,400 – 7,200 ft) and records large snow accumulations (as much as 16.5 m (54 ft) of snowfall a season with roadside accumulations reaching 6 m (20 ft) high). Whiteouts are common due to blowing wind and the sheer volume of snow. The stretch of road instrumented with magnets is a divided, restricted-access highway with three lanes and wide shoulders traveling uphill and west between the Donner Lake (milepost (MP) Nev-9.1) and Castle Peak (MP Nev-5.1) interchanges. The test route starts about halfway up the northern slope of the Donner Lake valley and ends at the pass summit on the west end of the valley. The entire site is located in mountainous terrain, with steep grades and many

curves. The location was selected because this portion of I-80 typically closes before other sections of the road due to weather patterns and has a relatively high vehicle per hour traffic count. Further infrastructure installations are expected for this corridor, timed with scheduled roadway maintenance, as well as extensions further west along Interstate 80.

Arizona's test site, located on a stretch of US 180, consists of a two-lane undivided rural mountain road with frequent whiteouts due to high winds. This installation is along a rural, two-lane highway, with areas of relatively high curvature and very high winds. The site currently represents a total of approximately 6.4 km (4 miles) within Kendrick Park, located about 32 km (20 miles) northwest of Flagstaff, Arizona. This instrumented test-site is situated at roughly 2440 m (8000 ft) in elevation and runs northward from MP 235.0 to MP 238.0 and southward from MP 238.0 to MP 237.0. The northbound 4.6 km (3.0 mile) segment begins in forest, continues through an open, windswept valley and ends with a winding eight percent downgrade. The southbound 1.6 km (1.0 mile) segment returns back through the winding uphill grade. This location receives frequent snowfall and is often exposed to winds of varying force, resulting in whiteout conditions and drifting. The designated road segment is in a relatively high traffic area because it is the shortest route from Flagstaff to Grand Canyon National Park. Arizona will extend their test site by about 3.2 km (2.0 miles) in September 1999, thus completing a 9.2 km (6.0 mile) closed loop. Arizona also performed valuable magnet installation tests, as documented in Appendix C.

### Report Overview

The remainder of the report provides details of the ASP system, subsystems, and testing. Particular emphasis and detail is provided for the HMI and for the evaluation of the system, as these issues address the aspects of the ASP that are most relevant to the end user.

Chapter 2 provides a more detailed overview of the entire ASP system architecture, as well as preliminary details on the main subsystems, namely, the lateral positioning system, the collision warning system, and the human-machine interface.

Chapter 3 provides detailed information and photos of the hardware installation on the ASP. This includes the sensing systems for both lateral positioning and for obstacle detection. It also includes the in-cab display and controls. Finally, it includes the computing, power electronics, and miscellaneous support subsystems for the vehicle.

Chapter 4 documents the software architecture used in the ASP. The architecture is based on a set of independent processes that communicate through a shared database process. The system is based on the QNX Real-Time Operating System (RTOS).

Chapter 5 provides a detailed discussion of the human-machine interface (HMI). This is the most critical aspect of the ASP, as it is the one means of presenting the driver assistance information to the operator. The chapter discusses the requirements of the operation and the goals for the interface, mini-studies used to develop the display imagery (including detailed testing results), and the display imagery itself. Some discussion of operator impressions is also provided, along with results from the first winter's testing, including data collected.



Chapter 6 discusses the magnetic sensing system. This system provides the lateral position information needed to show the operator the current vehicle position. In addition, as the system allows coding of roadway curvature, with the combination of a steering wheel encoder, the magnetic sensing can also provide critical predictor information to the operator, i.e. it provides a representation of both current and future vehicle location. The chapter provides an overview of the magnetic marker model, noise effects, and the sensing and signal processing algorithms used.

Chapter 7 discusses the radar system used in the Collision Warning System. This chapter provides a review of the sensing requirements, along with an overview of the COTS hardware used, i.e. the EVT-200 radar system. False warning suppression issues and techniques are also discussed, along with some detail on the interface between the ASP computer and the EVT-200 sensor. Finally, the chapter presents challenges encountered in the current development, and envisioned hardware and algorithmic changes to address these challenges in future phase research.

Chapter 8 provides the details of the system evaluation and testing. This chapter provides further detail on the nature of the problems to be addressed by the ASP, including details of traffic, accident, and weather data for the test corridors selected. It also discusses detailed aspects of the two test sites, along with the evaluation methodology used, including Measures of Effectiveness (MOEs), test setup and data collection. In addition, it provides operator feedback obtained from forms, surveys, and interviews. Finally, it provides numerous challenges and recommendations for future system improvements, and thus represents a very valuable reference for future research.

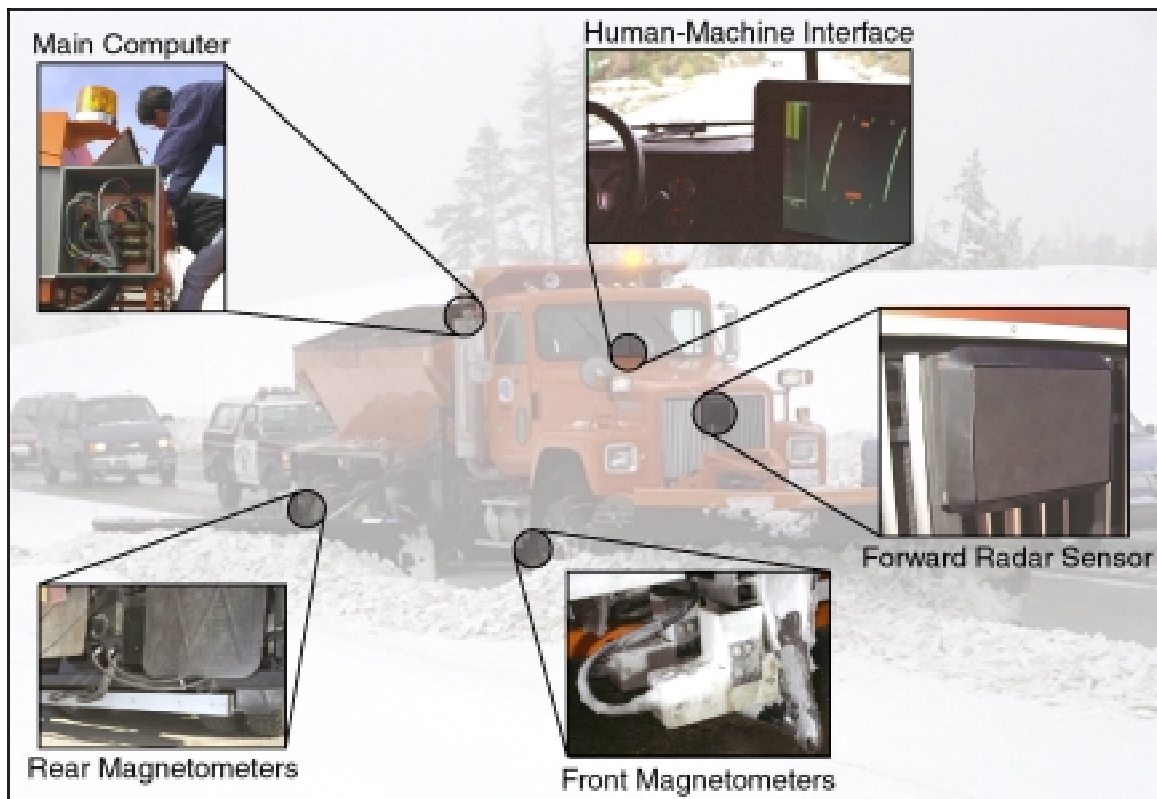
Chapter 9 provides conclusions, lessons learned, and recommendations for future work. Appendix material provides the interview program used to guide the researcher when discussing the system with operators, the evaluation questionnaire used in the Arizona testing, and the results of magnet installation testing performed by ADOT.



## CHAPTER TWO

### SYSTEM OVERVIEW

The ASP system technology has been integrated onto a Caltrans nose/wing plow vehicle, based on an International Paystar 5000 platform. This chapter provides a brief description of the main subsystems of the ASP: the Lateral Sensing System, the Collision Warning System, and the Human-Machine Interface, all shown in Figure 2-1. Other support subsystems, e.g. computing and power, are discussed in detail in Chapter 3. The software architecture used to implement all ASP functions is discussed in Chapter 4.



**Figure 2-1: System Call-Out for the Advanced Snowplow, with Key Subsystems**

#### Lateral Sensing

Snowplow operating conditions such as poor road delineation, obscured pavement, reduced visibility due to rain and snowstorm, low temperature, and mountainous roads are a significant factor in the choice of technologies for lateral sensing. There are several well-developed technologies for vehicle lateral guidance for AHS. They may be classified as vision-based, roadway reference system based, and radio wave signal based methods. Vision-based systems are generally considered inappropriate in poor visibility conditions such as fog, rain, and particularly snow. GPS-based sensing is one form of radio method; it is unknown whether a GPS-based approach is reliable in the environments considered in this study. The research team

selected a roadway reference based approach, rather than autonomous sensing, such as a vision system, in order to provide the required sensing reliability and robustness [22].

Roadway reference systems include induction wires, radar-reflective tape, magnetic tape [8], and discrete reference markers. Reference system elements may be passive or active. Example markers include magnets, colored paint marks, retroreflective raised pavement markers, and radar-reflective materials. Any optic-based marker detection system faces the same problem as any other vision-based system in a snow removal environment; as such, these systems are not feasible here. In addition, marker technologies that are at the pavement level or higher are subject to removal by the plowing operation. . At Donner Summit, the painted lane markings are usually completely scraped off by the end of the winter season, often much more quickly. PATH experiments using embedded magnetic markers for lateral control have shown a maximum lateral sensing error of 1.5 cm with 1 cm standard deviation [11]. This is well within the 3 cm requirement. Discrete magnetic markers embedded in the roadway can be used for longitudinal position measurement as well as lateral control. Moreover, magnetic markers can be coded with other roadway information by flipping polarities, which each vehicle can read via onboard magnetometers. Magnetic pavement marker tape has been shown to have similar performance [8] for lateral position measurement; however, it cannot be coded to provide roadway information, and the material appears to be quite expensive relative to magnets. Based on the maturity and robustness of the magnetic marker technology, it was selected for use in the current study.

Magnets were installed along a four-mile stretch of Interstate 80 (I-80) near Donner Summit, in California. Currently, the magnets are installed in the center of lane two of this three-lane stretch of divided road. This provides the sensing needed to guide the lead plow of a snowplow platoon or echelon formation during whiteout conditions, and in cases where the roadway is completely obscured by ground snow. Once the lead plow has made its pass along the roadway, the remaining plows can use its windrow (snowdrift) as a visual guide. Arizona installed an additional test site on US 180 in Kendrick Park, north of Flagstaff, Arizona. This installation is along a rural, two-lane highway, with areas of relatively high curvature, and very high winds. Further details of the test sites can be found in Chapter 8.

The ASP is instrumented with two arrays (front and rear) of seven magnetometers each. Three magnetometers on front and rear are sufficient for an automatically steered vehicle, while five are deemed necessary with manual driving to allow for human error. In addition, operators often drive with an offset from lane center on the order of 0.6 m (2 ft), which leads to a need for an extra magnetometer on either end of the array, providing a total range of approximately  $\pm 1$  m. At any given time, three magnetometers are considered active, and an algorithm decides when to shift the active magnetometers based on field strength. PATH has modified its existing sensing algorithms used for automatic vehicle control to meet the specific needs of the ASP. The sensing system provides lateral measurement as well as an estimate of the vehicle's heading with respect to the road. In addition, the system extracts milepost and curvature information from the binary coding in the magnets. With this combination of information, along with vehicle steering angle obtained from a steering wheel encoder, the system can display current as well as predicted vehicle location with respect to the road, as well as the upcoming curvature. The HMI to display this information is discussed below, and in great detail in Chapter 5. Further detail regarding the lateral sensing can be found in Chapter 6, as well as [23]. Note that tests at the end of the project

indicate that, at typical plowing speeds, it is sufficient to instrument only the front of the plow, so that the number of sensors required is cut in half. The research team is investigating this issue as part of Phase II research, herein referred to as ASP-II. Clearly, this will have positive implications in terms of increased robustness, as well as reduced system cost, complexity, and installation.

### Collision Warning System

The adverse operating conditions expected in normal operation, including falling snow, snow coverage, and rain, impact the choice of sensing system for the Collision Warning System (CWS) on the ASP. Additional complications arise for obstacle detection due to road curvature in mountainous areas. Snowplows operating in the mountainous roads of California and Arizona, for example, face roads with high curvature, which complicate obstacle detection methods.

There are many sensing methods capable of detecting roadway obstacles. The principle technologies used in current highway automation research include vision, ultrasonic, LIDAR / LASER radar, and millimeter wave (MMW) radar. Several of these technologies can be discounted immediately for the snow environment. Vision-based systems, as well as LIDAR systems, depend on lighting and optical field-of-view, both of which are severely impeded during inclement weather conditions. Ultrasonic sensors are also inadequate in adverse weather conditions. Accuracy of distance measurement is affected not only by wind gusts, but also by rain and snow. Because the speed of sound differs in air, snow, and water, presence of snow or water will induce errors in the distance measurement.

The only viable systems that remain, then, are Laser- and Radar-based. Based on the severity of weather conditions for snowplow operation, including blowing snow from the snow removal operation itself, radar is the best choice. As laser radar operates in the optical range, it is still adversely affected by snow reflections. Calspan [3] concluded the following:

- MMW radar tends to be more robust in terms of weather than laser techniques,
- MMW radar allows for operation in fog, rain, and falling snow,
- and MMW radar was found to be ‘very effective even in rain as heavy as 10 mm/hr’.

Past experiments [15] show rain and snow do not significantly deteriorate MMW radar performance even when sensors were covered with thick snow. This agrees with observations in the current project. MMW radar systems are sufficiently accurate for the required range, approximately 100 m for collision detection and warning. MMW radar was tested in snow and near whiteout conditions in Japan, with the system providing sensing out to 110 m [9]. The biggest concern regarding MMW radar in the operating environment is the build-up of thick layers of ice on the radome. This was encountered during the first year’s testing, and did adversely effect sensing. This issue will be addressed as part of the Phase II development.

The harsh operating conditions of the snowplow environment demand a ruggedized solution for the CWS. Here, a commercially tested unit was preferred. The Eaton Vorad EVT-200 delivers the accuracy and range necessary for the current application, along with the ruggedness

demonstrated through testing of previous generations of radar antennas in commercial vehicle applications. This radar provides range and closing rate to three targets. In addition, through use of the RS-232 standard, the system can be easily interfaced with the industrial PC used for sensing I/O and processing. Thus, this sensor met the robustness needs in a package that could be integrated onto the vehicle in a relatively short time. This sensor does not provide azimuth angle to target, so that lateral target position cannot be determined. However, the team is currently switching to Eaton Vorad's newer sensor, the EVT-300, which does provide azimuth angle, and also provides an integrated gyro to measure vehicle yaw rate, which can then be incorporated into an algorithm to reduce false alarms on curved sections of roadway. In addition, the EVT-300 will track up to seven targets, rather than three. The research team is currently investigating integration of radar, gyro, magnet, and other sensor information in developing a false alarm reduction algorithm as part of the ASP-II development.

The ASP CWS is a forward CWS, with its antenna mounted at vehicle centerline, near the front of the hood. This unit will alert the operator for obstacles in the direct path of the vehicle. As part of ASP-II, a second CWS, i.e. the wingplow CWS, will be added. This unit will be mounted on the right fender of the vehicle. It will detect obstacles in the path of the wingplow, which extends from the right side of the main snowplow body, allowing the plow to clear approximately two lanes worth of snow in one pass. The wingplow CWS will alert for stalled vehicles, bridge abutments, etc., allowing the operator to either steer around the obstacle, or raise the wingplow, depending on the dynamics of the situation. The HMI will present information from the forward and wing CWS systems in a single coordinated interface. Further information on the current ASP CWS can be found in Chapter 7.

### Human-Machine Interface

From the standpoint of the snowplow operator, the Human-Machine Interface (HMI) represents the entire ASP. Methods of sensing vehicle position, obstacle detection, etc., are meaningless to the operator, who will only see the display and react accordingly. Thus, considerable thought was dedicated to the method of presenting this information. Early experiments verified the research team's expectation that the system must provide preview or prediction information to the operator. That is, with a look-down sensing system, it is necessary to project data forward so that the operator has an indication not only of where the vehicle is currently at, but where it is heading in the future. To support this, a steering shaft encoder was added to the system to allow prediction of the future vehicle path. In addition, providing upcoming curvature information allows the driver to determine an approximate steering angle, with minor corrections around this nominal steering angle based on the current and future vehicle locations. The ability to provide prediction is a significant advantage of the magnetic marker-based approach.

The research team investigated available hardware to provide the HMI display for the operator. Initial preference was for a Head-Up Display (HUD), so that any imagery could be presented in the operator's field-of-view, removing the need to look away from the roadway. However, several factors indicated a HUD or similar approach was less than ideal. First, commercially available HUDs that the team could locate do not integrate well into the existing snowplow cab. In fact, many present physical hazards to the operator, as the units must mount very near the operator's head, presenting significant danger in an accident. In addition, there are

known perception problems with respect to HUDs, which can lead to misinformation and hazard [18]. With these factors, as well as a preference for a low-cost system for future commercialization, the research team decided to use a Liquid Crystal Display (LCD) panel as the display for the HMI.

The LCD is mounted near the vehicle's factory-installed radio, just within the operator's peripheral field-of-view. This location keeps the display out of the way for normal operation, while providing an easy check for the operator in conditions of reduced visibility, e.g. during whiteout conditions. The display is divided into two logical areas. The main region displays lateral driver assistance information, including a representation of the current and upcoming roadway curvature, as well as indicators of current and upcoming vehicle position. The left region displays distances to up to three potential obstacles, using a downward moving tape display, which also implicitly conveys rate information to the operator. This portion is for the forward CWS radar, but will eventually convey both forward and wing obstacle information. The guiding principle for the display is to provide the necessary information to the operator without any unnecessary information clutter, and in a fashion that is relatively independent of the actual display hardware. The system must not distract from the operator's normal attention, and must be adaptable to future hardware developments. For a more detailed view of the HMI hardware in the snowplow cab, see Chapter 3. Further detail on the HMI and its development can be found in Chapter 5, and [13].

#### Current System Status

The system is based in Caltrans' Kingvale maintenance fleet on Interstate 80 near Donner Summit. Caltrans operators used it on a regular basis through the winter of 1998-1999, sometimes continually for several days straight during periods of intense storm activity. Additional testing occurred in our partner state, Arizona, on US-180 near Flagstaff. Research engineers continue to analyze and improve the performance of the system, as well as performing preventive and responsive maintenance on the system. Data regarding operator use of the system continues to be collected during ride-alongs by the research team. Analysis of current data appears in Chapter 8, and early indications are quite positive. Early operator feedback has already led to improvements in the HMI display, as well as to some of the ASP system hardware. Testing of the system under actual field conditions has provided a wealth of information regarding system robustness and need for ruggedization. This information clearly could not be obtained from lab or test track testing, or from limited scope demonstration.

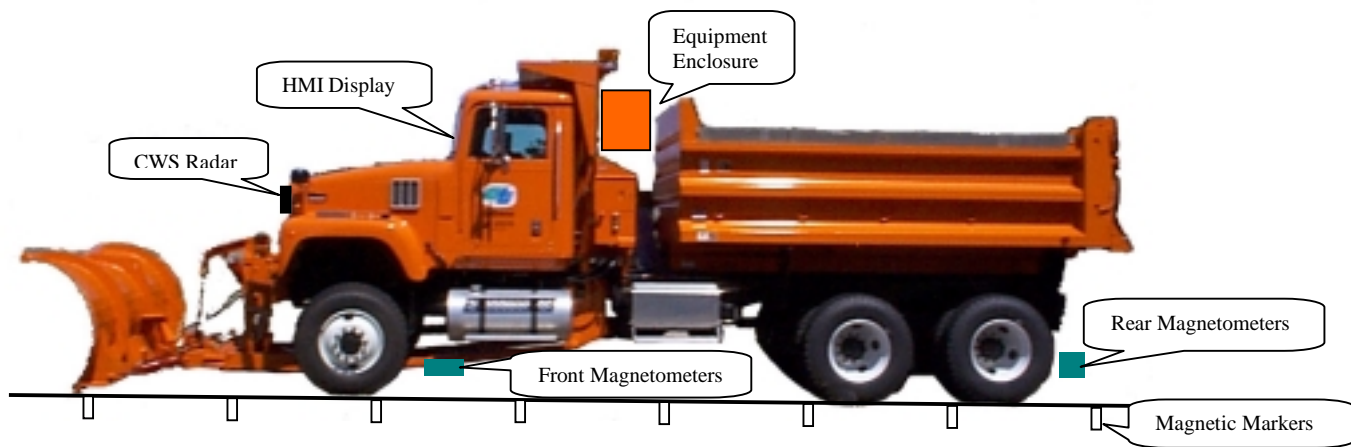




## CHAPTER THREE

### ASP SYSTEM HARDWARE

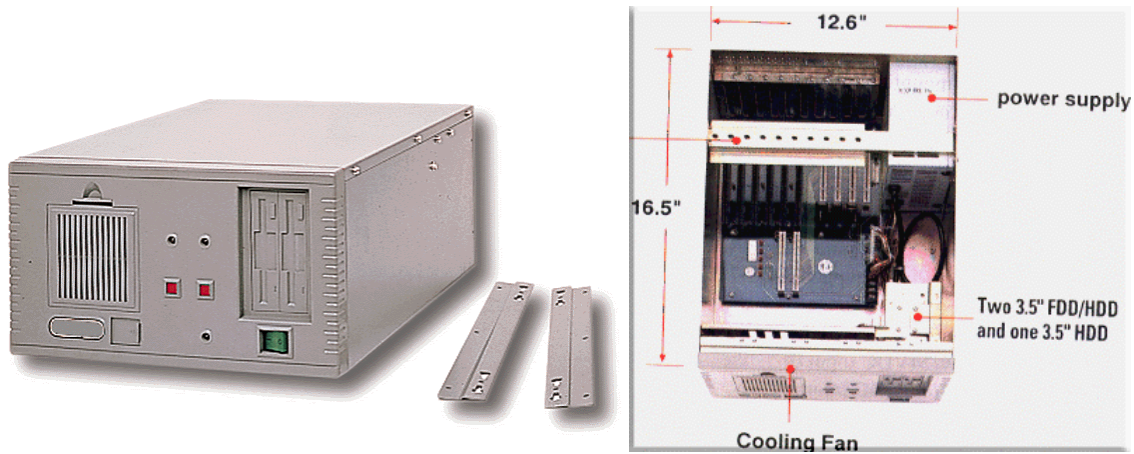
The Advanced Snowplow is composed of several tightly integrated subsystems. Commercial-off-the-shelf (COTS) items are employed when possible to reduce both time and cost. However, a few subsystems are custom designed and fabricated. The ASP system may be segmented into six subsystems: computing unit, human-machine interface (HMI), sensing system, sensor interface electronics, power supply system, and diagnostic laptop. Nearly all components, except sensors and HMI, are located inside the weather-tight equipment enclosure behind the truck cab, shown in the schematic in Figure 3-1.



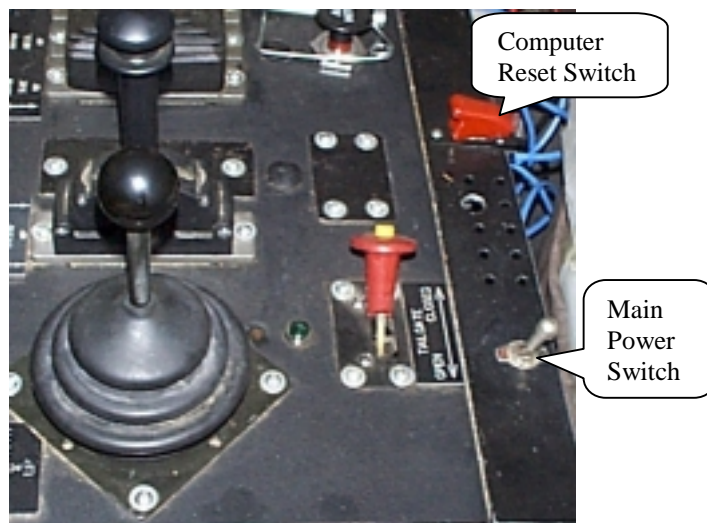
**Figure 3-1: Equipment Location Layout Schematic**

The computing unit consists of an industrial computer chassis with a passive backplane, an Intel Pentium II 333 MHz single board computer (SBC), two National Instrument I/O cards, a ConnectTech Flex4 4-port serial adapter, a Netgear FA310TX 10/100 BaseT Ethernet card with DEC Tulip chipset, and a Quantum 3.8 GB EIDE hard disk. The computer is located at the center of the equipment enclosure under the sensor interface boards. The industrial computer chassis is an IPC-10XP from CyberResearch, Inc., and has a 10-slot passive backplane that can accept 5 full length ISA, 4 PCI, and a 1 PICMG CPU card slot, and requires 110 VAC input. The PICMG SBC has an Intel Pentium II 333 MHz CPU, 128 MB EDO RAM, onboard ATI video with 4MB video RAM, 2 serial ports, and a PCI EIDE controller. A Quantum Fireball 3 GB EIDE hard drive was used to store the QNX 4.24 Operating System, controller software, and diagnostic data. A Quantum hard drive was chosen because of its better specifications for operating in a vibratory environment. In addition, a National Instruments AT-MIO-64E data acquisition board was used to read in data from the magnetometers and any other analog sensors. Moreover, its digital input/output ports were used to read any user inputs. Furthermore, a National Instrument PTIO-10 timer board was also used. Its primary function was to interface with the Hall-effect speed sensor on the vehicle transmission, and its digital input ports were used to detect any magnetometer failures. A ConnectTech Flex 4 four-port serial adapter was added to communicate with the GPS, radars, and steering wheel encoder. Most components

were chosen based on device driver support for QNX RTOS. The two National Instrument board device drivers were written by PATH. Other drivers are available either from QNX or the original manufacturer.



**Figure 3-2: Industrial Computer Chassis Used**



**Figure 3-3: System Power and Reset Switches**

The HMI system display is an ultra-high brightness LCD panel mounted inside the snowplow cab with a RAM -mount and three control switches. The main power switch for the driver assistance system and the computing unit reset switch are both located at the rear end of the center console, illustrated in Figure 3-3. The computing unit reset switch is a momentary switch with a red safety switch cover to prevent accidental activation. The main power switch located next to the red switch cover is a locking switch and should be left in the “ON” position so that the driver assistance system will come on whenever the snowplow ignition key is turned. A programmable time delay circuit was added to turn off the system ten minutes after the ignition is turned off. In addition, the cab contains a momentary push button "log" switch (also referred to as the “concern” button), connected to a digital I/O port of the AT-MIO-64E board. The computer logs all essential data when this switch is pushed. The LCD’s location is shown in

Figure 3-4. The HMI LCD panel, which displays the computer VGA signal, is produced by Computer Dynamics, and provides 640 x 480 resolution and a maximum brightness of 900 nit, and requires regulated +5 and +/- 12 VDC power input. The driver may adjust brightness and contrast by turning a knob or pushing a button attached to the display. A custom enclosure was designed and fabricated to better fit the dash with minimal interference with other controls at the dash. The mount location and hardware are shown in Figure 3-5.



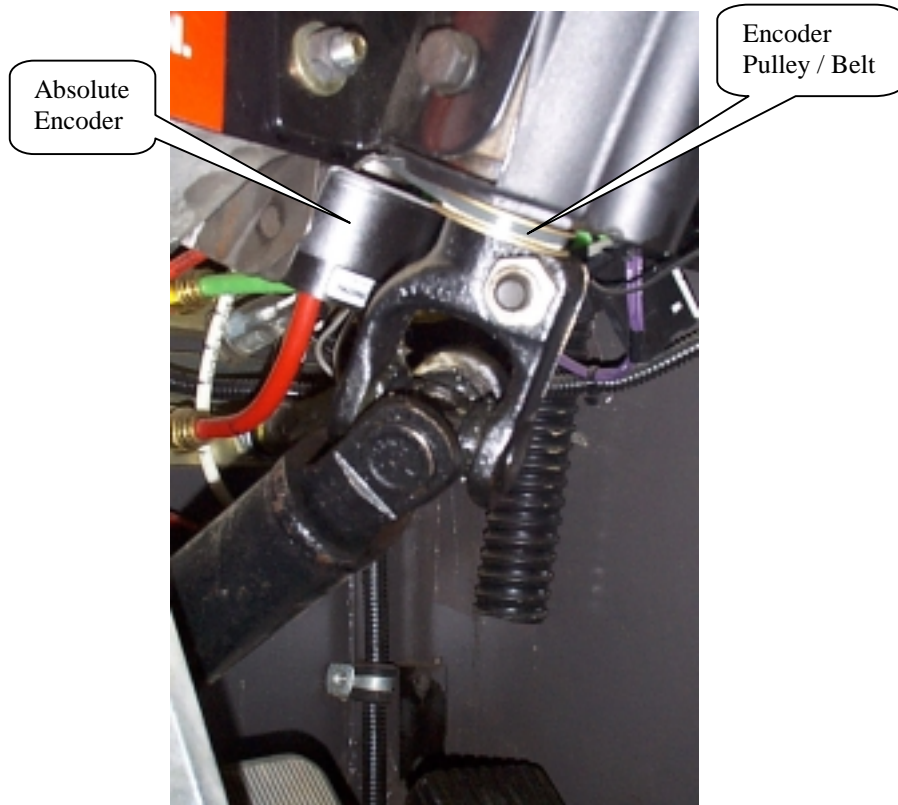
**Figure 3-4: System Layout, Including LCD Panel for HMI**



**Figure 3-5: Hardware Mount for the LCD Panel**

The sensor system consists of a GPS receiver, absolute encoder, radar, and a series of magnetometers for magnetic marker detection. The Novatel RT-20 GPS receiver connects to the

computing unit via a serial port, and to an RF modem for differential corrections. It provides absolute vehicle location information to the computer; this information from the GPS unit was not used in the main functions of the ASP, but is being used for ongoing feasibility evaluation of GPS in mountainous regions. In addition, an absolute encoder, shown in Figure 3-6, was added to measure the steering wheel position, for use in predicting future vehicle position. It communicates with the computer through a serial port and provides steering wheel location at ten Hz. The encoder has a resolution of 0.1 degree. The steering wheel resolution depends on the gear ratio between the steering wheel and the encoder. The current gear ratio is 1:3. The collision warning radar communicates with the computer via a serial port. Further collision warning radar details are discussed in Chapter 7.



**Figure 3-6: Absolute Encoder for Steering Wheel Angle Sensing**

The magnetic marker sensor consists of two banks of seven magnetometers. The sensors used in the system are the Applied Physics Systems (APS) APS-535 fluxgate magnetometer. The first bank of magnetometers is mounted behind the front wheels (see Figure 3-7), and the second bank is located behind the rear wheels (see Figure 3-8). All magnetometers are about 20 cm (8 inches) above the ground. Lowering the sensors would achieve a better signal-to-noise ratio. However, the sensors must be high enough so that the rare-earth magnetic markers (used in bridge structures) will not saturate the sensors. Each magnetometer is mounted 30 cm apart laterally within each bank and has an operating range of +/- 15 cm from the center of the sensor element. Therefore each bank of magnetometers yields a combined lateral sensing range of +/- 1.05 meters from the center of the vehicle. The exceptionally large sensing range is required because snowplow operators often drive with up to a 2-foot offset when driving in an echelon

snowplow formation. The magnetometers are encased inside a sealed enclosure to prevent any water damage. Each magnetometer output channel is connected to the sensor interface board. Extended details on magnetic marker detection and signal processing can be found in Chapter 6 and reference material.



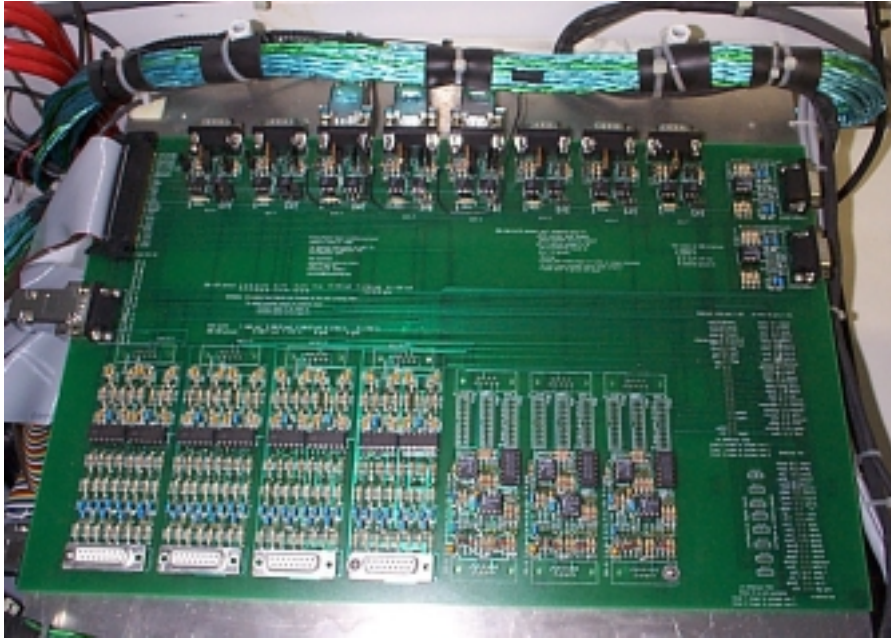
**Figure 3-7: Center Portion of Front Magnetometer Sensor Array**



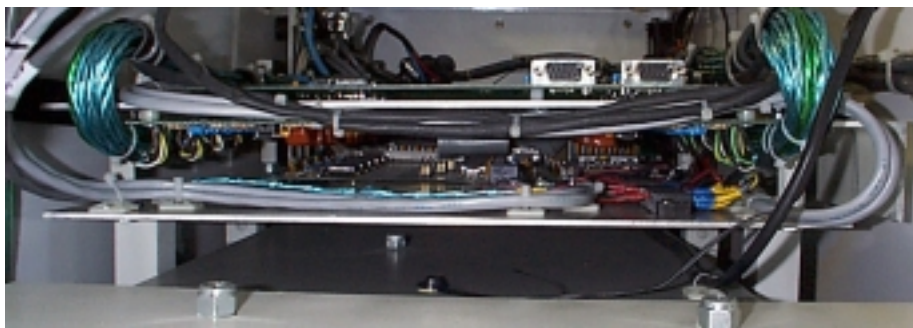
**Figure 3-8: Rear Magnetometer Sensor Array**

Sensor interface electronics provides signal conditioning for the analog sensor output as well as overload protection for digital I/O and analog output from the AT-MIO-64E and PTIO-10. The three sensor interface boards, designed by PATH, are located above the computing unit. Each board provides an interface between the sensors and the National Instruments boards. The magnetometer outputs are fed through a low pass filter with an effective bandwidth of 140 Hz and connected to the upper 48 A/D channels of the AT-MIO-64E. The anti-aliasing filter must be selected rather carefully with the intended application and sampling rate in mind. The present

cutoff is only marginally acceptable in the presence of low frequency interference. In addition, the pulse output from the Hall effect speed sensor at the transmission is also connected to the PTIO-10 sensor interface board. Revisions to the sensing and interface electronics are being considered in future research.



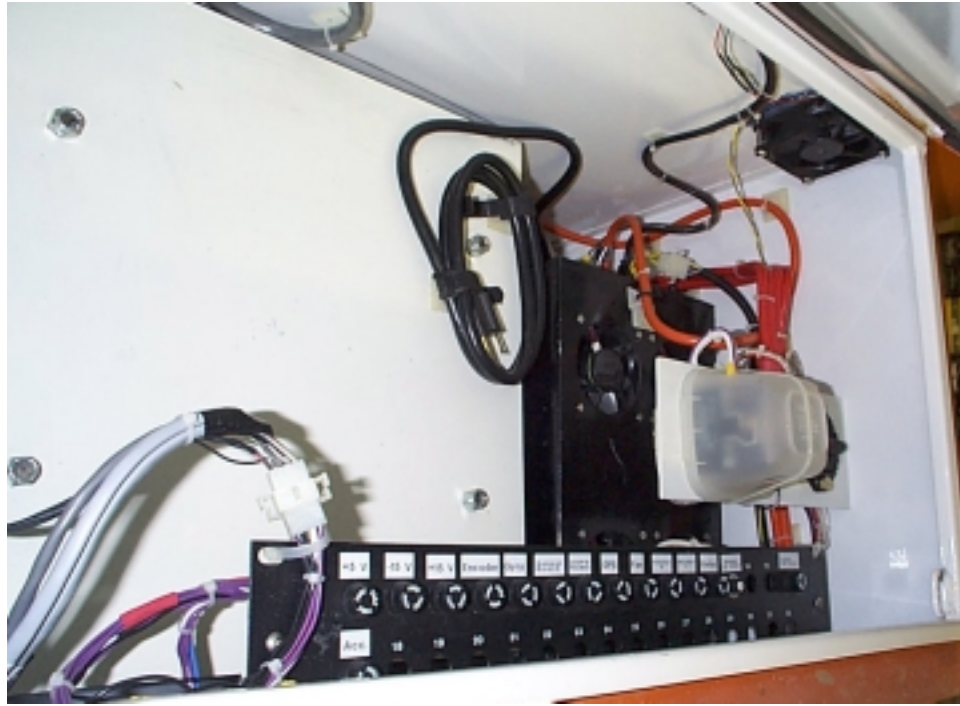
**Figure 3-8: Custom Sensor I/O Board, Top View**



**Figure 3-9: Side View of Sensor I/O Boards**

The power supply system provides power backup and required voltage regulation, power supply conversion, and fuse protection for all components. The power subsystem consists of 110 VAC inverter, a 12 V to +/-15 V DC-DC converter, transformers, backup batteries, switching power supply, relays, and a fuse system. Four 60 Amp-hr sealed gel lead-acid batteries are used for the power backup. Battery backup may be eliminated if the system does not require operating for an extended period of time when the engine is off, i.e. it is only required for a research platform, and it is not needed for a final production unit. Furthermore, the power system will be more efficient if the inverter is replaced by DC-DC converters. However, this will require more research on the exact power requirements of each component, and locating the

necessary DC-DC converters. A custom-designed power system is required for the final production unit.



**Figure 3-10: ASP Power Supply System**

Finally, the diagnostic package includes a 10BaseT hub and a laptop computer running the QNX 4.24 operating system. A Toshiba Tecra 740CDT laptop and Linksys EC2T PCMCIA (PC Card) network card were chosen based on QNX compatibility. The diagnostic laptop is not connected during normal operation, and is used only during software updates and system debugging.





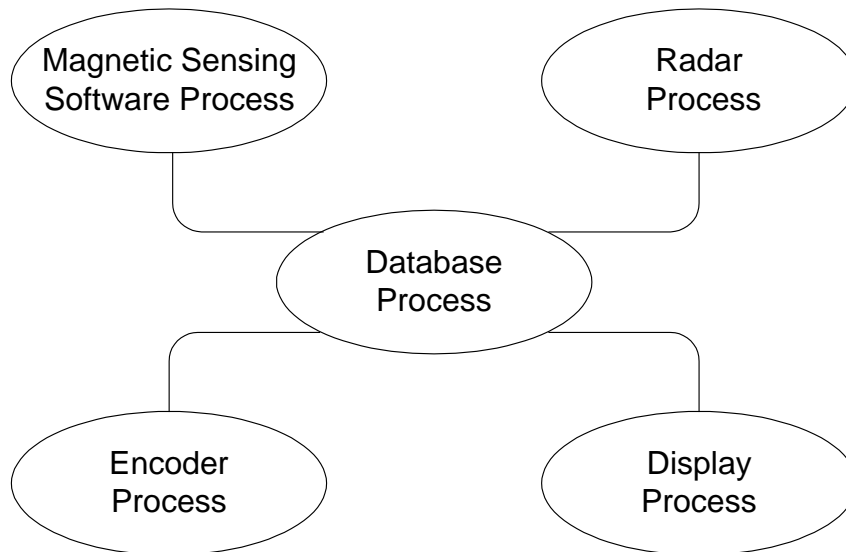
## CHAPTER FOUR

### SOFTWARE ARCHITECTURE

The ASP software architecture is driven by the need for real-time operation. The ASP travels at speeds up to 13.4 m/s (30 mph), detecting the vehicle's present location, predicting its future location, detecting obstacles in the vehicle's path, and displaying all the information live on a Human-Machine Interface (HMI). Because of the real-time nature of this operation and the volume of computations necessary to evaluate approximately ten magnetic markers per second (~23 markers/sec at 26.8 m/s, 60 mph) and ten radar messages per second, it is essential that the different program processes that perform these operations do not interfere with each other.

To solve this problem, the software architecture is divided into processes of varying priorities. The magnetic sensing software, which senses the magnets embedded in the roadway and determines the vehicles present and future locations, is given the highest priority. All other software processes are given lower priorities. The processes are ranked in priority according to the real-time needs of the system. The five processes, shown in the system diagram in Figure 4-1, listed in order of decreasing priority are:

- Magnetic Sensing Software Process
- Database Process
- Radar Process
- Encoder Process
- Display Process



**Figure 4-1: System Diagram**

The priorities were determined based on the importance of the process in maintaining the essential functions of the ASP. Although the display is the end-result of all other functions, if the underlying processes aren't functioning, the displays information is irrelevant. Therefore, though it may seem paradoxical to give the display the lowest priority, this results in the best information being displayed. This is more evident when one considers that the underlying processes update at about 10 Hz, while the display updates at a much slower rate.

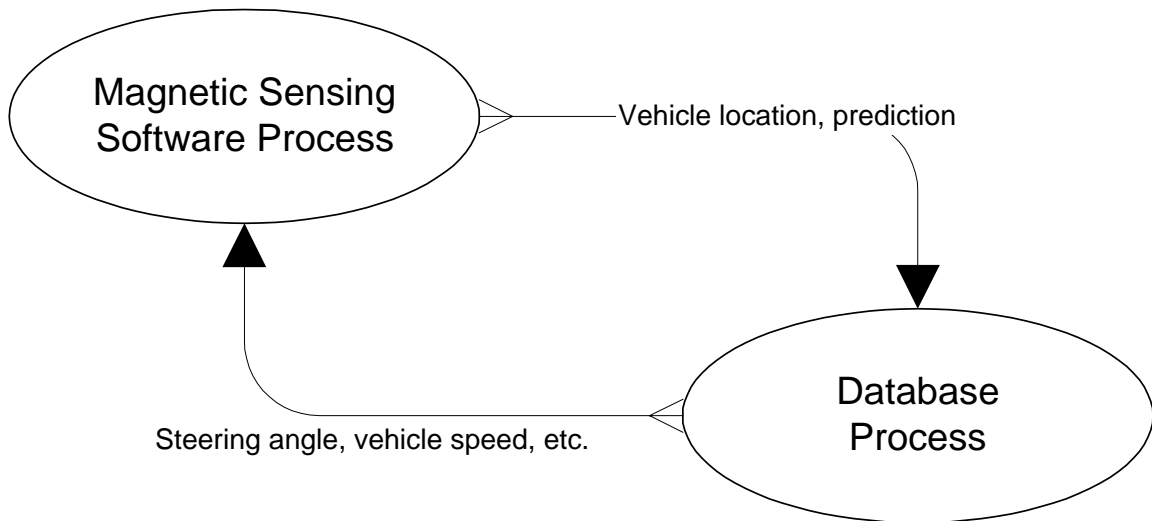
### Magnetic Sensing System Process

The Magnetic Sensing System (MSS) process determines the vehicle's current position in the roadway and the vehicle's future location based on current vehicle and roadway data. The MSS determines the vehicle's position on the roadway using data from two sets of magnetometers, devices that measure magnetic field strength, as described in Chapter 6. Each set (front and rear) contains seven magnetometers, evenly spaced and mounted in enclosures located under the ASP.

Magnets are embedded in the highway infrastructure in the center of the lane at 1.2 m spacing. The magnetometers sense the magnets and send signal strength information to the computer. The MSS then determines the vehicle's position relative to the magnets by analyzing the field strength of the magnet on the seven magnetometers. The magnet is located between the two magnetometers with the highest strength readings. The exact location of the ASP over the magnets can be determined with very high accuracy based on this method. If the vehicle is centered over the magnets then it is in the center of the lane. Chapter 6 provides the details of the magnet signal processing algorithm.

By varying the polarity of the magnets in the roadway (North vs. South pole) the magnets can represent binary code (ones and zeros). Information can then be coded into the roadway in much the same way as computers use binary serial data streams. This information tells the vehicle where it is on the roadway (which mile marker, which exit, etc.), what are the upcoming road curvature changes, as well as other non-position critical information.

The MSS then uses the roadway curvature information provided by the coding, as well as the vehicle's current information (speed, trajectory, steering angle, location on roadway) to predict the vehicle's position at a future location if it were to continue on the same trajectory. The prediction information is displayed on the in-vehicle display, which dramatically improves the operator's ability to keep the vehicle on the desired path. The MSS process is shown in Figure 4-2.



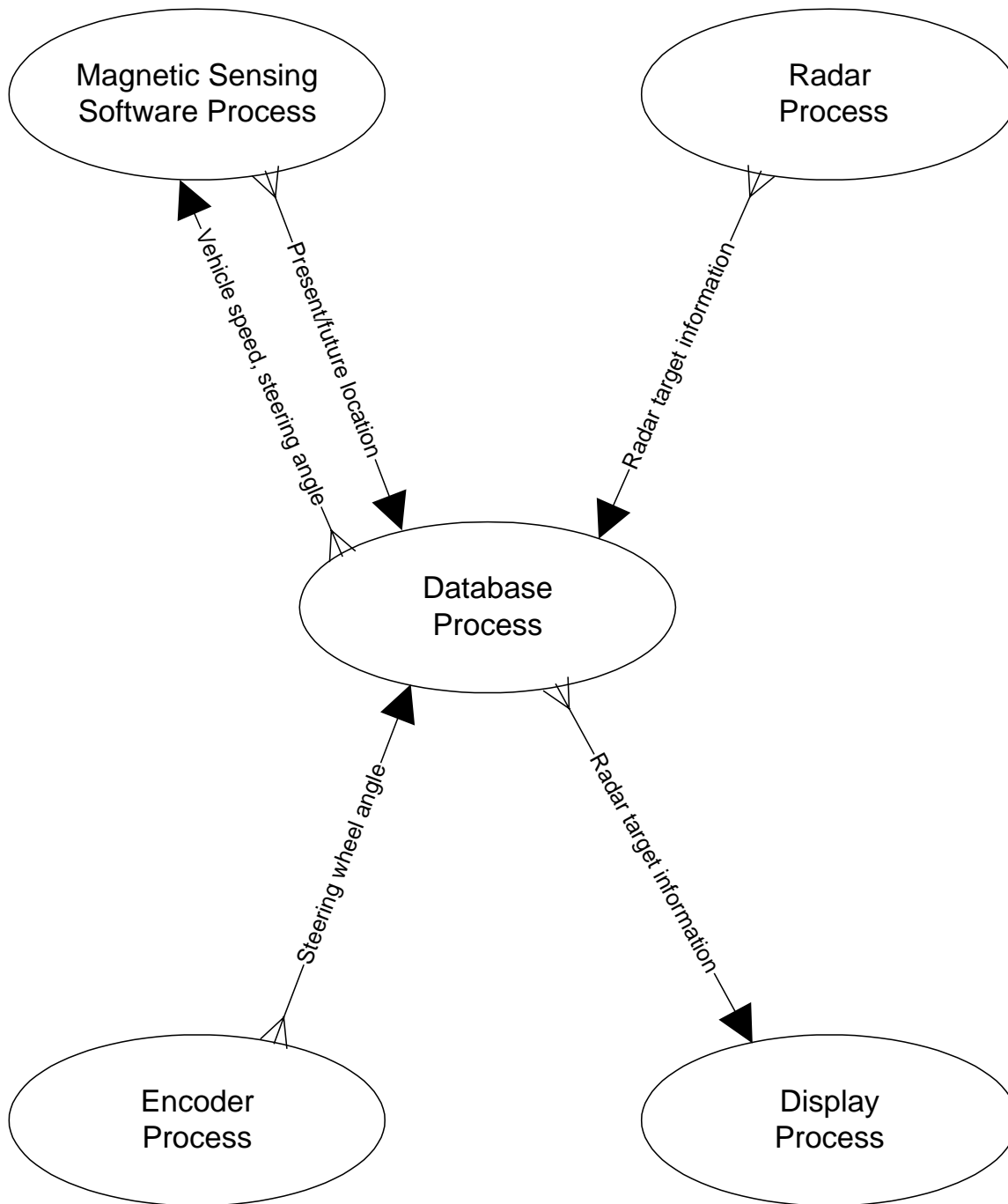
**Figure 4-2: Magnetic Sensing Software Process Diagram**

The vehicle's current position information is not very useful by itself for controlling the location of the vehicle. One could simulate this approach by cutting a hole in the floorboard and attempting to drive by staring at the ground under the vehicle. This would obviously be a very difficult task that would not be very successful. The purpose of the prediction information is to mimic a human's way of driving. Humans look at the road ahead and use their senses to estimate where their vehicle is heading. If they see a curve ahead and realize that their current trajectory would cause the vehicle to go off the road, they compensate accordingly. The prediction information does exactly the same thing, showing (on the in-vehicle display) the future location of the vehicle based on the current trajectory, giving the operator the information needed to use predictive input, thus allowing the operator to better maintain lane position. Further detail of the magnetic sensing system algorithm can be found in Chapter 6.

#### Database Process

As noted above, to allow prioritization of functions, the ASP software is split into several processes that run simultaneously. A database process was created to coordinate the processes and share information. The database can be written to and read from by all of the processes. Each process writes information that needs to be transferred into the database, then the process that needs the data reads it from the database. For any database variable, only one process is allowed to write the data, thus assuring synchronization and data integrity.

Data is stored in the database using named variables. Processes access information for the desired variable, or write information to it. The processes write and read data at about 10 Hz. Simultaneous read/write problems are handled automatically and more than one process can access the database at the same time. The database process, including data flow information, is shown in Figure 4-3.



**Figure 4-3: Database Process Diagram**

Using the database dramatically improves the performance of the ASP software. The database is very robust and not prone to stalling, unlike other forms of interprocess communications, such as pipes.

### Radar Process

The radar process reads range, rate, and target ID data from an Eaton Vorad radar unit (EVT-200) and uses that data to generate collision warning information. Data is read at 10 Hz and is processed if any targets are detected. The EVT-200 model radar can detect and track up to three targets. The radar process analyzes all targets, determining which is the most critical.

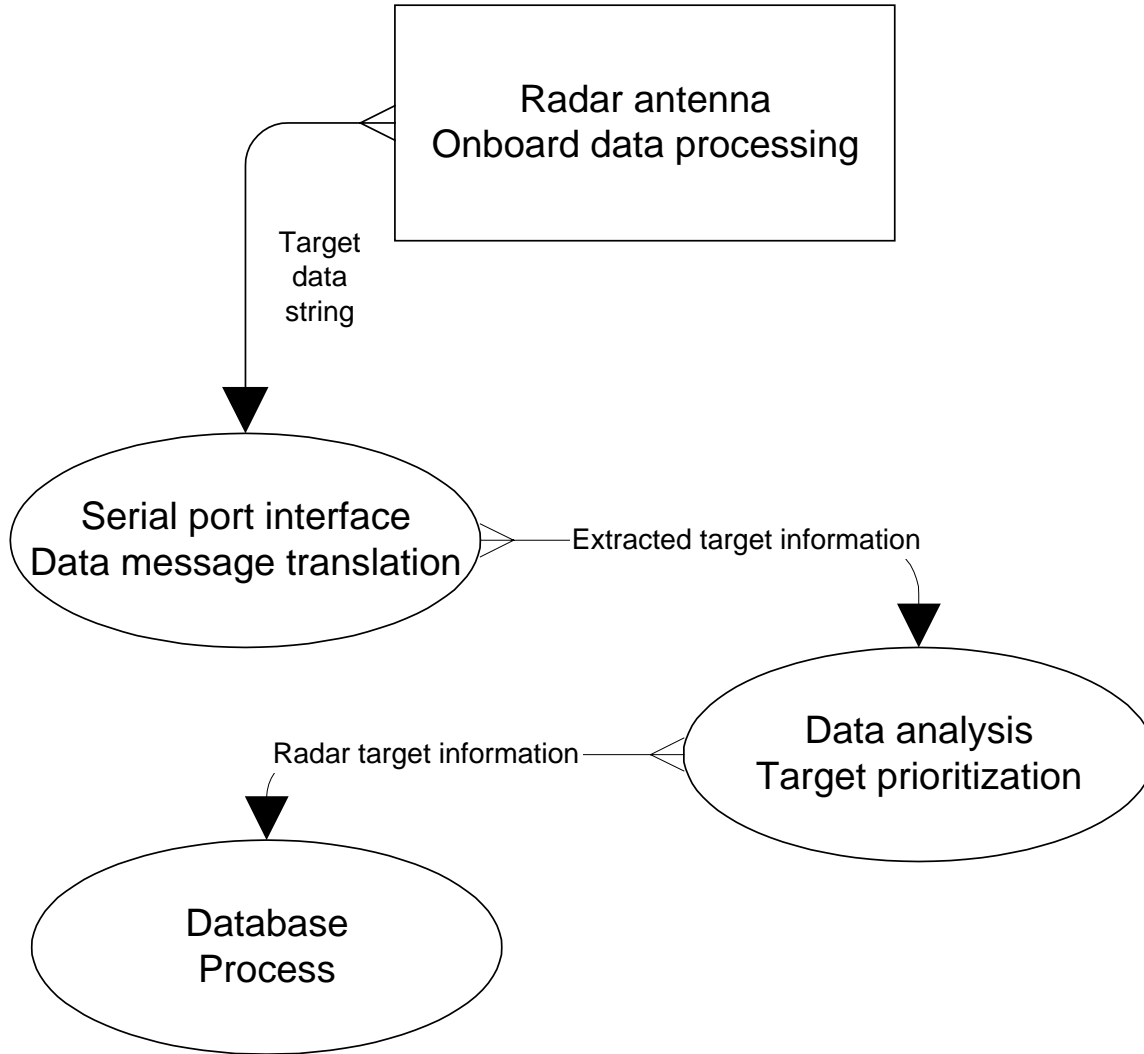
Targets are rated by distance from the ASP and time-to-impact with the ASP. Targets within a close “critical range” are assigned high priority. Outside the critical range, targets are rated first by time-to-impact, and then by distance from the ASP. The critical range is defined as the range from the plow where targets must be seen by the operator, even if other targets have a shorter time-to-impact. This range is determined based on human factors evaluations and driver satisfaction with the display information’s agreement with objects within the driver’s visual range.

For the ASP, the maximum range of the radar unit is 100 m and the critical range was set at 25 m. As relative velocity is negative for an obstacle approaching the plow, time-to-impact is given by

$$\textit{Time-to-impact} = \frac{(\textit{distance from plow})}{- (\textit{relative velocity})} \quad (5-1)$$

Note that objects moving away from the plow will have negative time-to-impact.

Once targets are prioritized, they are sorted to determine location on the display screen. The screen can show up to three targets, using three downward moving bars (or “tapes”) located in the left panel of the display (more information is given below). Thus targets can have left, center, or right position. Based on the information for each target, the left tape is for the fastest approaching objects, such as vehicles in the approaching lane (for two-lane highways) or snow banks on curved sections of road. The right tape is for objects with lowest relative velocity and close proximity to the plow, typically vehicles that the plow is following in its lane. The center tape is for targets that do not meet these criteria. In the Phase II CWS, using the EVT-300 sensor, tape position will correlate directly with lateral target position, so that the interface will be more intuitive for the operator, and the CWS will operate in a universal fashion for envisioned road types. The radar process is depicted in Figure 4-4.



**Figure 4-4: Radar Process Diagram**

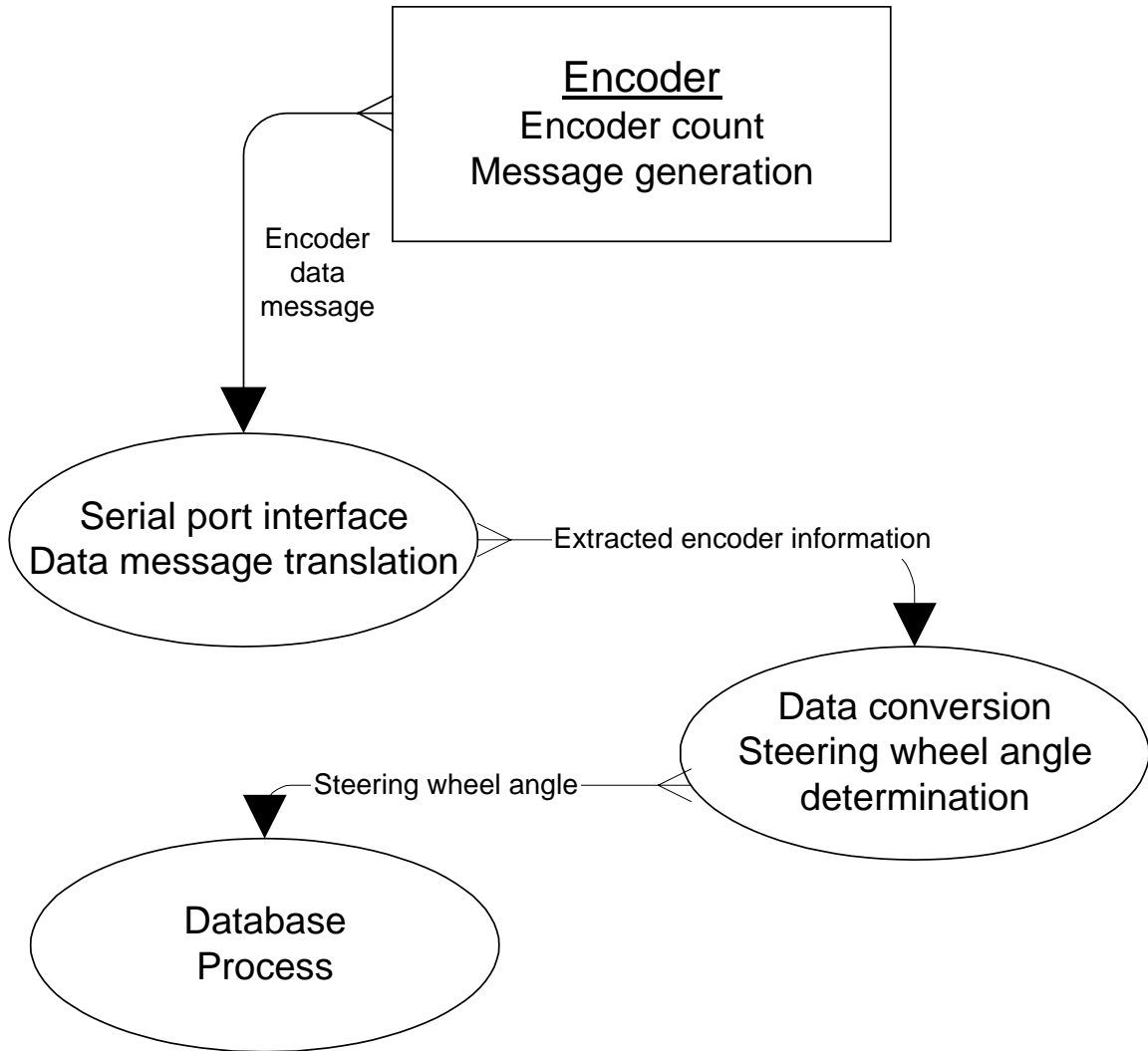
The distance to each target (meters) is sent to the database in three variables: left target, center target, and right target. Currently, the left, center, and right designations do not actually represent the target’s physical location with relation to the plow, but rather the location on the vehicle’s display screen, as will be explained below.

#### Encoder Process

The encoder process reads information from an absolute encoder connected to the ASP steering column. The encoder sends a turn value from 0 to 3600 for a single turn of the encoder. Using a conversion factor, 0.0325 degree per encoder count, to convert from the encoder count to the vehicle’s steering wheel angle, the encoder process outputs the vehicle’s current steering wheel angle.

The program also tracks multiple encoder turns. When the vehicle is first started and enters a lane instrumented with magnets, the MSS process reads a series of magnets and obtains the

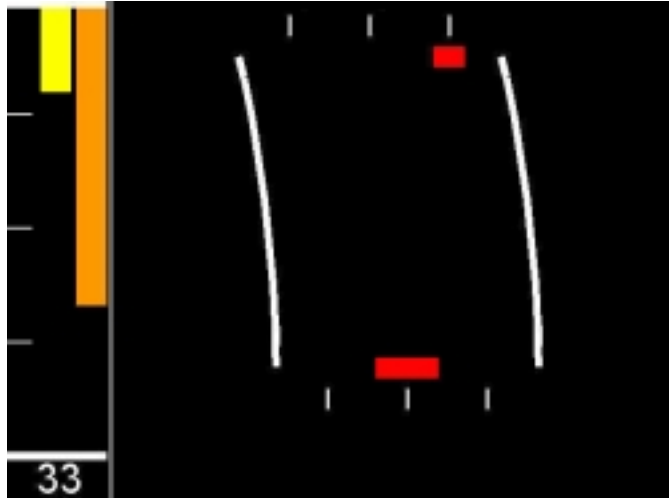
vehicle's trajectory, from which it estimates the steering angle. When the program finds the steering angle between  $\pm 60$  degrees, it zeroes the encoder turn count. Once the count has been initialized, the encoder program keeps track of the number of turns and in which direction they are made, thus enabling the program to give accurate steering wheel angles for multiple turns of the encoder. The database steering wheel angle is updated regularly, and is used by the MSS to predict the vehicle's future location, a key aspect of the lateral assistance portion of the HMI. The encoder process is shown in Figure 4-5.



**Figure 4-5: Encoder Process Diagram**

#### Display Process

The display process creates a user-interface display based on the information generated by the radar and MSS processes. As shown in Figure 4-6, the display process generates radar information in the left panel of the screen, and provides MSS roadway information in the main portion of the screen.

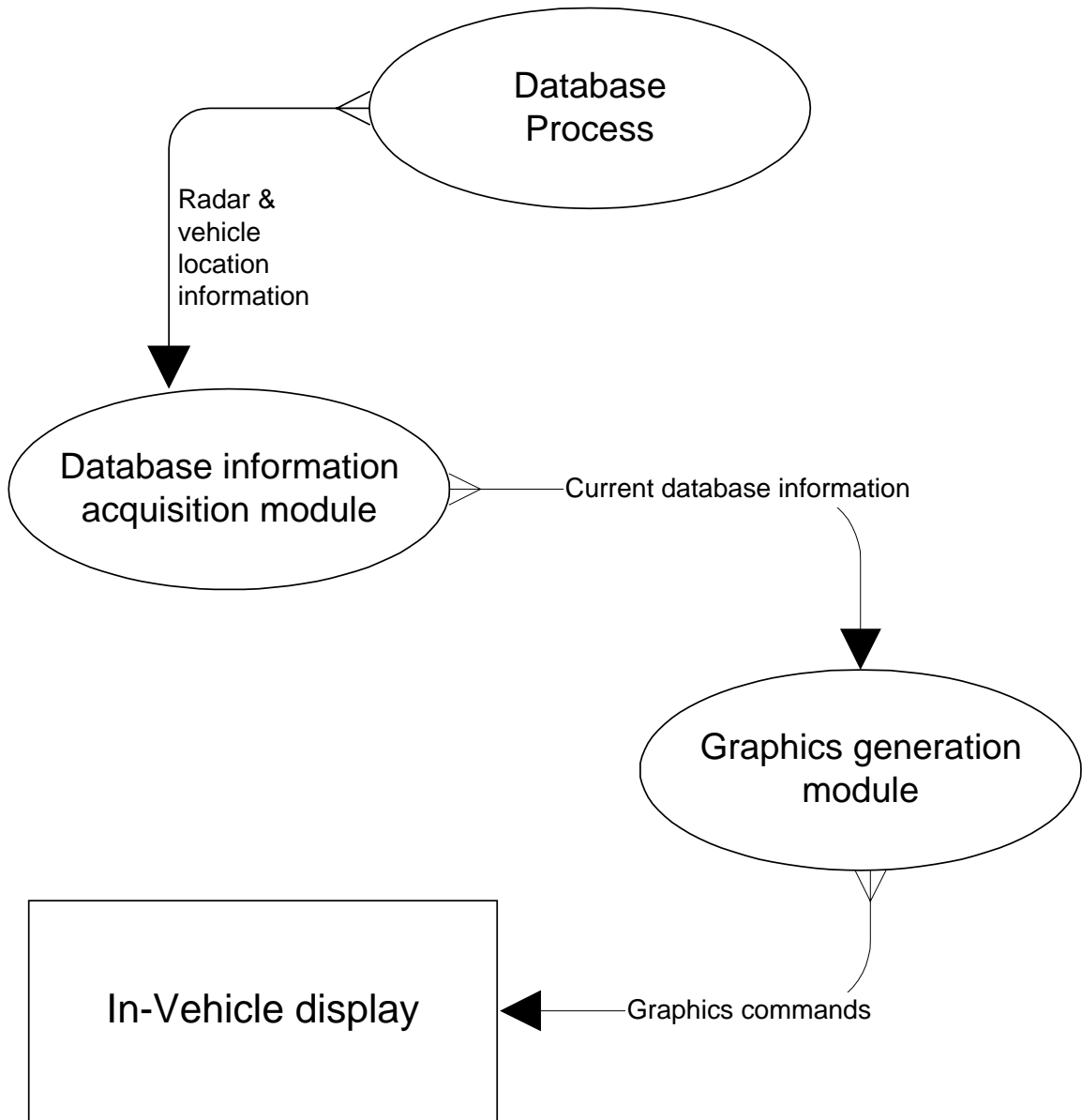


**Figure 4-6: Screen shot of the in-vehicle display.**

Up to three radar targets can be displayed on the screen, each represented by a downward moving bar or “tape”. The radar process tracks up to three targets, so the display process was designed to display up to three targets. The three columns on the radar portion of the display represent three distinct targets. Targets are displayed starting from a distance of 100 m. As the targets approach the ASP, the bar representing the target grows longer, approaching the bottom of the screen. The distance (meters) to the closest target is displayed numerically at the bottom of the screen. Progress of the bar toward the bottom of the display implicitly provides rate information to the operator.

The right panel of the display, comprising the majority of the screen real estate, provides lateral position and roadway geometry information. The tick marks at the top and bottom of the lane represent logical offsets, based on the need for up to a two foot offset from lane centerline during normal plowing operations. The vertical curves represent the upcoming roadway curvature. The horizontal bar at the bottom of the display represents the current plow position, while the smaller horizontal bar at the top of the display provides a predictor of future vehicle position, based on current position, roadway geometry, and plow steering angle. Further details of the HMI display are provided in Chapter 5. The display process diagram is shown in Figure 4-7.





**Figure 4-7: Display Process Diagram**



## CHAPTER FIVE

### HUMAN-MACHINE INTERFACE

#### Introduction

#### **Overview of the Problem**

The Advanced Snowplow (ASP) project was initiated to assist snowplow drivers during the harsh conditions often experienced over Donner Pass on Interstate 80 in the Lake Tahoe region. For an overview of the system concept see [10, 14]. Snowplow drivers along this route experience some of the heaviest snowfall in the United States and often encounter whiteouts due to the sheer quantity of snow as well as blowing winds in the mountainous terrain. During the frequent winter storms, drivers must operate snow removal equipment 24 hours a day since Interstate 80 is the major land conduit into northern California.

Besides pushing snow, a snowplow driver has to give simultaneous attention to a set of secondary tasks. First and foremost, they need to stay on the road, a somewhat difficult task during whiteout conditions. Experienced drivers learn to feel the road surface through the plow blade. The change in texture or pitch of the shoulder can provide subtle vibration cues through the truck body and the steering wheel. Traditional wisdom would recommend that the driver come to a stop and wait out periods of low visibility. However, in mountainous terrain drivers are often reluctant to do this since stopping on an incline or in a potential avalanche area is undesirable, and there is strong motivation to keep the roads clear.

A subtask of staying on the road is maintaining a desired position within a lane. Even during periods of good visibility and without deep snow, this can be difficult since road markings are not easily perceived (Figure 5-1). In some regions (such as Donner Pass) a team of plows is used in an echelon formation. The position of the lead plow is especially important. The drivers following behind will adjust their lateral position based on the lead plow. Improper positioning by the lead plow can lead to inefficient road coverage and may lead to clean up runs by the team.

Another fundamental task is to avoid driving the plow into an obstacle, e.g., a car stuck in a drift. In low visibility conditions, an experienced plow driver will feel the plow blade make contact with such an obstacle. Since the driver has typically dropped to a very slow speed, the initial contact is usually not extreme. Furthermore, the driver can stop the plow quickly by dropping the plow blade into the ground. This stopping technique is even more effective when the plow is equipped with a wingplow (a large plow mounted on the side of the truck). Even with this rapid stop, damage the obstacle and/or the snowplow is very likely.

The driver's basic duties are further affected by a series of potential hazards. Low visibility can occur due to whiteouts, malfunctioning or iced headlamps, or obscured windshield. Perception of the road edges is affected during deep snow conditions since the only indications of the edges are tall snow stakes placed just off the shoulder. Additionally, icy roads, plow vibration, and icepacks can adversely affect vehicle dynamics. When a wingplow is in use, low ballast (due to sand depletion) can also lead to extreme torque on the truck. These difficulties can easily lead to elevated levels of mental workload and stress.



**Figure 5-1: A Typical View from the Cab of a Snowplow at Donner Pass. A Forward Plow Is Seen at the Left Shoulder, the Lead Plow Is Barely Visible.**

### **Human Factors Goals for the Advanced Snowplow Project**

The primary human factors goal of this project was to provide to the drivers with information on lane edges, lateral position, and potential forward collisions so that they can navigate more safely, efficiently, and confidently through low visibility conditions. A secondary goal was to provide lateral information in a manner that would make positioning the lead plow easier during deep snow scenarios.

#### Prototype Development

### **Human-Machine Interface Design Considerations**

The characteristics of interest for the human-machine interface (HMI) were the look-ahead distance, the road representation, and the presence of a prediction marker. The look-ahead distance is the longitudinal location that the display is describing. The road can be described with a bar (a single lateral slice at a set distance) or some iconic representation of the road scene. Prediction of future position and/or orientation can be supplied using internal maps, vehicle orientation, speed, and current lateral position. The first mini-study examined the impact of look-ahead distance while the latter characteristics were examined in the second mini-study.

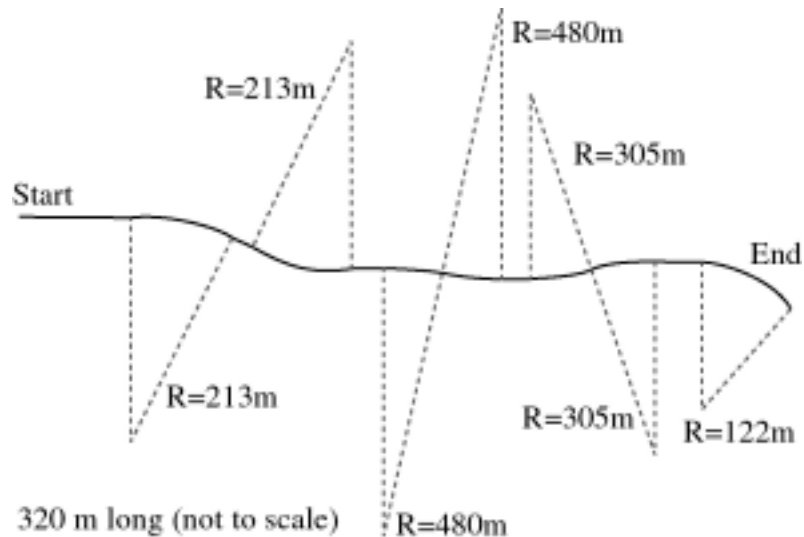
### **First Mini-Study: Bar Displays**

A simple visual display that would only require a quick glance was a key design goal. Auditory displays were not considered since the cab interior is often noisy during operation.

A preliminary mini-study using a Buick LeSabre was conducted to support the HMI development. Simple modifications of an Automated Highway System equipped Buick were

made by disabling the steering actuator action and processing the lateral deviation information to reflect different look-ahead distances. The lateral deviation from the centerline was presented on a small bar in a Delco Head-Up Display (HUD).

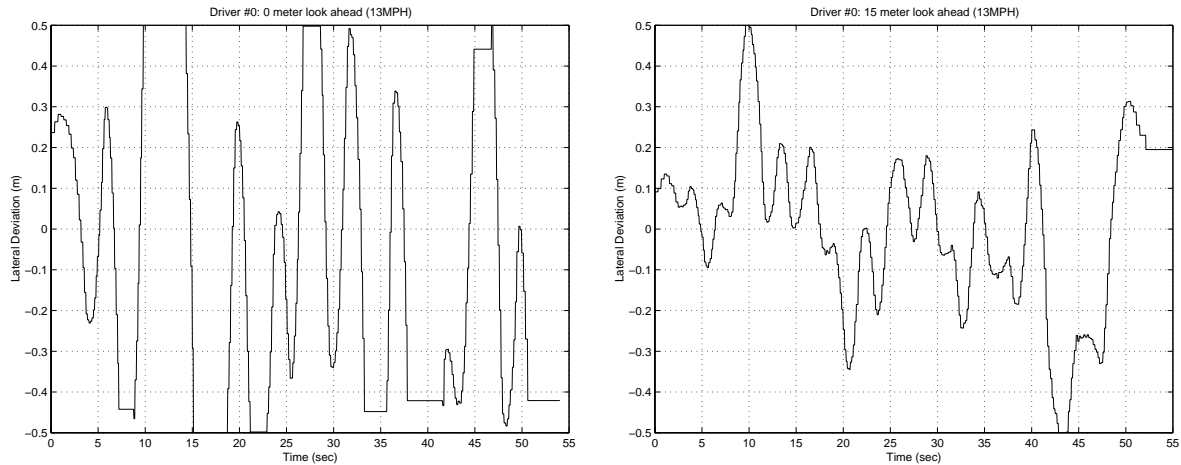
To test the bar display, three members of the development team who had not been exposed to the display were enlisted as drivers. Drivers were tested with a covered windshield (simulated white-out) using 0, 5, 10, and 15 meter look-ahead distances. The speed was fixed and automated at 6 m/s (13 mph). All driving was done on a short, closed-track course. All mini-studies were conducted on the PATH Richmond Field Station track, shown in Figure 5-2, which is about 320 m long and includes several short curves. Data was sampled at 33 Hz.



**Figure 5-2: PATH Richmond Field Station Track**

Figure 5-3 shows lateral deviation results for two driving runs with look-ahead distances of 0 and 15 meters, respectively. Distances of 5 and 10 meters showed a smooth progression between the two results shown. The results indicate that the larger look-ahead distances lead to better lane-keeping performance. Off-scale events indicate the centerline magnets are beyond the range of the car's magnet sensors, i.e. the car is out of the lane. As seen in the left plot of Figure 5-3, the car was out of the lane approximately nine times over the run. For the right plot, the vehicle left the lane briefly only twice. Lateral deviation is the lateral displacement from the center of the lane as measured by the sensors under the front bumper of the car. This measure will be referred to as front lateral displacement in later sections.

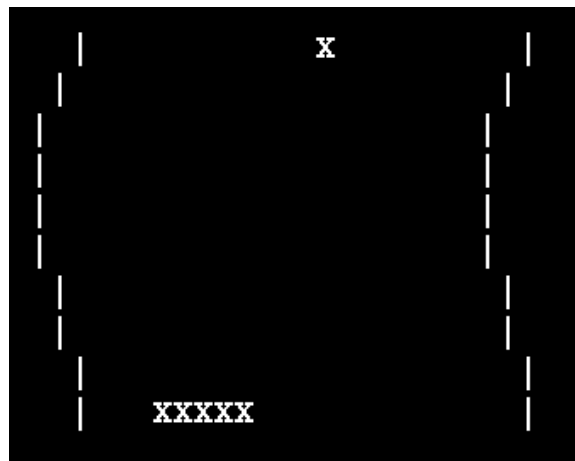
Drivers commented that this display method required high concentration levels. It was felt that the addition of one or two additional bar code indications, reflecting the road and vehicle trajectory change, would help drivers improve performance.



**Figure 5-3: Lateral Performance of Subject 0, 0 and 15 Meter Look-Ahead Distances**

### Second Mini-Study: Road Images

The need for a respectable look-ahead distance and the concern over the unacceptable amount of driver stress led to the desire to examine displays with multiple bars. The inclusion of more rows allowed miniature, iconic road scenes to be examined. This design was reinforced by initial contacts with the snowplow drivers who suggested a visual display that indicated lane position and road edges. Figure 5-4 presents an example of one of the text-based prototype displays that were created.



**Figure 5-4: A Text-Based Representation of the Road**

A prediction feature was also added into the top line of the display. The single “X” showed the lateral position 10 m ahead corresponding to the magnitude and direction of the steering wheel angle (turn left, the X moves left). The display represented a distance of 10 m with a one-meter width between the “curbs.”

To assist final selection of relative motion, two versions were created. One showed the scene with the car (“XXXXX”) fixed at the same location on the screen (fixed car). The other fixed

the curbs on the bottom row at the same location while the car moved side to side (fixed road). Since the display never went beyond the computer window edge, some drivers may have perceived the two displays as being equivalent.

Since the snowplow was being outfitted, the character display was installed on a Buick LeSabre to allow ongoing development (Figure 5-5). The resulting simulated snowplow was also used to elicit further design suggestions from members of the development team. As in the first mini-study, the windshield was covered to mimic the worst-case whiteout condition. The peripheral view was visible and a team member sat in the passenger seat as a safety precaution.



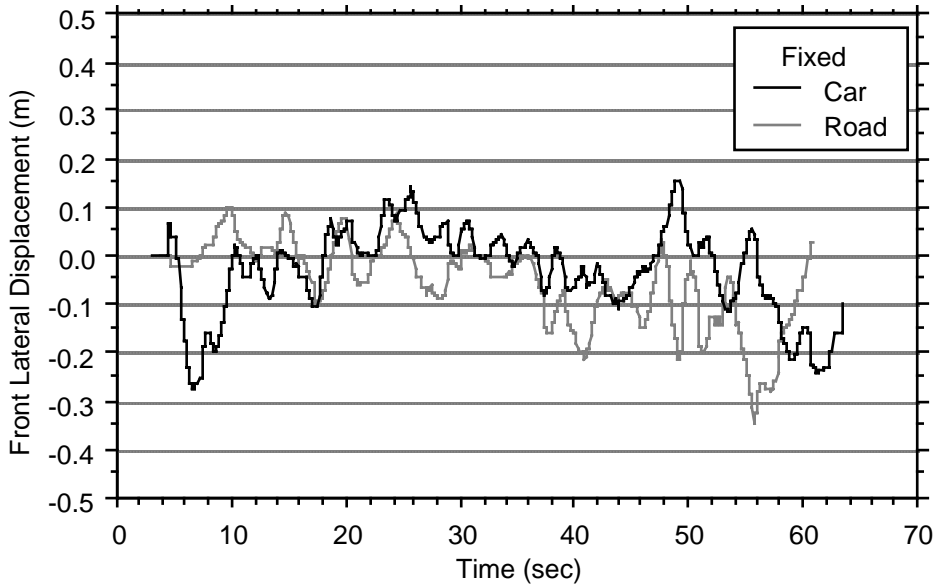
**Figure 5-5: Experimenter Driving from the Character Display with a Simulated Whiteout**

Four members of the development team who had not been exposed to the display acted as subjects for this mini-study. Exposure to the fixed car and fixed road displays was counterbalanced. A trial with a smaller version of the character display was run first for practice. Table 5-1 shows the sequence for each subject.

Subject	Trial Sequence		
	1	2	3
1	Practice	Fixed Road	Fixed Car
2	Practice	Fixed Car	Fixed Road
3	Practice	Fixed Car	Fixed Road
4	Practice	Fixed Road	Fixed Car

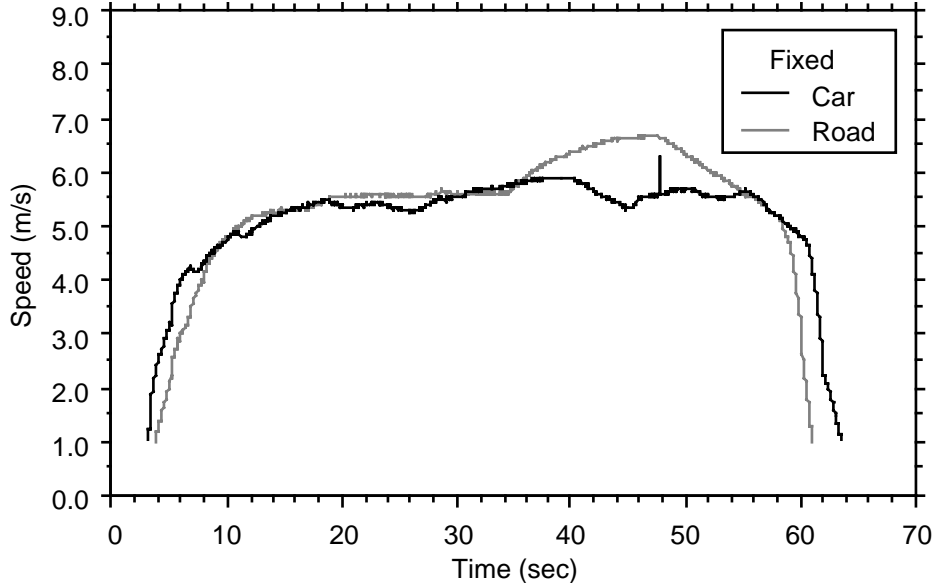
**Table 5-1: Display Sequence for Each Subject**

Figure 5-6 shows that the iconic road display with prediction was quite effective for maintaining lateral position. Note that this driver stayed within a range of a half-meter at the extremes and about 0.3 m for the bulk of the course. Front lateral displacement (FLD) corresponds to the lateral displacement from the center of the lane as measured by the sensors under the front bumper of the car. The car also utilized sensors under the rear bumper, but only the values from the front were used for analysis.



**Figure 5-6: Lateral Performance of Subject 2**

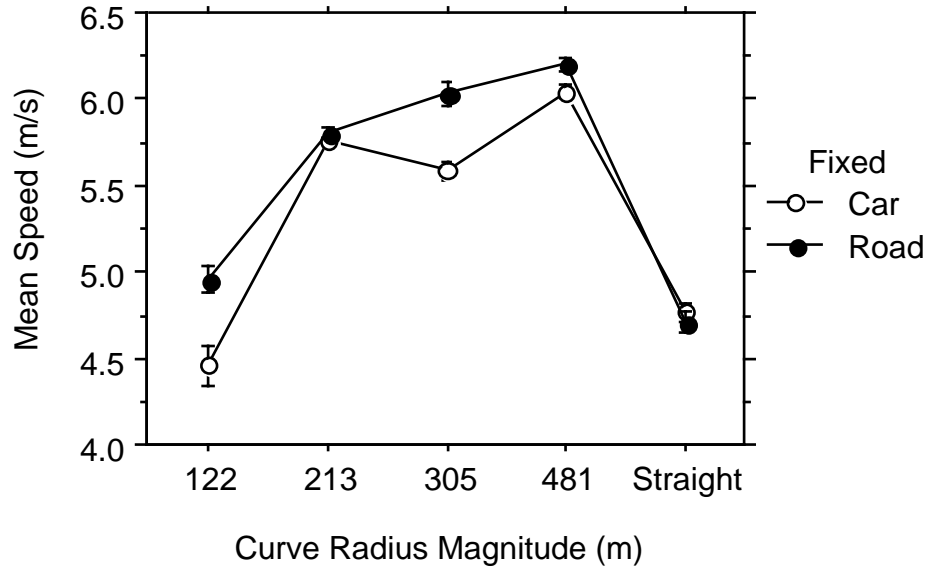
While the speed was fixed for the first mini-study, the drivers were given control in this study (Figure 5-7). The drivers were instructed to maintain a speed between “10 to 15 mph.” Drivers generally reached a speed plateau near the previous study’s 6 m/s (13 mph). Drivers began and ended at a stop (speeds less than 1 m/s were not recorded).



**Figure 5-7: Speed Performance of Subject 2**

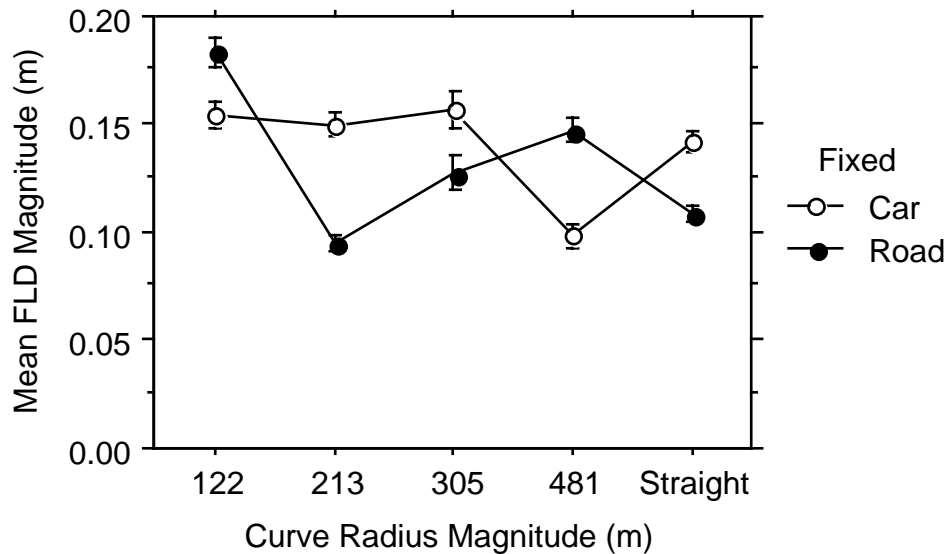
The fixed-road display led to slightly faster speed performance, suggesting the display was easier to use (Figure 5-8). The considerably slower speeds seen for the straight and 122 m radius segments are due to the drivers speeding up and slowing down at the start and end of the track (as seen in Figure 5-7).





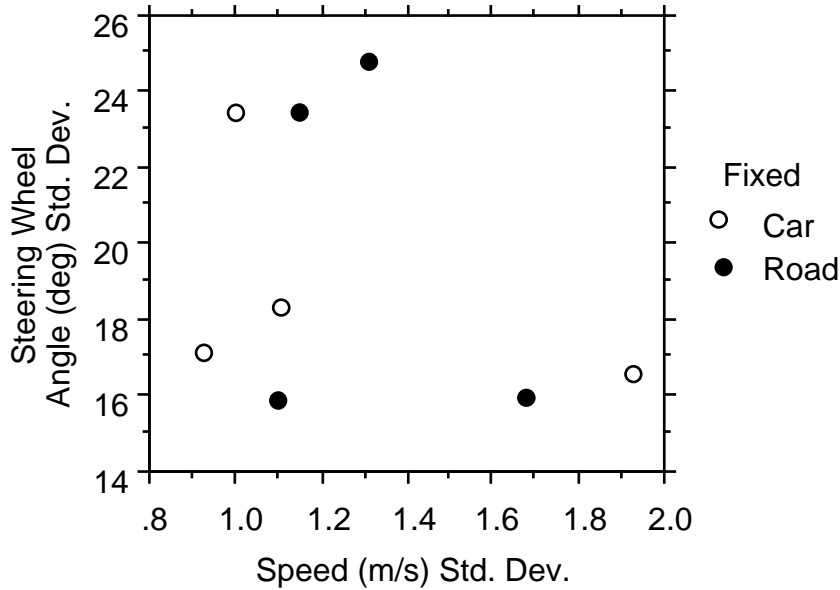
**Figure 5-8: Mean Driver Speed as a Function of Curve Radius and Display Type, with 95% Confidence Intervals**

The lateral performance over each curve radius was somewhat inconclusive (Figure 5-9). In general, the tighter curves seemed to produce slower speeds and more lateral deviation.



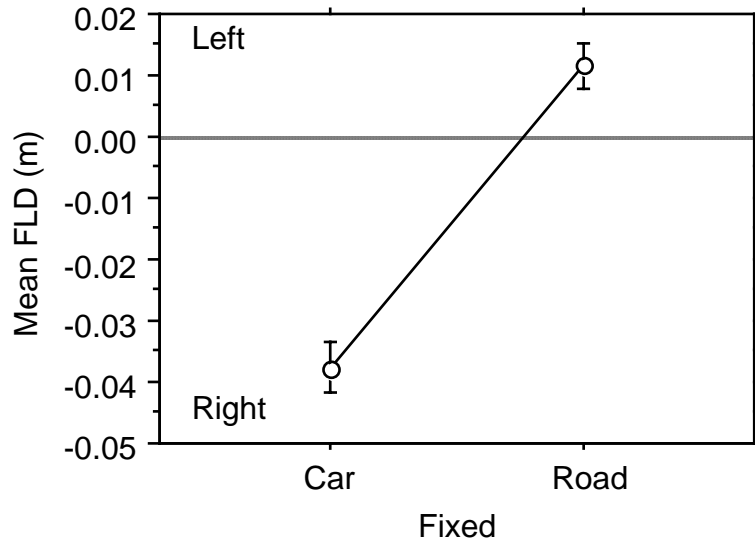
**Figure 5-9: Mean Forward Lateral Displacement Magnitude as a Function of Curve Radius and Display Type, with 95% Confidence Intervals**

The standard deviation behavior data (Figure 5-10) is inconclusive on which part of the display to fix (car or road). Larger steering wheel and speed standard deviations imply that the driving task is more difficult, so that proximity to the origin of Figure 5-10 suggests an easier task.



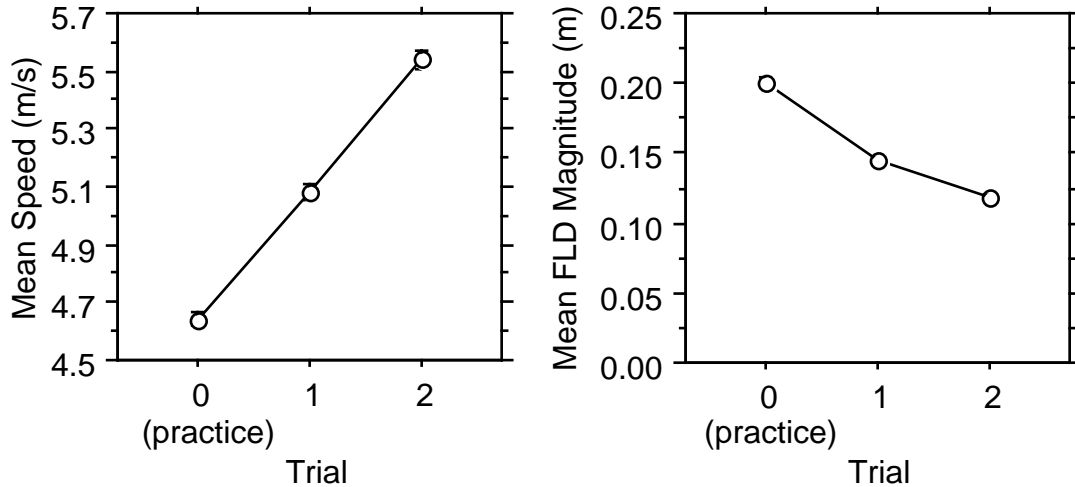
**Figure 5-10: Standard Deviation Data for Second Mini-Study**

One potentially useful finding is that actual lane positioning was worse for the fixed car display (Figure 5-11). All curves on the track, with the exception of the 122 m radius curve, had counterparts that curved in the opposite direction. The curve pairs are within a few meters of each other in arc length. The better lateral position, coupled with the slightly better speed performance over curves results (Figure 5-8), lends credibility to tentatively endorsing a fixed-road display. A firmer endorsement cannot be made due to the predominance of inconclusive findings and the small subject pool.



**Figure 5-11: Mean Lateral Displacement from Lane Centerline, 122 Meter Radius Removed, with 95% Confidence Intervals**

Regardless of the display, a rather promising practice trend was seen for both speed and lane deviation (Figure 5-12). The previously mentioned practice trial was run with a display that was half the size of the others. It was not included in the analysis above. The increase in speed and reduction in lane deviation (especially between trials 1 and 2) suggest that there was a promising learning curve present. This has positive implications for the final display.



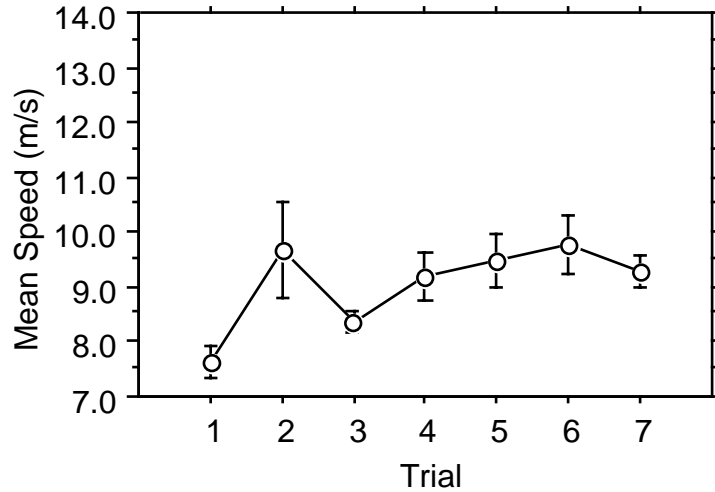
**Figure 5-12: The Impact of Practice, with 95% Confidence Intervals**

The practice effect was also visible in informal observations. During demonstrations of the system to other team members, drivers were asked to drive at 10-15 mph using the fixed-road character display. Drivers typically adapted to the system after two runs. Their FLD magnitude also tended to drop down to levels similar to Trial 2 in Figure 5-12.

### Third Mini-Study: Practice

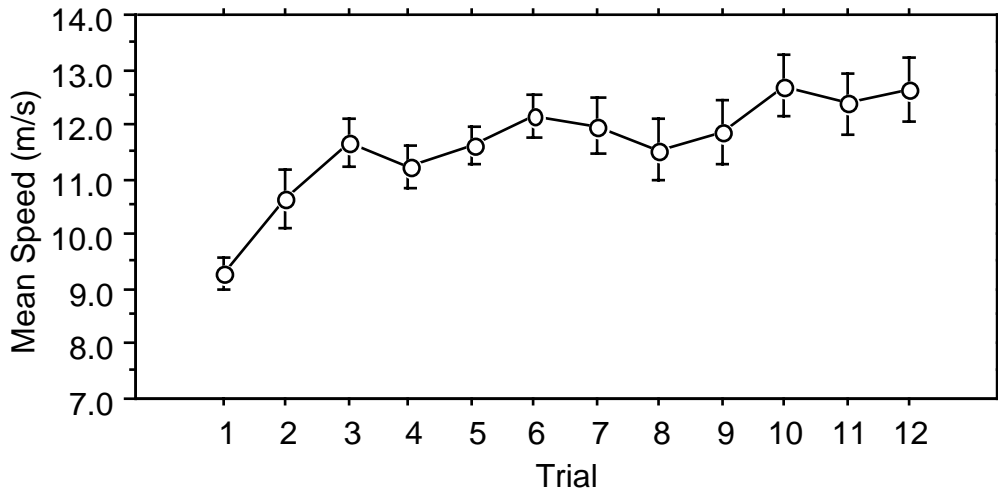
The practice trends observed in the second mini-study led to a pair of small tests. The first examined the effect of practice with long breaks between trials, while the second had much shorter break durations. Since the experimenter (AS) was also the subject for both tests, the windshield cover used in the second mini-study was replaced with a small piece of cardboard. This made observing the magnets difficult but allowed the experimenter to see the road and notice potential hazards. The magnets do not stay in the center of the paved road and there are no lane markings. This modification permitted solo drives and simulated snowpack conditions where lane markings were not visible. The fixed-road display from the second mini-study was used.

The long-break version consisted of seven single trials spaced five hours to one day apart. Speed began to reach a steady level after the 3rd trial (Figure 5-13). The means were computed using the interior portions of the test track (no start-up acceleration or end-trial deceleration). Mean speed was computed across the test track subsections.



**Figure 5-13: Speed Behavior for Long-Break Practice, with 95% Confidence Intervals**

The short-break duration consisted of 12 trials run in sequence, beginning with the last long-break trial. The break between trials was the amount of time necessary to save the data and bring the car back to the start of the track. Speed, steering wheel angle standard deviation, and lateral deviation magnitude began to level at the 3rd trial (Figure 5-14, also interior means). Thus, in both versions, the initial learning period was consumed with approximately 3 trials. Of side interest was that the short-break curve began at the level of the long-break plateau.



**Figure 5-14: Speed Behavior for Short-Break Practice, with 95% Confidence Intervals**

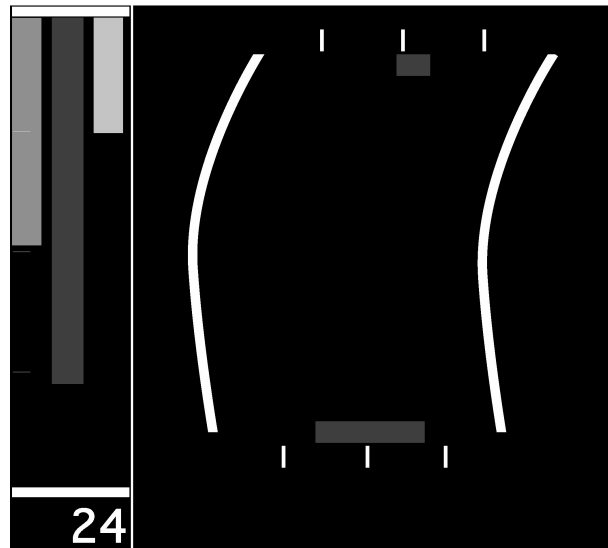
While this data should be treated as preliminary due to the single subject and his familiarity with the display, the results are still quite promising. They reinforce the findings from the second mini-study in showing that drivers adapt quickly to the display.

## Operational System

### **Description of Winter 1998/99 System**

Following character display demonstrations for members of the California Department of Transportation (Caltrans), a more sophisticated and informative display was developed for the plow. This display included collision-warning information derived from a forward-looking millimeter wave (MMW) radar which could track three targets at a time. The initial radar used in the system was not able to detect the lateral angle to the targets. Further detail on the current and future radar systems is provided in Chapter 7.

Figure 5-15 shows an illustration of the display. The left-hand section contained the collision warning information. Downward-moving tapes showed the distance to each of the forward targets. Tapes were chosen because the drivers expressed a desire to know the distance to a potential obstacle. As a result, abstract and single event warning methods (e.g. [4, 21]) were not used. Targets were only shown when they were within 100 m of the plow. The tape changed from yellow, to orange, and then red as the target approached, with color changes at 50 and 25 m. The number at the bottom of the display was the distance to the closest target in meters, since Caltrans is a metric operation. While the radar sensor used in this study does not have the ability to identify the lateral position of the targets, future iterations will place targets in their matching lateral position (left, middle, right).



**Figure 5-15: A Drawing of a Display Scenario**

The lateral display is similar to the character display, but included lane position marks and color-coded system status information. In addition, the prediction capability was extended to 20 m and the displayed logical lane width was 2 m. The center tick marks indicated the center of the lane, while the exterior tick marks indicated 0.6 m (2 ft) offsets, which are used during certain plowing formations. Under normal conditions the lines were white and the current and prediction markers were red. If the computer was uncertain of its current longitudinal position

on the track, but was detecting position markers, the whole lateral display turned yellow and showed a straight road. This signaled to the driver that the display should not be trusted completely. If the plow left the magnets, the color changed to gray and froze. After a short time off the magnets, the lateral display blanked out.

The display was presented to the driver on an LCD panel in the center console area, shown in Figure 5-16. This panel was in-line with the wingplow mirror on the right nose of the hood. The plow blade controls were to the right of the driver immediately behind the floor-mounted gearshift.



**Figure 5-16: Location of the Display in the Cab**

The display location was chosen due to severely limited space and the presence of essential dials and controls on the dashboard. An LCD panel was selected, in part due to time and cost constraints. Two Head-Up Displays (HUD's) were briefly considered but rejected for display specific reasons. The first HUD was a set of special goggles that were rejected due to previous Caltrans exposure to head-mounted equipment. Past experience strongly discouraged such arrangements. The off-head HUD examined was rejected due to cab size constraints. The only usable location was above the steering wheel and near the visor at the top of the windshield. This was viewed as not satisfactory due to the possibility that the driver's head might collide with the unit during a crash or quick deceleration. Projections from behind the driver onto the windshield were not considered due to cost and the lack of space behind the driver's seat; when the seat was all the way back, it touched the rear wall of the cab. In addition, there were safety concerns with having a projection unit mounted near the driver's head, e.g., body motions during side impact crashes.

The team is now searching for a smaller panel display so that other locations can be considered. Field observations of the display also indicated that the "black" on an LCD was not black enough during night conditions, due to backlighting. Thus, the team is also investigating panel displays with true black backgrounds. Future iterations will likely include explorations of other display techniques, e.g. HUDs, auditory assistance, etc. More information on the ASP hardware can be found in Chapter 3.

## **Winter 1998/99 Findings**

During the winter of 1998/99, the ASP was used in two locations. The plow was based at Donner Summit in California for the bulk of the winter. However, there was also a two-week training and evaluation period at US 180 north of Flagstaff, Arizona during March.

### *California operation*

The system was introduced during December 1998 along a portion of Interstate 80 at Donner Summit in the Lake Tahoe area. The test track is at a high elevation (1,950 – 2,190 m, or 6,400 – 7,200 ft) and records large snow accumulations (as much as 16.5 m (54 ft) of snowfall a season with roadside accumulations reaching 6 m (20 ft) high). Whiteouts are common due to blowing wind and the sheer volume of snow. The stretch of road instrumented with magnets is a divided, restricted-access highway with three lanes and wide shoulders traveling uphill and west between the Donner Lake and Castle Peak interchanges, approximately 6.4 km (4 miles). The test route starts about halfway up the northern slope of the Donner Lake valley and ends at the pass summit on the west end of the valley.

Caltrans driver training consisted of a description of display characteristics, a short run over a line of magnets in the maintenance yard, and a longer run on the instrumented test route. The learning period was observed to be very short, as seen with the prototype.

While computer-based driving data has not yet been systematically collected for the Donner Summit installation due to higher priorities for other project activities, the experimenters have had numerous discussions and ride-alongs with the drivers. To date, the drivers have expressed that they like the system and that it enhances their confidence during adverse conditions. They have been generally positive about the implementation.

Observations during ride-alongs indicated that the drivers were able to use the display either for reference or as a primary driving mechanism. It was also apparent that snowplow driving has the potential to be a high mental workload, high stress job. This observation is especially obvious when the driver utilizes the wingplow and sand spreader controls in addition to the standard, forward plow. Other demands arise from gear shifting (the ASP has 13 gears), difficulty with the lights icing, and having to monitor surrounding traffic. As the Lake Tahoe region is a tourist destination for many people not accustomed to driving on snowpack and ice, snowplow drivers often encounter drivers who have skidded off the road or drive in an unsafe manner, even stopping in the middle of the traveled lanes.

### *Arizona demonstration*

The instrumented stretch of US 180 in Arizona consists of a two-lane undivided rural mountain road with frequent whiteouts due to high winds. As this road is not a major Interstate there are areas of tighter curves and steeper grades than seen at the California track. The ASP was in Arizona for two weeks at the end of the 1998/99 winter. As such, there were only a few runs that were completed under snowing conditions; otherwise the pavement and weather were clear.

Seventeen Arizona Department of Transportation (ADOT) snowplow drivers were introduced to the system in a more controlled manner than at Donner Summit due to the much shorter amount of time that the plow was present. Initial training consisted of three team leaders being instructed by people from Caltrans and PATH. The Caltrans trainers rode along with each team leader for one or two circuits along the test route in order to teach the basics of driving the ASP truck. The ASP is quite different from typical ADOT plows in that it has more power, is larger, and has more gears. Following this, a PATH member would replace the Caltrans member and train the driver on the use of the HMI. An initial circuit with only basic instruction was conducted first, followed by a more detailed description of HMI characteristics and additional circuits of practice. The team leaders repeated this training pattern for the rest of the ADOT snowplow operators present at the two-week demonstration. All figures and tables in this section refer to the Arizona testing and operators only.

## **Surveys**

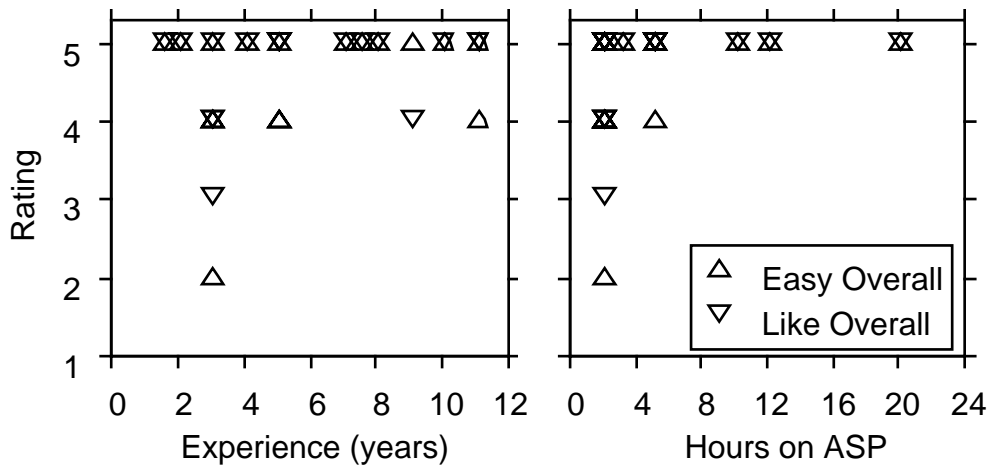
At the end of each training session, the drivers were asked to complete a two-page survey on the ASP HMI, shown in Appendix B, the rating scale was inverted after the data was collected to make analysis and discussion simpler). The results (Survey A, Table 5-2) indicate that the drivers had a high regard for the system. The lane-keeping portion of the display scored slightly higher than the collision-warning system (CWS). This difference is probably due to a lack of trust of the CWS detection performance. The CWS was optimized for the California road configuration (divided interstate), and not adjusted for the significantly different Arizona site, an undivided rural route. The system did not detect objects perfectly; false positives, misses, and warnings that did not readily disappear were not uncommon. In future iterations, a more general CWS capable of better operation in a wide range of road configurations is desired. A second survey was also given to the drivers. This survey included the time spent on the ASP and ratings on a variety of questions. Two of the questions (Survey B, Table 5-2) targeted safety and efficiency. Drivers consistently responded in a positive manner for these questions. Only one driver rated the system below a 7 for the safety question. His comments indicated concern regarding speed and engine rpm maintenance.

A reasonable hypothesis is that snowplow driving experience and exposure to the ASP would lead to higher opinions of the system. Extensive snowplow experience, and thus more on-road exposure, would probably result in having seen or been involved in situations where the ASP would be recognized as useful. Increased exposure to the ASP likely led to greater familiarity, which in turn produced more positive ratings. The three ADOT trainers recorded the most time in the plow. Figure 5-17 illustrates that such patterns existed. These trends are promising in regard to possible deployment of ASP technologies.



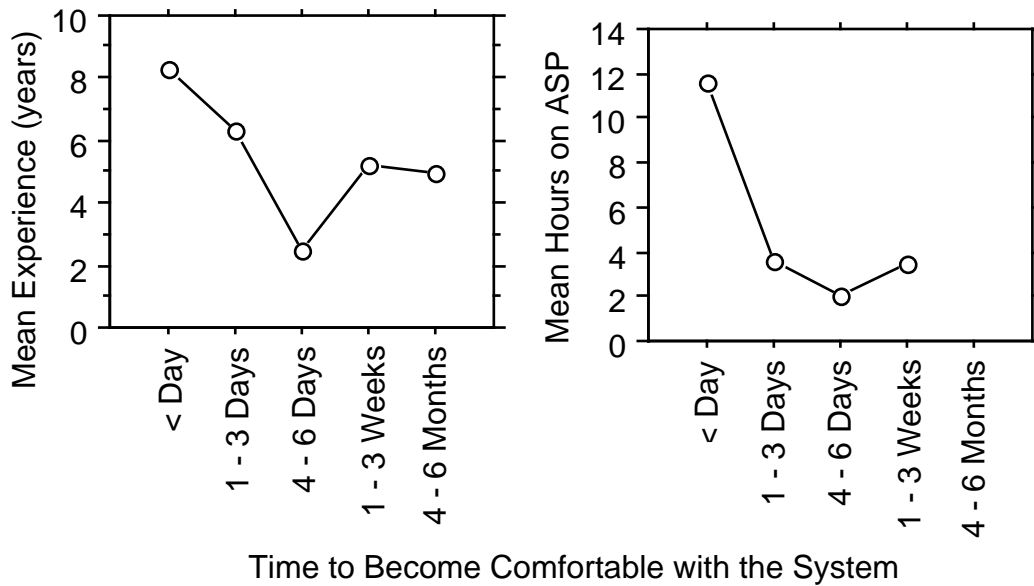
	Mean	Std. Dev.	Std. Error	Count	Min	Max
Experience (years)	5.77	3.17	0.77	17	1.5	11
Time on ASP (hours)	4.88	5.06	1.26	16	2.0	20
Survey A: Ratings (1 - 5, higher being better)						
Overall: Easy to use	4.53	0.80	0.19	17	2	5
Overall: Like	4.71	0.59	0.14	17	3	5
Like More with More Practice	4.63	0.89	0.22	16	2	5
CWS: Easy to use	4.31	0.87	0.22	16	2	5
CWS: Like	4.38	0.96	0.24	16	2	5
Lane Keeping: Easy to use	4.44	0.63	0.16	16	3	5
Lane Keeping: Like	4.69	0.60	0.15	16	3	5
Survey B: "Potential to improve your..." (1 - 10, higher being better)						
Safety	9.18	1.59	0.39	17	4	10
Efficiency	9.12	0.93	0.23	17	8	10

**Table 5-2: Survey Results**



**Figure 5-17: Overall Ratings as a Function of Experience and Exposure, Ratings Are 1 - 5, Higher Being Better**

Snowplow experience and ASP exposure also led to shorter predictions of how much time the driver felt would be needed to become comfortable with the system (Figure 5-18). In general, most drivers felt that they would reach a comfortable state within one month. Only one driver indicated a longer period, 4 - 6 months, and he did not record his mean time in the ASP. He was not a trainer, and thus was probably exposed to the ASP for less than four hours.



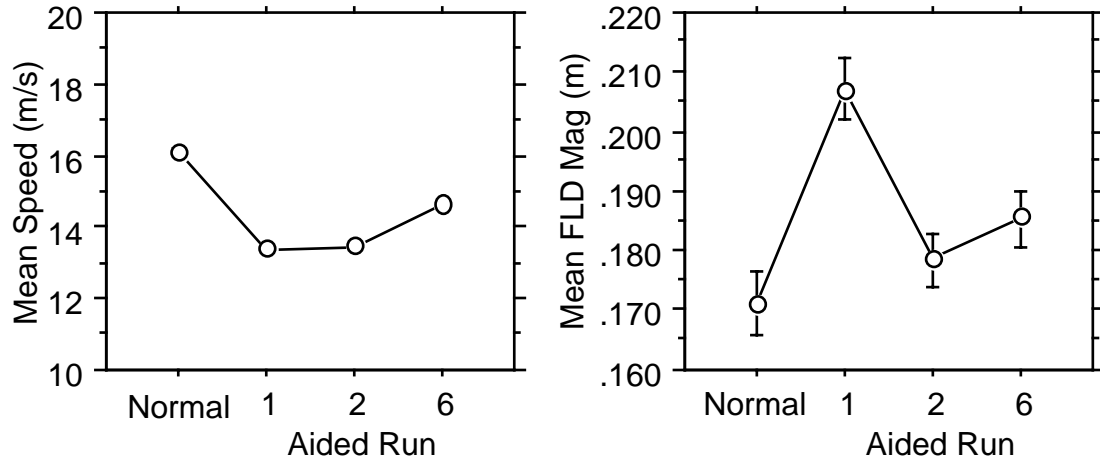
**Figure 5-18: Predicted Time to Reach Comfort with the System**

Driver responses to the open-ended questions on the survey were generally positive. The bulk of the negative comments regarded trust in the CWS, and the desire for a more salient indication of lane departure.

#### Driver behavior data

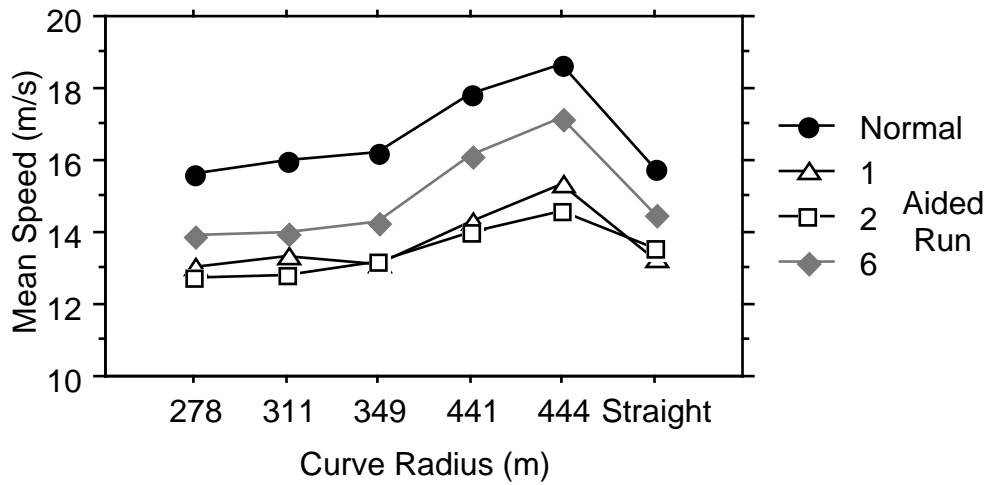
When the plow was brought to Arizona, it was necessary to calibrate the internal map to the new test site. During system testing, data was collected on speed and lane position characteristics at 30 Hz for about 1680 m. Prior to the data collection period, the driver drove along a longer stretch (about 4820 m) under identical conditions. Therefore, the data was collected for the last segment of each run. The data presented here is only for one driver and thus, should be considered preliminary, at best.

The data collection permitted a comparison of normal and HMI-assisted driving. The driver was asked to try to drive with only the HMI during a series of aided runs. Please note that there were clear views, dry roads, and the plow blade was lifted. Normal driving in this case corresponds to ideal conditions. The normal run was collected after several aided runs had been completed. Note that as the driver becomes more familiar with the system, performance approaches normal, unassisted driving (Figure 5-19). ANOVA analyses of Run (Normal, 1, 2, 6) revealed significant differences for both speed ( $F = 4140, p < .0001$ ) and FLD magnitude ( $F = 39.8, p < .0001$ ) as dependent variables.



**Figure 5-19: Driver Behavior Data during System Testing in Arizona, with 95% Confidence Intervals**

There were five curves within the segment examined above. Figure 5-20 further illustrates the increase in driving speed as practice runs accumulated. It is apparent that, with increased experience, the driver approached his speed pattern under normal driving.



**Figure 5-20: Mean Speed as a Function of Curve Radius**

Further analysis across curve radius showed that increased experience led to more consistent lateral positioning. Figure 5-21 shows that the driver had a more stable position in the road. In fact, the tight curves (278 and 311 m) did not seem to affect the driver.

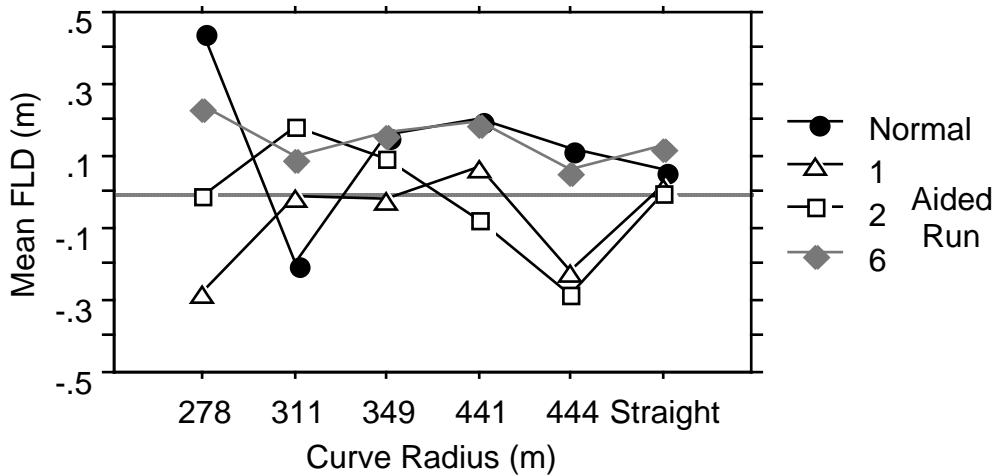


Figure 5-21: Mean FLD as a Function of Curve Radius

As previously mentioned, larger steering wheel standard deviation implies that the driving task is more difficult. Figure 5-22 suggests that the task became easier as the driver's experience increased. Furthermore, the driver seemed to approach the driving difficulty levels of the normal run. This bodes well for low visibility scenarios and implies that it might be possible to reach mental workload levels similar to those of normal driving with good visibility and road surface conditions.

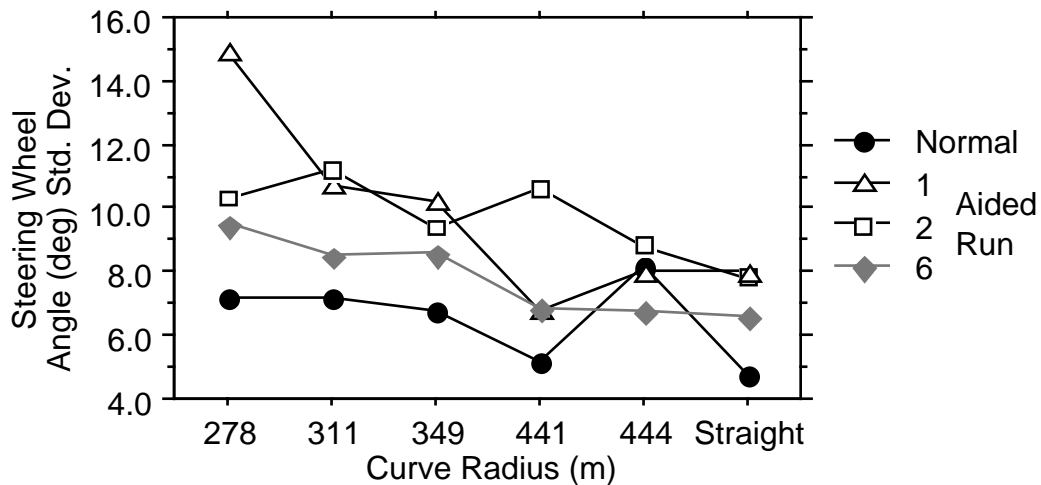


Figure 5-22: Steering Angle Standard Deviation as a Function of Curve Radius

The decrease in driving difficulty is reinforced by the clustering of the normal and 6th aided run near the origin in Figure 5-23. As previously mentioned, reduced levels of standard deviation for both steering wheel angle and speed are typically associated with easier driving. The four points to the right (Speed SD > 1.0 m/s) correspond to the data derived from the straight portions of the track. The higher speed standard deviations are probably due to accelerations and decelerations before and after curves.

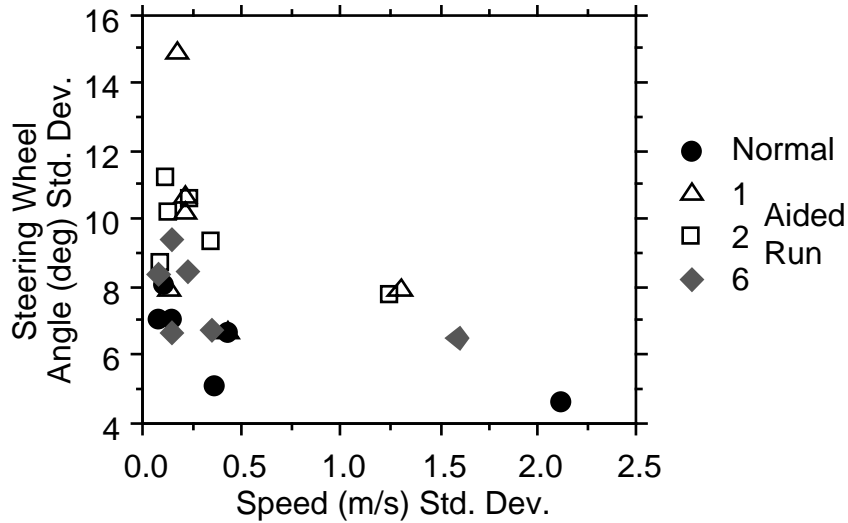


Figure 5-23: Standard Deviation Data

HMI Conclusions

From the initial work conducted during this project, it is clear that the ASP system has the potential to be quite beneficial to driver safety and confidence. The ability to traverse low-visibility areas at faster rates of speed should also lead to improved efficiency during snow removal operations.

The findings from the lateral-assistance portion of the HMI suggest that, with proper instruction, the interface is intuitive and easy to learn. Most drivers were observed to reach a stable level of performance using both the prototype and the ASP after only three trials. Anecdotal comments and experimenter observations also suggest that the HMI can be easily used for either reference or as a primary driving guidance mechanism.

In general, driver comments were regularly positive and optimistic that the system would benefit their safety and efficiency. The drivers' fast acquisition of the system bodes well for future iterations and eventual deployment. Their suggestions for HMI improvements have been very helpful and will be combined with the objective findings to improve upon the system. Subsequent iterations will include continuous improvements to the HMI.



## CHAPTER SIX

### MAGNETIC SENSING SYSTEM

#### Introduction

The development of a reliable and accurate lateral referencing system is crucial to the success of the lateral guidance system of the snowplow. PATH has proposed and developed the use of magnetic markers embedded in the road center to provide lateral position and road geometric information [22]. This setup enables the lateral guidance system to provide the snowplow driver with two fundamental pieces of information that support steering control: the vehicle location with respect to the roadway, and the current and future road geometry. Furthermore, the lateral referencing system provides sufficient accuracy and resolution to enable the calculation of other vital information for the stability of human steering control [16].

Extensive development and experimentation have been performed on magnetic marker-based lateral sensing systems for many PATH vehicles equipped with automated steering control [17]. The vast knowledge available about this lateral sensing technique was one of the primary reasons that this technology was chosen to support the steering guidance system. Other positive characteristics of this lateral sensing technique include good accuracy (better than one centimeter), high reliability, insensitivity to weather conditions, and support for binary coding. The requirement of modifying the infrastructure (installing magnets) and the inherited “look-down” nature (the sensor measures lateral displacement at location within vehicle physical boundaries, versus look-ahead ability) of the sensing system [7] are two noticeable limitations of this technology. Although the associated application software for this sensing system can be quite involved, the principle is straightforward. Magnetic markers are installed under the roadway delineating the center of each lane. Magnetometers mounted under the vehicle sense the strength of the magnetic field as the vehicle passes over each magnet. Onboard signal processing software calculates the relative displacement from the vehicle to the magnet based on the magnetic strength and the knowledge of the magnetic characteristics of the marker. This computation is insensitive to vehicle bouncing (e.g., heave and pitch) and the ever-present natural and man-made magnetic noises. Furthermore, roadway geometric information can be encoded as a sequence of bits, with each bit corresponding to a magnet [6]. The polarity of each magnet represents either 1 or 0 in the code. In addition to the lateral displacement measurement and road geometry preview information, other vehicle measurements such as yaw rate, lateral acceleration, and steering wheel angle may be used to improve the performance of such a lateral guidance system [5, 16].

This chapter describes the background information on both the magnetic marker concept and the development of a reliable magnetometer sensor signal processing algorithm.

#### Magnetic Marker Model

A representative mathematical model of the magnetic marker provides a base for understanding of many important issues regarding the design of a reliable signal processing algorithm. Among these issues, the key problems that determine the effectiveness of any

algorithm are how to reliably detect the magnets, how to remove the effect from vehicle bounces, and how to desensitize the noise disturbance effects. Particularly the researchers from PATH have chosen to model the markers as magnetic dipoles for analysis purposes. Aside from its relative simplicity and compactness, extensive testing at the Richmond Field Station reveals a strong correlation between model prediction and empirical measurements [12, 22].

Under the dipole assumption, the magnetic field,  $B(x, y, z)$ , at some location,  $P(x, y, z)$ , can be given by

$$B = \frac{\mu_0 M}{4\pi r^5} (3xz i + 3yz j + (2z^2 - x^2 - y^2) k) \quad (6-1)$$

where  $r = \sqrt{x^2 + y^2 + z^2}$ ,  $\mu_0$  is the permeability of the open space, and  $M$  is the magnetic moment of the magnetic marker. Note that the coordinate system ( $P = xi + yj + zk$ ) is chosen so that  $xi$  corresponds to the direction of vehicle travel,  $yj$  the lateral deviation, and  $zk$  the height, relative to the marker's center.

From Equation (6-1), it is clear that at any given longitudinal location  $x$ , in particular at  $x=0$ , there exists a one-to-one and onto mapping from the magnetic field  $B(0, y, z)$  to the sensor location  $(0, y, z)$ . Therefore it is theoretically plausible to invert this mapping to obtain the lateral deviation as well as the sensor height at the sensor location just as the vehicle passes over each magnet ( $x=0$ ). The method of inverting this mapping is not unique. It can be analytical, numerical, or experimental. One crucial determination factor of designing a real-time algorithm of the inverse mapping is the tradeoff between the algorithm's effectiveness of handling noise and the algorithm's complexity.

### Noise Effects

Four major noise sources are usually present in the magnetic signal measurements in a typical vehicle operational environment. They are: Earth field, local magnetic field distortion, vehicle internal electromagnetic field, and electrical noise.

The most frequent external disturbance is the Earth's ever-present permanent magnetic field, which is usually in the order of half a Gauss. The value of the Earth field measured by the magnetometers on the vehicle depends on the location of the vehicle on Earth as well as the attitude and orientation of the vehicle. Although the Earth magnetic field usually changes slowly, sharp turns and severe braking can quickly change the value of measurements along the vehicle axes.

The most serious noise problems are caused by local anomalies due to the presence of structural supports, reinforcing bars (rebars), and the ferrous components in the vehicle. Power lines under ground represent another source of such local field distortion. Rebar or structural support usually creates a sharp change in the background magnetic field and sometimes is difficult to identify. Most signal processing algorithms would have some limitations to recover from such sharp distortions. The ferrous components in the vehicle, on the other hand, can be isolated as long as their locations are fixed with respect to the magnetometers.



A third source of noise comes from the alternating electric fields generated by various motors operating in the vehicle. These motors may include alternator, fan, electric pump, compressor and other actuators. However, their effects vary according to the motor rotational speeds and its distance to the magnetometers. The higher the motor rpm or the farther it is placed away from the magnetometers, the less the effect of the resultant noise is. Sometimes modest changes in sensor placement can alter the size of such disturbances.

The last common noise source arises from the electrical noise in the measurement signal itself. Such noise can be created by the voltage fluctuations in the electrical grounding or from the power source. It can also be a result of poor wiring insulation against electromagnetic disturbances. Usually, the longer the wire, the higher such noise is. Although a low pass filter sometimes reduces the magnitude of such disturbance, noticeable degradation of the magnetic sensor signal process algorithm occurs when such noise level exceeds 0.04 Gauss.

### Magnetic Sensing Algorithm

One of the important attributes of the lateral sensing system is its reliability. Currently, there exist several algorithms designed to detect the relative position between the marker and sensor (magnetometer), as well as to read the code embedded within a sequence of these markers. Three magnetic marker detection and mapping algorithms have been experimented with by PATH [12, 22]. The first is called the “peak-mapping” method that utilizes a single magnetometer to estimate the marker’s relative lateral position when the sensor is passing over the magnet. The second algorithm is the “vector ratio” method and it requires a pair of magnetometers to sample the field at two locations. It returns a sequence of lateral estimates in a neighborhood surrounding, but not including the peak. The third is the “differential peak-mapping” algorithm that compares the magnetic field measurements at two observation points to eliminate the common-mode contributions and reconstructs a functional relationship between the differential sensor readings and the lateral position using the knowledge of the sensor geometry. The “peak-mapping” algorithm was selected for the snowplow project because it has been proven effective over a wide range of speeds and has been widespread applied in many experiments conducted at PATH.

Under the assumption that the vehicle lateral speed is significantly smaller than that of the vehicle longitudinal velocity, it is obvious that the largest vertical field  $B_z$  occurs at the point when the sensor is just passing over the magnetic marker, i.e. as  $x=0$ . This point is called “peak” because it corresponding to the point where the magnetic field achieves its maximum during its trajectory around the magnetic marker in question. The most important fact is that the three-dimensional mapping as in Equation (6-1) can be reduced to a two-dimensional mapping using the constraint relationship  $x=0$ .

Two basic methods can be used to detect the peaks: the variance method (using  $B_z$ ) and the switching (using  $B_x$ ) method. The variance method computes the instantaneous variance of the vertical field  $\sigma_z(t_k)$  as

$$\sigma_z(t_k) = \frac{1}{k} \sum_{i=k-N}^k (B_z(t_i) - \bar{B}_z(t_k))^2 \quad (6-2)$$

where  $\bar{B}(t_k)$  is the running average of the last  $N$  samples, i.e.,

$$\bar{B}_z(t_k) = \frac{1}{N} \sum_{i=k-N}^k B_z(t_i). \quad (6-3)$$

Using this variance, the peak and the valley of the vertical field can be identified using the following relationship

$$\text{if } |B_z(t_k) - \hat{B}_{zEarth}| > HIGH\_threshold \quad \& \quad \sigma_z(t_k) < \varepsilon \Rightarrow \text{Peak detected}, \quad (6-4)$$

$$\text{if } |B_z(t_k) - \hat{B}_{zEarth}| < LOW\_threshold \quad \& \quad \sigma_z(t_k) < \varepsilon \Rightarrow \text{Valley detected}. \quad (6-5)$$

Equation (6-5) suggests that if the marker is sufficiently far from the sensor, then the field from the magnetic marker is negligible. Thus the Earth field estimate ( $B_{zEarth}, B_{yEarth}$ ), vertical and horizontal Earth fields, can be updated based on the sensor measurements at the valley. It should be noted that the Earth estimates play a very important role in the accurate computation of the lateral deviation.

To improve the reliability of the peak detection process, the switching method utilizes the sign-change property of the longitudinal field ( $B_x$ ) at peak both to provide candidates for peaks and to double-check any detected peak.

Once the peak is detected, the marker's magnetic field is computed as

$$B_{zMagnet} = B_z(t_m) - \hat{B}_{zEarth}, \quad \text{and} \quad B_{yMagnet} = B_y(t_m) - \hat{B}_{yEarth}. \quad (6-6)$$

By setting  $x=0$  on Equation (6-1), the slope function between the vertical and horizontal field of  $B_{Marker}$  can be expressed as

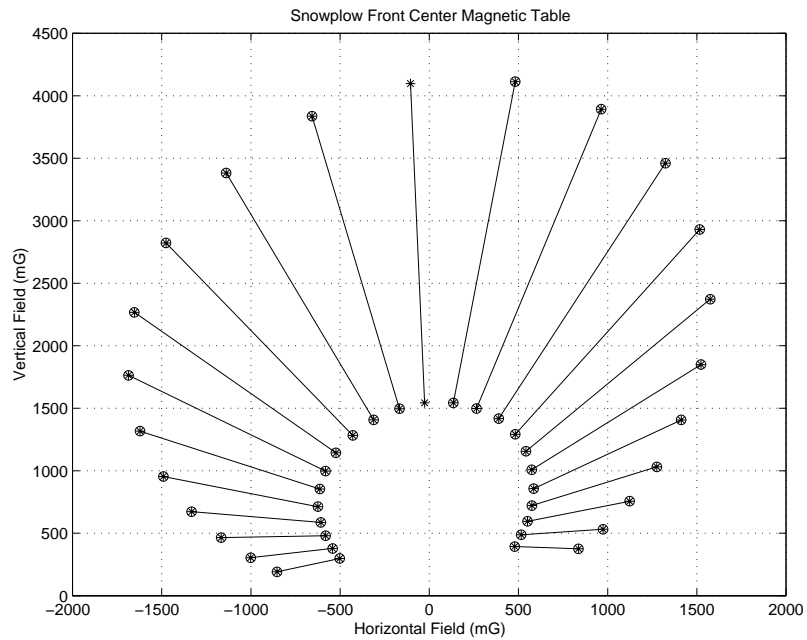
$$\frac{B_{zMagnet}}{B_{yMagnet}} = \frac{2z^2 - y^2}{3yz} \equiv \varphi(y, z). \quad (6-7)$$

It is known from the calculus that the curve ( $B_z, B_y$ ) forms a field if  $\varphi(y, z)$  is single-valued, or that partial derivatives of  $\varphi(y, z)$  do not vanish. Since

$$\frac{\partial^2 \varphi(y, z)}{\partial y \partial z} = \frac{y^2 - 2z^2}{3y^2 z^2} \neq 0, \quad \text{as long as } y \neq \sqrt{2}z, \quad (6.8)$$

under the restriction that  $y \in \{y_{\min}, y_{\max}\}$  and  $z \in \{z_{\min}, z_{\max}\}$ , with  $z_{\min} > 0$  and  $y_{\max} < \sqrt{2}z_{\min}$ , the curve  $\{B_{yMarker}, B_{zMarker}\}$  does form a field. Therefore, the inverse mapping from  $\{B_{yMarker}, B_{zMarker}\}$  to  $\{y, z\}$  does exist for most of our application where  $z_{\min}$  is usually greater than 15 cm and  $y_{\max}$  is less than 20 cm. Thus, it is possible to determine lateral offset and vehicle height from field measurements.

In the snowplow environment, the magnetic field maps deviate quite significantly from the theoretical prediction from Equation (6-1), due to the massive amount of ferrous material from the plow's structural support located in the vicinity of the magnetometers. A numerical mapping created by empirical data gathering, i.e. calibration, is used to create the associated inverse maps. A typical inverse map is shown in Figure 6-1 where two sets of calibration data, one at 9 centimeter height (outer points) and the other at 11 centimeter (inner points), for the vertical and horizontal field of the marker are collected at the interval of every 2 centimeter lateral displacement. One advantage of this method is its robustness against height variations. Observe from Figure 6-1 that changes in  $z$  only serve to move the coordinates along the radial lines that denote constant  $y$ , i.e. constant lateral offset.

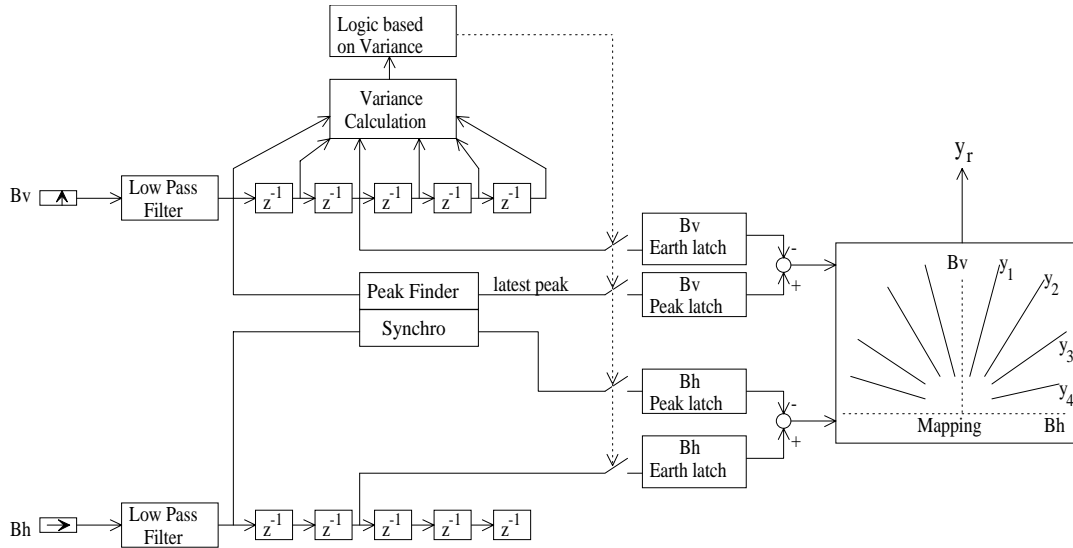


**Figure 6-1: Snowplow Front-Center Magnetic Table**

### Signal Processing Algorithm

The magnetometer signal processing for the “peak-mapping” method involves the following three procedures: peak detection, Earth field removal and lateral displacement table look-up. Figure 6-2 provides a block diagram of the algorithm. Although it is straightforward in principle, it becomes complicated when the reliability of the process is the major concern. There are many parameters in the lateral sensing signal processing software which need to be tuned in order to provide consistent lateral displacement information regardless of vehicle speed, orientation, operating lateral offset and vehicle body motion. Debugging can become very time consuming when the failure condition cannot be recreated. To improve the reliability of the lateral sensing system with the magnetic road markers, PATH has developed a “reconstructive” software system for the lateral sensing signal processing. When specified as a “reconstructive run”, the real-time software in the vehicle, besides processing data as usual, stores all sensor data in the memory and later dumps it into a data file. Identical signal processing software as the one run in the real-time environment can later be generated in a desktop computer, using the data stored during vehicle

testing as inputs with the same QNX operating system. In such a setup, any erroneous situation can be recreated in a lab environment and debugged with ease. With this new development environment, the developers can (1) capture the problematic performance as soon as it happens, (2) recreate the situation step-by-step in the lab environment, and (3) modify the software as well as validate the changes before upgrading the new version of software in the test vehicle.



**Figure 6-2: “Peak-Mapping” Magnetometer Signal Processing Block Diagram**

## CHAPTER SEVEN

### COLLISION WARNING SYSTEM

Highway snow removal is a hazardous operation. Poor road traction and reduced visibility often lead to collisions with other vehicles and roadside objects. The costs, both human and financial, of such a collision can be substantial. One approach to reducing these costs is to implement a system that provides a virtual buffer zone around the vehicle using visual or auditory warning of an impending collision.

Such a system must be able to detect approaching vehicles and determine which ones pose a threat. Also, the system should be capable of detecting fixed hazards on the road, including stalled cars and highway infrastructure. However, to be useable, such a system must minimize false alerts; otherwise, the system will soon be ignored.

Severe environmental conditions are encountered in mountainous snowplow operations, including blowing snow, spraying salt, and extreme vibrations. Clearly, the collision avoidance system must be capable of surviving and functioning properly in such an environment.

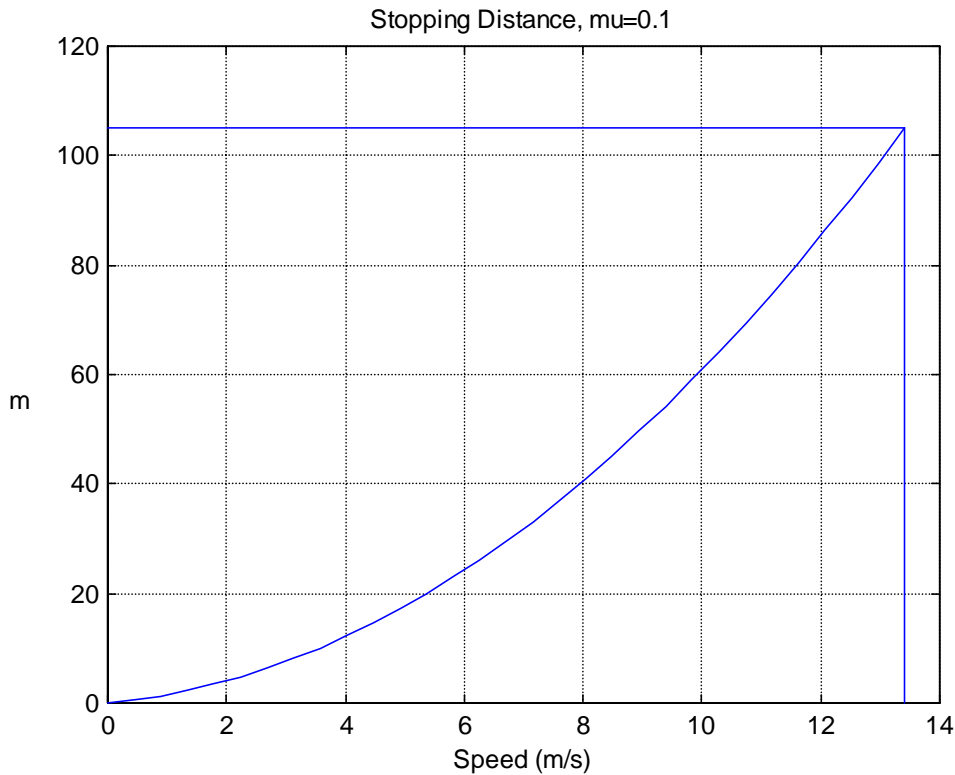
#### Sensing Requirements

In California, snowplows operate at speeds up to 13.4 m/s (30 mph). Assuming a worst-case tire-to-road friction coefficient of 0.1, corresponding to rubber on glare ice [20], the maximum plow deceleration is 0.1 g. With this deceleration, and assuming a one second delay between any warning provided by the HMI and actual braking action by the operator, the stopping distance versus vehicle speed is shown in Figure 7-1. For the maximum plowing speed, the total distance traveled with this worst-case deceleration is 105 m (344 ft). Ideally, the ranging sensor should provide at least this sensing range. Commercially available sensors typically have a 100 m range, which is deemed adequate. In addition, to avoid creating false alarms, the sensor should not detect objects that are not potential obstacles. Further, because plowing operations often take place in mixed traffic, a warning that reports only on distance to the nearest object is inadequate. Such a system is incapable of discriminating between an approaching car, a stalled car or other object and a car moving in the same direction as the plow with similar speed, all of which could be the same distance away and pose quite different risks. Thus, rate information is needed in addition to range. To reduce false alarms from highway infrastructure and to provide enhanced collision warning when cornering, a radar unit that provides data on the lateral position (azimuth angle) of objects as well as their range and closing rate is also desirable. Such a radar was not used in the current work, but will be used in the Phase II research work.

#### Sensing Technologies

Several basic sensing technologies have been developed. These include radar, vision, and acoustic systems. Vision systems, either employing lasers or advanced image processing are very sensitive to weather and considered unsuitable for a snowy environment. No acoustic system evaluated was capable of both providing the needed rate information about approaching objects and operating in the highly vibratory environment of a heavy vehicle. Only radar systems were found to be sufficiently advanced in development and robust enough for this

application. All the radar systems considered for use in the ASP operated at approximately 24 GHz, corresponding to a wavelength of about 1.25 cm, and could resolve targets that were approximately 1 m<sup>2</sup> or larger.



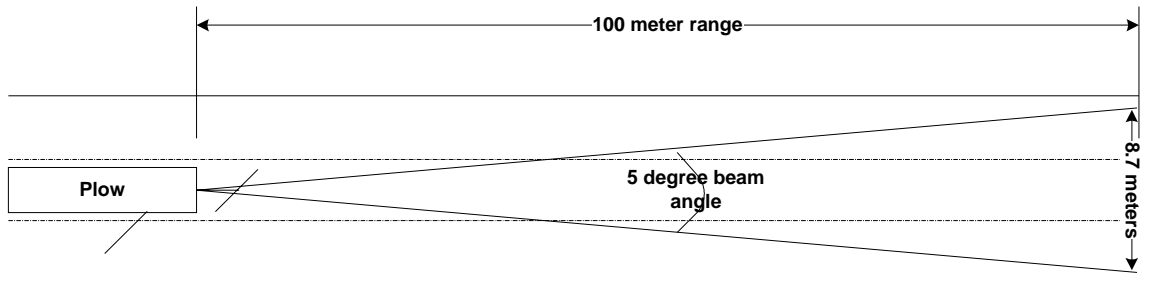
**Figure 7-1: Plow Stopping Distance for 0.1 g Deceleration and 1.0 Second Reaction Time**

### System Selection

Four options were considered for the ASP radar unit: A custom unit from O’Conner Engineering; a standard unit from O’Conner engineering; a commercial vehicle radar system from Eaton-Vorad; and a commercial vehicle radar system from Delco Electronics. The last three systems were very similar. Each has a range of 100 m (328 ft) and a fairly narrow beam width. Each also provides range and rate information. Of these three systems, the Delco system was rejected due to insufficient product information to allow system evaluation and integration. The O’Conner system was both less ruggedized and more expensive than the Eaton-Vorad system. In addition, the Eaton-Vorad system, which is currently used on heavy trucks, was able to track three targets instead of the one tracked by the O’Conner system. This ability later proved necessary under certain conditions. It also provided an easy upward migration path from the current system to one that provides complete two-dimensional information about the targets ahead. The custom system from O’Conner Engineering would also have provided complete two-dimensional information about oncoming vehicles; however, it proved prohibitively expensive. Finally, the demonstrated success of the Eaton-Vorad unit in the CVO industry indicated that the system was field-ready.

### Capabilities

The unit selected, the Eaton-Vorad EVT-200 has a maximum range of 100 m (328 ft) and a 5-degree field-of-view. The sensing geometry of the EVT-200 is shown in Figure 7-2. This is adequate to detect vehicles in the plow's lane. Note that the horizontal scale is compressed by about a factor of two.



**Figure 7-2: Diagram of Area Covered by EVT-200 Collision Warning System**

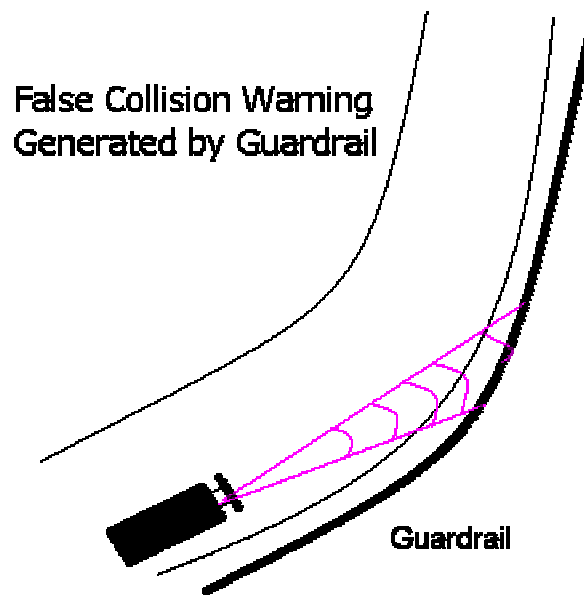
For CVO applications, the EVT-200 mounts on the bumper of heavy trucks. Because of obstruction by the plow blade, this mounting location is unavailable. In order to sense objects ahead of the plow, the radar was mounted on the vehicle grill. This grill mounting renders the truck incapable of detecting a small car within 10 m (33 ft) of the vehicle. In operation it was found that this radar gap did not significantly affect CWS performance.

### False Warning Suppression

To reduce the possibility of a false alarm the system algorithms were developed to prevent a false alarm in a situation like the one shown in Figure 7-3. These algorithms have not been implemented as part of the current research. However, they are documented here for future reference, as they may be applicable in Phase II research. The use of these algorithms will be evaluated in light of the expectations and needs of the operators, as well as the capabilities of any revised sensor installation.

The envisioned system would work by first throwing out targets that are not on the road. This is done by looking up the curvature of the road ahead in either a stored table or by obtaining it from magnetic coding. This curvature information is then used to determine the point where the radar beam leaves the road. Non-moving targets that are farther away than this distance are excluded. Further, from position information stored in the database other false warnings could also be suppressed, e.g. signs and other infrastructure. Development on this system was halted when it was determined to be unnecessary for adequate performance on the California test route. However, the capability would have been very useful in the Arizona testing environment, and is clearly desirable for any future radar system. As noted elsewhere, Eaton Vorad includes a similar feature in the next revision of the hardware, the EVT-300, which relies on a yaw rate sensor to determine roughly the same information. However, if magnet coding is available, the yaw rate approach is inferior because a false alarm can be generated before the vehicle starts

turning and because it is unable to suppress alarms caused by detecting bridges over a hill or changes in slope.



**Figure 7-3: Diagram of Situation Capable of Generating a False Collision Warning**

#### Vehicle and Computer Interface

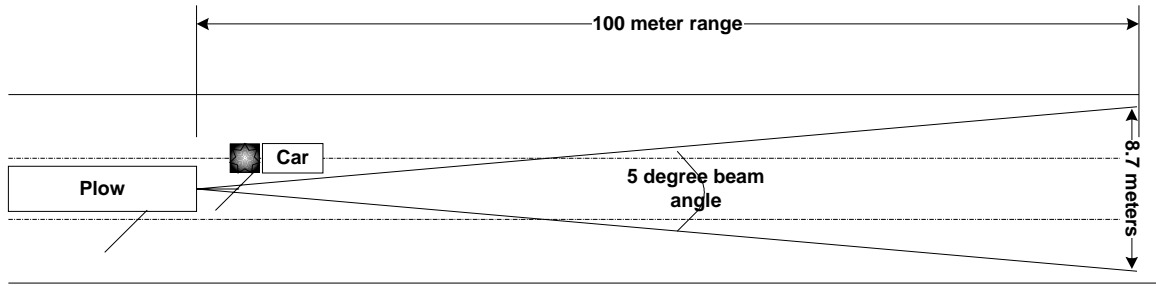
The EVT-200 interfaces to the vehicle in two ways. It connects to the vehicle's SAE J1587 data bus to extract data on vehicle speed and other parameters. This interface also allows the radar to be tested and reconfigured through the vehicle diagnostic port with the appropriate diagnostic tool, known as a "J-Tool". It also senses brake position through a tap into the vehicle wiring before the brake light so that it can sense whether the vehicle is braking.

The computer interfaces to the EVT-200 via an RS-232 serial connection. Over this connection, several pieces of information are transmitted, including the approach rate of the three most significant targets, the distance of these three objects from the plow, and target ID information to distinguish between targets. The computer processes the information and displays an appropriate warning on the vehicle display. The processing is described in Chapter 4, while details of the radar display are provided in the HMI description in Chapter 5. The serial interface is documented in reference material from Eaton Vorad.

#### Suggested Future Capabilities

A radar system capable of detecting vehicles in two dimensions, instead of just providing longitudinal information is desirable to suppress false alarms and to allow a wider beam, enabling the radar system to provide an alert for collisions in a clipping mode, as illustrated in Figure 7-4. As in Figure 7-2, the horizontal scale is compressed by about a factor of two. Such a system, by providing azimuth to target, also allows advanced CWS display options for the HMI.





**Figure 7-4: Collision Caused by a Drifting Vehicle, a.k.a. “Clipping”**

Also desired is a second forward looking radar unit that is capable of detecting objects that are in danger of colliding with the wing plow. AHMCT researchers are currently evaluating this configuration as part of Phase II developments.



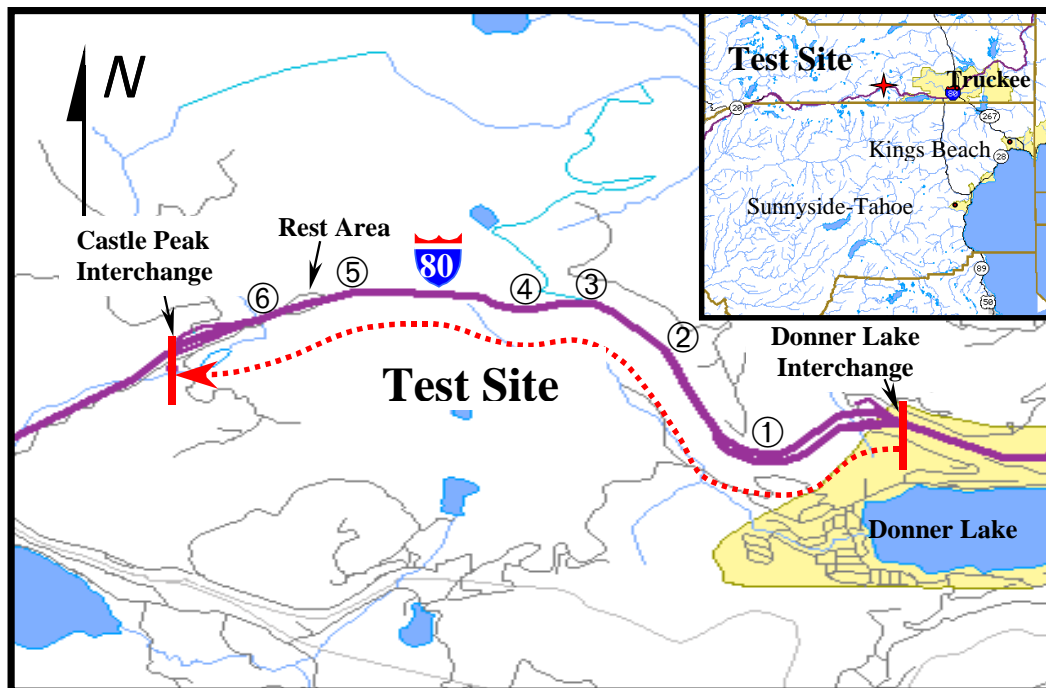
## CHAPTER EIGHT

### TEST RESULTS AND EVALUATION

#### Introduction

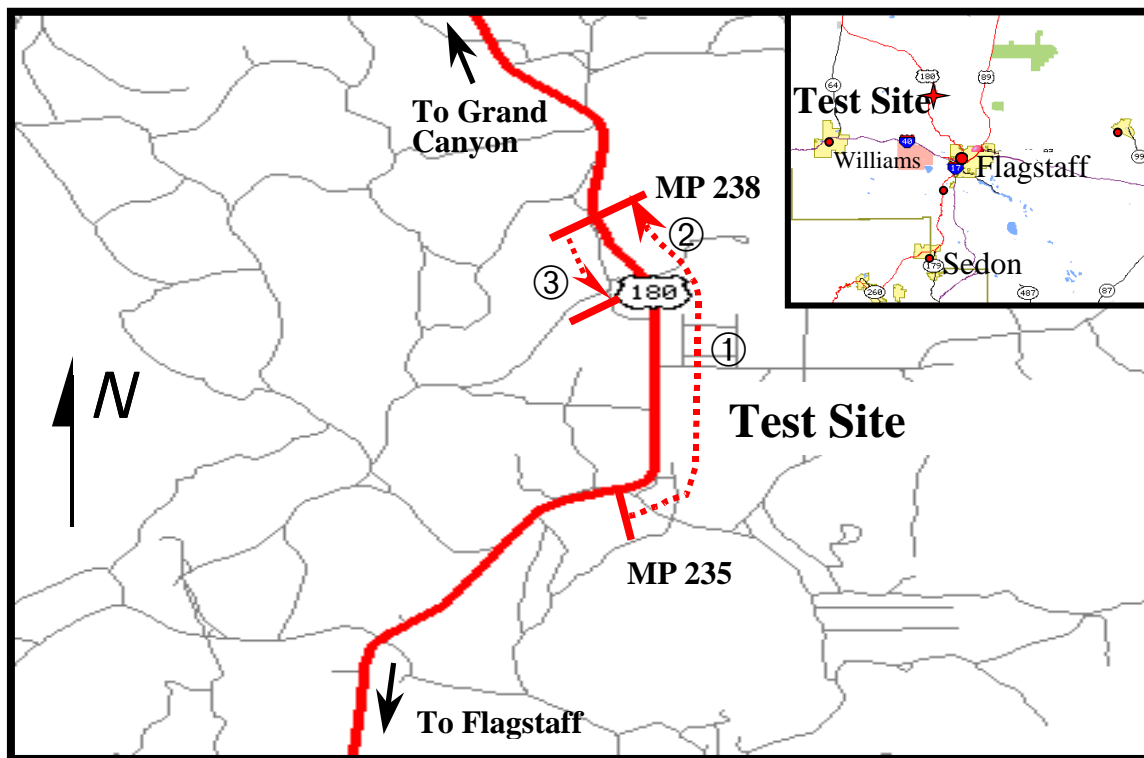
Major travel routes that are dangerous due to large amounts of snowfall are potential areas where advanced technologies like these may be utilized. This study considered two such areas: Interstate 80 over Donner Pass in California, and Highway US 180 through Kendrick Park, north of Flagstaff, Arizona. The two sites major shared features include easy access and potential for heavy snow and whiteout conditions.

California's instrumented test-site encompasses approximately 6.3 km (3.9 miles) of the westbound lane of Interstate 80 in Nevada County near Donner Pass (Figure 8-1). This site runs from the Donner Lake Interchange milepost (MP) Nev-9.1 to Donner summit MP Nev-5.1 reaching an elevation of 2206 m (7239 ft). The entire site is located in mountainous terrain, with steep grades and many curves. The designated location was chosen because this portion of I-80 typically closes before other sections of the road due to weather patterns and has a relatively high vehicle per hour traffic count. This stretch of divided interstate contains both two and three lanes of travel in each direction, with a shoulder on the right. For the sake of evaluation, the test site was divided into six segments, due to differences in elevation, weather, etc., as shown on the map in Figure 8-1.



**Figure 8-1: Demonstration Site over Donner Pass, California**

The site chosen in Arizona represents a total of approximately 6.4 km (4 miles) within Kendrick Park on US 180, which is located about 32 km (20 miles) northwest of Flagstaff, Arizona (Figure 8-2). This instrumented test-site is situated at roughly 2440 m (8000 ft) in elevation and runs northward from MP 235.0 to MP 238.0 and southward from MP 238.0 to MP 237.0. The northbound three-mile segment begins in forest, continues through an open, windswept valley and ends with a winding eight percent downgrade. The southbound one-mile segment returns back through the winding uphill grade. This location receives frequent snowfall and is often exposed to winds of varying force, resulting in whiteout conditions and drifting. The designated road segment is in a relatively high traffic area because it is the shortest route from Flagstaff to Grand Canyon National Park. For the sake of evaluation, the test site was divided into three segments as shown in Figure 8-2. This test site differs significantly from the California site; in particular, this site is an undivided highway.



**Figure 8-2: Demonstration Site through Kendrick Park, Arizona**

Clearly, it is important to evaluate advanced transportation technologies to confirm positive benefit. Consequently, the impetus behind the ASP evaluation was to develop a means of collecting and organizing data to show potential benefit. The overall goals of the Advanced Snowplow (ASP) were to:

- increase safety,
- improve operational efficiency and traveler mobility, and
- demonstrate potential benefits of AVCSS and IVI technologies.

This chapter describes the evaluation methodology, data collection activities, data analysis techniques, results from the data analysis and associated conclusions. In addition, recommendations for further research are made from lessons learned during the project.

### Evaluation Methodology

An evaluation plan was developed to accomplish the task of proving potential benefits associated with combining Advanced Vehicle Control and Safety System (AVCSS) technologies with conventional snowplow operations. This plan considered each of the project’s goals separately by defining specific objectives by which these goals can be met. The objectives described more thoroughly each of the three goals by defining specific areas of focus. To know whether these objectives were being accomplished, measures were developed by which to rank each of the goal’s objectives. Data was needed as input for proving the potential improvement to current snowplow operations. Table 8-1 describes this methodology in detail by listing the project goals, corresponding objectives of these goals, specific measures for the objectives and finally, giving potential data sources from which to gather pertinent information.

<b>Goals</b>	<b>Objectives</b>	<b>Measures of Effectiveness</b>	<b>Data Sources</b>
Improve Safety	<ul style="list-style-type: none"> <li>• Reduce snowplow accidents</li> <li>• Reduce damage to snowplow, other vehicles and infrastructure</li> <li>• Reduce injuries to snowplow operators, or other vehicle occupants</li> </ul>	<ul style="list-style-type: none"> <li>• Snowplow accident frequencies</li> <li>• Repair/replacement costs for snowplows, infrastructure</li> </ul>	<ul style="list-style-type: none"> <li>• Traffic accident reports</li> <li>• Maintenance work reports</li> </ul>
Improve Operational Efficiency & Traveler Mobility	<ul style="list-style-type: none"> <li>• Increase speed of snow removal</li> <li>• Reduce erratic snowplow movements</li> <li>• Reduce road closures/travel delays</li> <li>• Reduce run-off-road incidents, lane departures</li> </ul>	<ul style="list-style-type: none"> <li>• Number of roadway miles cleared per hour</li> <li>• Frequency and duration of road closures and chain requirements</li> <li>• Frequency of snow/ice related incidents, lane departures</li> </ul>	<ul style="list-style-type: none"> <li>• Maintenance work reports</li> <li>• Road closure logs</li> <li>• Chain requirement logs</li> <li>• Operator interviews</li> <li>• Ride-alongs</li> </ul>
Demonstrate Benefits of AVCSS Technologies	<ul style="list-style-type: none"> <li>• Evaluate system performance</li> <li>• Assess operator’s acceptance of the system</li> <li>• Assess system’s ease of operation</li> <li>• Assess perceived benefits of the system</li> <li>• Assess operator’s level of confidence</li> </ul>	<ul style="list-style-type: none"> <li>• Frequency and severity of component malfunctions</li> <li>• Perceived benefits or problems with system</li> <li>• Frequency and severity of human error associated with system</li> <li>• Operator’s assessment of system accuracy and reliability</li> </ul>	<ul style="list-style-type: none"> <li>• Operator interviews</li> <li>• Technology failure reports</li> </ul>

**Table 8-1: Evaluation Goals, Objectives, Measures of Effectiveness and Potential Data Sources**

As part of the evaluation, before-after comparisons related to safety, efficiency/mobility, and technology performance were planned. A valid before-after analysis is highly dependent upon the availability of existing data and the means of collecting appropriate comparison data during

deployment. Much of the “before” data was collected, but, due to the short timeline of this project, a limited amount of “after” data was collected. Another measure included in this study was system performance. This measure considered the reliability of the system in terms of its robustness under the harsh environments.

The evaluation in this study was intended to be both quantitative and qualitative. Due to unforeseen difficulties and limited statistical sampling, the resulting evaluation is principally qualitative. This is a result of the short timespan of this phase (i.e., the demonstration phase) and other data acquisition challenges during the study. Nevertheless, this evaluation proved helpful in that it queried acceptability by snowplow operators and gave the evaluators insight into better data acquisition techniques. The following subsections detail the Measures of Effectiveness used to conduct the evaluation.

### **Measures of Effectiveness**

The evaluation of AVCSS technologies in snowplow operations focused on several areas including safety, operational efficiency and traveler mobility, and system performance. Measures of Effectiveness and corresponding data sources associated with each of these goals are discussed in the paragraphs to follow.

#### *Safety Measures*

Enhanced safety for snowplow operators and other highway users was measured primarily in terms of accidents and injuries. The evaluation considered accidents and injuries to snowplow operators as well as the traveling public. However, the condensed timeline and limited test equipment in this phase hindered the collection of a sufficiently large data sample to perform a statistically significant before-after analysis. Nevertheless, before data was collected to describe the extent of the safety challenges in each of the demonstration areas. Snowplow operator input provided the qualitative input needed to assess acceptability of the advanced technologies in terms of safety.

#### *Operational Efficiency and Traveler Mobility Measures*

This aspect of the evaluation attempted to determine whether AVCSS technologies increased the snowplow operator’s ability to perform snow removal tasks in a more timely or efficient manner. Improvements of this type should translate into decreased operating costs, decreased times to complete certain tasks and reductions in accidents or road run-off incidents. To determine potential increases in operational efficiency, average times for the Advanced Snowplow to complete the instrumented section of road were collected. Since times to complete a “run” were not collected before this study, it was planned to use a before-after comparison between the ASP and the conventional (“sister”) plow. No data was taken in conjunction with the sister plow to compare with the ASP due to a lack of staff designated to take this data.

The time taken to complete one “run” was dependent on several different variables. These variables include general weather conditions, pavement visibility, pavement surface conditions, surface remedies applied to road surface (e.g., salt and sand) and traffic conditions. During operation of the ASP, only one staff person was designated to ride along with snowplow

operators to manually record this data. Qualitative assessments of the system's efficiency were obtained from snowplow operator interviews.

Levels of mobility were measured by the frequency of road closures. The number of road closures is indirectly related to the efficiency of snowplow removal tasks. However, even when the roads are passable, other variables, such as visibility, may prevent use of the road.

### *Technology Performance Measures*

Quantitatively, the performance of the AVCSS technologies was assessed based on technological failures in any of the system components (i.e., lateral position indication and collision warning) or the related infrastructure modifications (i.e., magnets). The evaluation also considered qualitative aspects of the performance of the system. For example, the nature and frequency of human error in the operation or interpretation of the system was examined to determine if changes in the system could enhance its usefulness to the snowplow operator. Operators were asked to rate both the accuracy and reliability of the system, report on perceived benefits and comment on the system's ease of operation. Any other perceived benefits or problems regarding the ACVS technologies were also documented to assist with subsequent modifications or enhancements to the system.

### **Test Setup**

The ASP was shared between California and Arizona during the winter of 1998-99. The plow was purchased by the California Department of Transportation (Caltrans) to be used primarily at the Kingvale Maintenance Yard, near Donner Pass in California. At the same time a "sister" plow was purchased that was identical to the ASP with the exception of the advanced equipment. The plan was to deploy the ASP much like other plows in the area. At times the plow was used in conjunction with other plows in a fleet formation. Other times it was deployed solo to plow or do pre- and post-storm tasks, such as sanding, salting and light clean-up plowing. Several equipment operators were able to try the system, but only three operators spent a significant amount of time on the ASP. Consequently, only these three were considered in the evaluation.

When the snowplow vehicle used for ASP development was purchased, it was specified to have a wing plow on the right side, so that the wing could be used in plowing undivided rural roads. When using the wing plow in the echelon formation commonly used on the divided Interstate 80 test site, the ASP was not used as a lead plow in fleet formation because lead plows typically do not use a wing, or occasionally use a left side wing plow. The lead plow typically plows the middle lane. This initially reduced the time that the ASP spent in the third lane over the magnets. However, the ASP was able to use the magnets when it plowed solo or deployed as the lead without using the wing. This issue was clarified after the first two weeks of testing, and the I-80 operators now consistently use the plow in the lead position. In part because the collision warning system is independent of the magnets, it was used more extensively.

Each State was responsible for setting up the testing schedule based on plowing needs. In mid-March of 1999, the ASP traveled to the Arizona test site for approximately two weeks as part of the bi-state evaluation effort. The Arizona Department of Transportation (ADOT)

Maintenance Yard was in charge of setting up the testing schedule while it was in Arizona. Three of their most experienced snowplow operators were chosen as team leaders. The team leaders were responsible for demonstrating the ASP features and overseeing their use by other snowplow operators from several surrounding districts. Altogether, there were 14 district operators and three team leaders for a total of 17 plow operators in Arizona.

Arizona plow operators spent varying amounts of time on the ASP. The snowplow operators from the surrounding districts spent two to five hours on the ASP, while the three team leaders spent a total of 20, 32 and 48 hours on the ASP. Each participant was asked to fill out a one-page questionnaire after completing several run-throughs with the ASP. They were asked to rank the automated system in terms of safety, efficiency, and ease-of-use of the system. The questionnaire also provided them the opportunity to make additional comments and suggestions. According to ADOT maintenance staff, the winter of 1998-99 in the Flagstaff area was particularly dry. Weather data collected for this area did not include the past winter. Therefore, much of the evaluation occurred under clear and dry weather conditions with the exception of a few small storms.

### Data Collection

Due to the short duration of this phase (i.e., the demonstration phase) of the ASP study, a statistically significant quantity of data was impossible to collect to quantify safety, operational efficiency and traveler mobility improvements from the systems used in the ASP. However, some of the “before” data has been collected to provide insight into the challenges that snowplow operators and the traveling public face during winter driving and to aid in future data acquisition methodologies. The techniques used to gather “after” data and the lessons learned in data acquisition techniques are reported in the following discourse.

This section outlines the methods used to collect the data during the demonstration of the ASP. The first subsection describes the test setup in each of the two States. Next, data associated with each Measure of Effectiveness (MOE) is described in detail. Data gathered from riding along with snowplow operators as they used the plow is shown and discussed. Finally, quantitative data describing the extent of snowplowing challenges in these areas and qualitative data gathered from questionnaires and interviews is shown.

Preliminary safety, efficiency and system performance data was collected with the intent of showing the extent of the challenges in both test areas, and, to document perceived benefits. Table 8-1 (above) shows the data sources associated with each of the MOEs. The specific data elements to be collected and the respective sources of each type of information are described in the paragraphs to follow.

### **Safety Data**

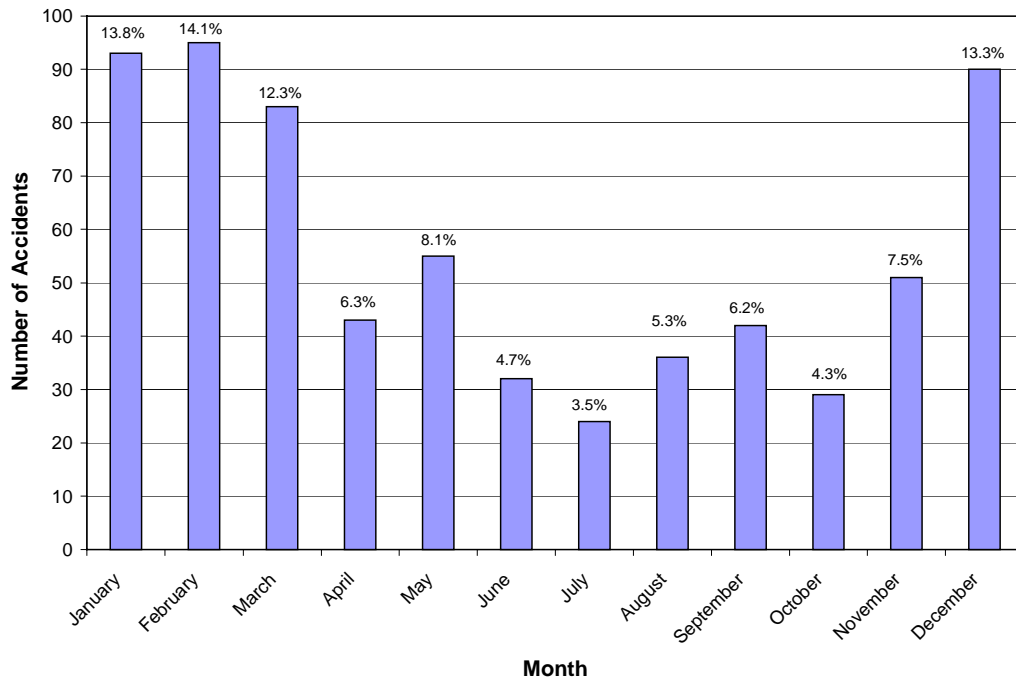
Accident data, maintenance diaries, and operator input were collected to define safety-related challenges associated with snowplow operations. Again, due to the abbreviated length of this phase, quality comparison data was not available. As a minimum, three years of accident data preceding the deployment of the Advanced Snowplow was requested from both Caltrans and ADOT. These agencies were also asked to furnish corresponding cost estimates for snowplow



repairs or associated infrastructure damage for the same period. This information was to be in the form of maintenance diaries and snowplow accident investigation reports. Costs associated with these were also requested for accidents that occurred in their jurisdiction.

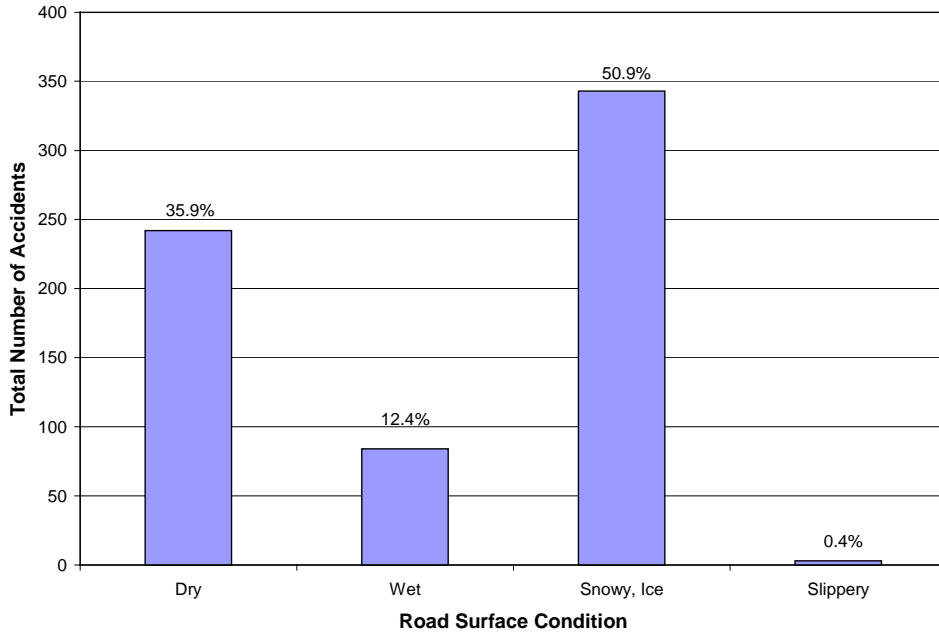
### Accident Data

Accident data was collected for the entire section of Interstate 80 that the Kingvale Maintenance Station is responsible for maintaining. This section includes both directions of Interstate 80 from MP Pla-59.54, near the Highway 20 junction, to MP Nev-9.01, near the Donner Lake Interchange. Much of the divided interstate in this area is three lanes wide, making Kingvale Maintenance responsible for nearly 145 lane-km (90 lane-miles) of interstate.

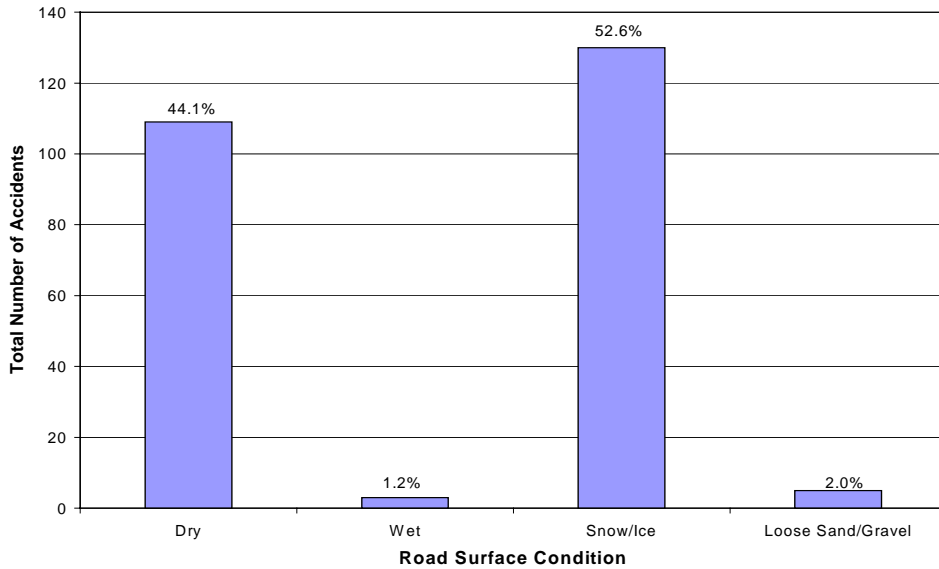


**Figure 8-3: Accident Distribution by Month over Donner Pass, California from October 1, 1995 to September 30, 1998**

The combination of severe winter weather conditions and the high number of vehicles traveling this particular section of road increase the potential for accidents. The annual average daily truck traffic for the area was approximately 3000 trucks per day and the annual average daily traffic (AADT) counts were approximately 26,900 for the westbound side and 27,600 for the eastbound side in 1997 [1]. Accident data collected from October 1, 1995 to September 30, 1998 for the California site showed that near the Kingvale area a little over half (53.6%) of the accidents occurred during the winter months (i.e., December - March), as shown in Figure 8-3 [2]. Most accidents occurred in snowy, icy or slippery road conditions. Figure 8-4 shows the percentage of accidents occurring under various road conditions.



**Figure 8-4: Percent and Number of Accidents for Various Road Surface Conditions over Donner Pass, California from October 1, 1995 to September 30, 1998**



**Figure 8-5: Percent and Number of Accidents for Various Road Surface Conditions around Kendrick Park, Arizona for the Winters between October 1, 1994 and May 1, 1999**

The section of road that the Flagstaff Maintenance Station is in charge of extends from MP 214.5 to 250 on US 180. It has an AADT of approximately 3200, of which approximately 3% are larger trucks and a minimal number of semis, according to ADOT. Accident data for the Arizona test site showed that 130 accidents occurred under snowy and/or icy conditions during the winters between October 1, 1994 and May 1, 1999 (Arizona Department of Public Works), as

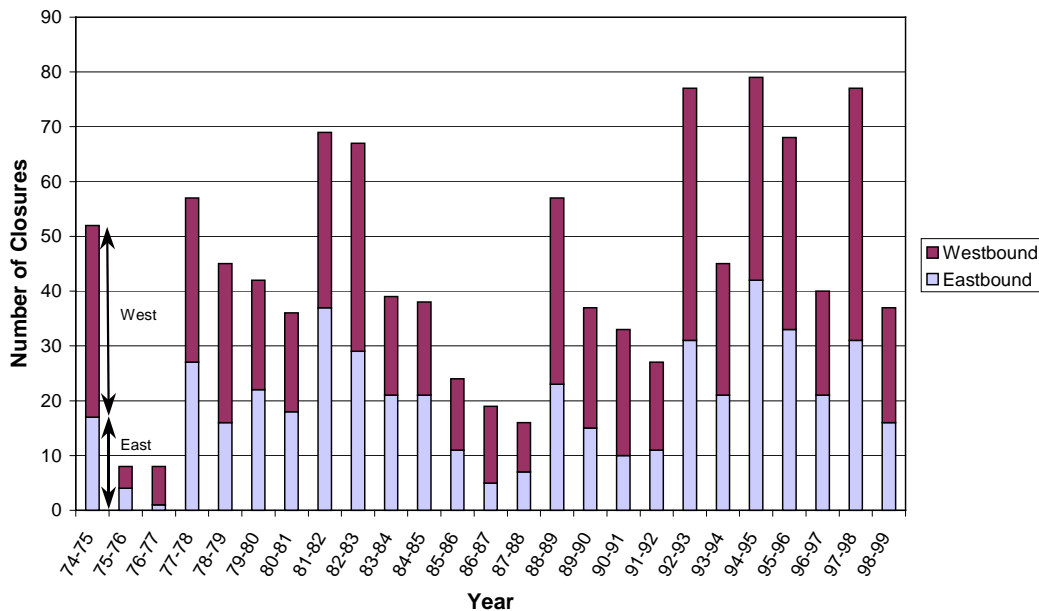
shown in Figure 8-5. Similar to California, over half (52.6%) of the accidents during these winters were snow-related. Data showing the frequency of accidents by month was not available for Arizona

### Operational Efficiency and Traveler Mobility Data

To estimate efficiency and mobility challenges and improvements for these test areas, data related to road closures, snowfall, chain requirements and the run times were gathered.

#### Road Closures

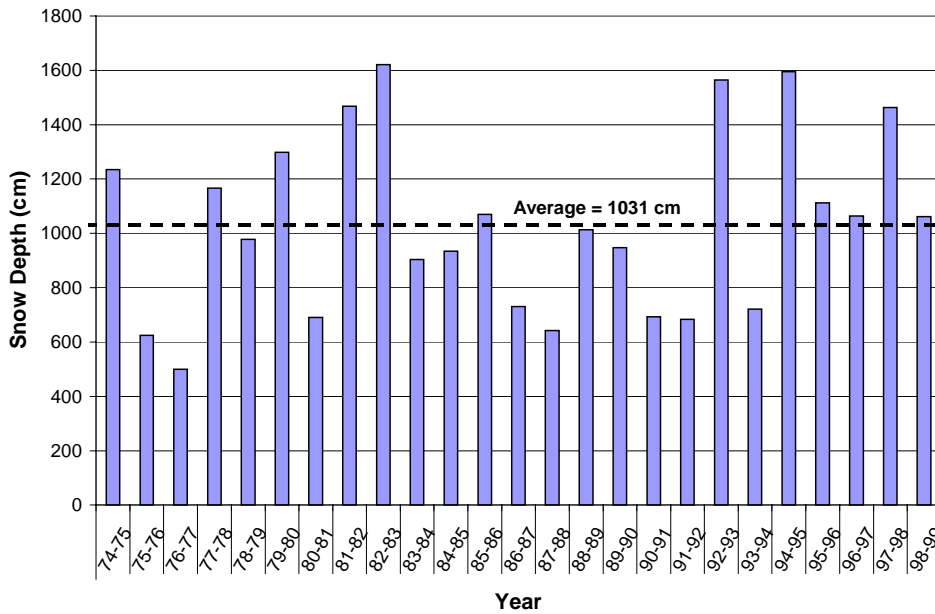
Road closures over Donner Pass on I-80 occur frequently due to large amounts of snow often coupled with other harsh winter weather in the area. At times, snowplows cannot keep up with the volumes of snow and consequently the road has to be closed for certain periods to allow snow removal equipment time to clear the road. For I-80, data from the winter of 1974-75 to the present provided road closure trends. Figure 8-6 shows the frequency of road closures for the area, differentiating the closures for each direction of Interstate. The average number of road closures in the eastbound and westbound directions is approximately 20 and 24 closures per year, respectively; making the average number of road closures in both directions approximately 44 closures per year, according to Caltrans District 3. The Arizona site has only had one road closure in the past five years, according to the District Maintenance Supervisor-ADOT Flagstaff; full closures of US 180 are infrequent since the worst drifting area of Kendrick Park usually can be kept open by intensive maintenance efforts.



**Figure 8-6: Frequency of Road Closures on both Directions of Interstate 80 in California for 1974 - 1999**

Snowfall

Related to road closures, the weather in the area also affects operational efficiency and mobility. Figure 8-7 shows the total snowfall over Donner Pass during the winters between 1974 and 1999. For these years, the average amount of snow over Donner Pass has been approximately 10.3 m (406 inches), based on information from Caltrans District 3. Comparing the number of road closures and the amount of snow in the area shows the obvious relationship between the amount of snowfall and the frequency of road closures.



**Figure 8-7: Total Snowfall near Donner Pass, California for 1974 - 1999**

Snowfall data for Arizona was for Fort Valley near the ASP test area north of Flagstaff. The average snowfall in Arizona for this area has been approximately 2.31 m (91 inches) of snow per year for 1909 to 1999 [19]. Figure 8-8 shows the total snowfall for this area by year as well as the average. Average snowfall at the Kendrick Park test site is typically higher than that at Fort Valley, due to the increase in elevation. The test site elevation of 2440 m (8000 ft) is about 200 m (650 ft) higher than Fort Valley. An increase in snowfall between three and five percent was considered a reasonable estimate according to local weather personnel

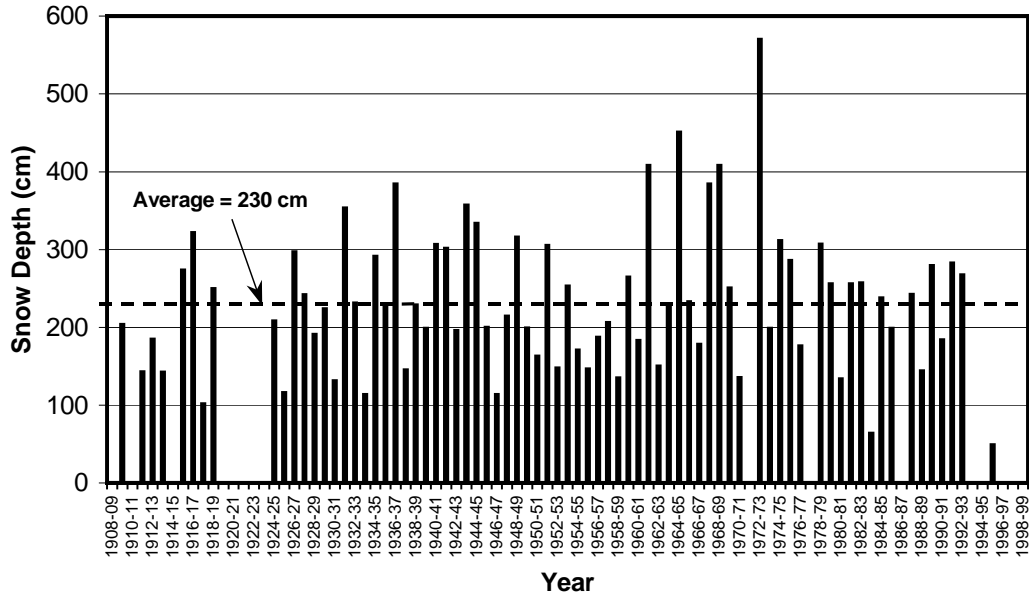


Figure 8-8: Total Snowfall near Arizona Test Site for 1909 - 1996

Another issue affecting the mobility of winter travelers is the number of days that chains are required to cross over Donner Pass. Large trucks that are required to use tire chains oftentimes lose time installing and disassembling tire chains, simply to cross this part of the Interstate. The number of days that chains were required to cross Donner Pass is shown in Figure 8-9. Based on Caltrans District 3 data from 1974-99, chains were required an average of 51 days per year. Data related to chain-requirement closures on US 180 was not documented by Arizona for this time period.

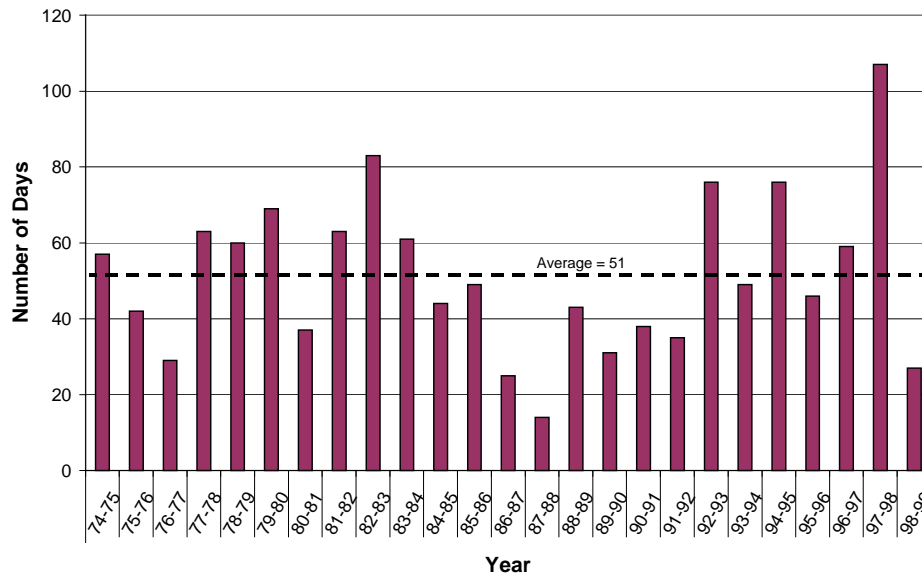


Figure 8-9: Days Chains Required over Donner Pass, California for 1974-1999

Ride-Alongs

Much of the evaluation data used to determine efficiency was gathered using ride-alongs during normal plowing operations. The individual selected to ride along had an evaluation notebook allowing them to record pertinent data such as weather conditions, visibility, pavement surface conditions, and the presence of deicing/friction enhancing remedies. A sample of a data collection sheet used in this notebook is shown in Figure 8-10. Additional space was also provided to elaborate on damage to the infrastructure and plow, should it occur, and to note any unusual driving conditions (e.g. slow trucks).

Collision Warning System ON <input type="checkbox"/> Driver's Side <input type="checkbox"/> Pass's Side <input type="checkbox"/> Front <input type="checkbox"/> OFF <input type="checkbox"/> <input type="checkbox"/> <input type="checkbox"/>		Lane Positioning ON <input type="checkbox"/> OFF <input type="checkbox"/>		Name _____ Date _____ System Failure <input type="checkbox"/> Driver # _____ Concern Button <input type="checkbox"/> Notes <input type="checkbox"/>	
<b>Big Windy</b>	<b>Pole Line</b>	<b>Schweitzer</b>	<b>60</b>	<b>Slight Hill</b>	<b>Flat</b>
Time Start _____ Time End _____	Time Start _____ Time End _____	Time Start _____ Time End _____	Time Start _____ Time End _____	Time Start _____ Time End _____	Time Start _____ Time End _____
<b>Conditions</b> (Check all that apply) _____ Wind/Snow _____ Fog _____ Bright _____ Falling Snow _____ Dark	<b>Conditions</b> (Check all that apply) _____ Wind/Snow _____ Fog _____ Bright _____ Falling Snow _____ Dark	<b>Conditions</b> (Check all that apply) _____ Wind/Snow _____ Fog _____ Bright _____ Falling Snow _____ Dark	<b>Conditions</b> (Check all that apply) _____ Wind/Snow _____ Fog _____ Bright _____ Falling Snow _____ Dark	<b>Conditions</b> (Check all that apply) _____ Wind/Snow _____ Fog _____ Bright _____ Falling Snow _____ Dark	<b>Conditions</b> (Check all that apply) _____ Wind/Snow _____ Fog _____ Bright _____ Falling Snow _____ Dark
<b>Pavement Visibility</b> _____ 0 _____ 50 _____ 100 _____ 200 Feet _____ 300 _____ >300	<b>Pavement Visibility</b> _____ 0 _____ 50 _____ 100 _____ 200 Feet _____ 300 _____ >300	<b>Pavement Visibility</b> _____ 0 _____ 50 _____ 100 _____ 200 Feet _____ 300 _____ >300	<b>Pavement Visibility</b> _____ 0 _____ 50 _____ 100 _____ 200 Feet _____ 300 _____ >300	<b>Pavement Visibility</b> _____ 0 _____ 50 _____ 100 _____ 200 Feet _____ 300 _____ >300	<b>Pavement Visibility</b> _____ 0 _____ 50 _____ 100 _____ 200 Feet _____ 300 _____ >300
<b>Roadway Cover</b> (Check all that apply) _____ Snowpack/ _____ Ice _____ Slush/Wet _____ Clear	<b>Roadway Cover</b> (Check all that apply) _____ Snowpack/ _____ Ice _____ Slush/Wet _____ Clear	<b>Roadway Cover</b> (Check all that apply) _____ Snowpack/ _____ Ice _____ Slush/Wet _____ Clear	<b>Roadway Cover</b> (Check all that apply) _____ Snowpack/ _____ Ice _____ Slush/Wet _____ Clear	<b>Roadway Cover</b> (Check all that apply) _____ Snowpack/ _____ Ice _____ Slush/Wet _____ Clear	<b>Roadway Cover</b> (Check all that apply) _____ Snowpack/ _____ Ice _____ Slush/Wet _____ Clear
<b>Remedies</b> (Check all that apply) _____ Salt _____ Sand _____ Liquid	<b>Remedies</b> (Check all that apply) _____ Salt _____ Sand _____ Liquid	<b>Remedies</b> (Check all that apply) _____ Salt _____ Sand _____ Liquid	<b>Remedies</b> (Check all that apply) _____ Salt _____ Sand _____ Liquid	<b>Remedies</b> (Check all that apply) _____ Salt _____ Sand _____ Liquid	<b>Remedies</b> (Check all that apply) _____ Salt _____ Sand _____ Liquid

Figure 8-10: Sample Ride-Along Data Collection Sheet for the California Site

The instrumented test areas were broken into subsections to allow the potentially variable road and weather conditions to be recorded across the test site. In particular, the California test site was broken into six subsections as previously shown in Figure 8-1. The names of each of the sections from MP 9.1 to MP 5.1 are ① Big Windy, ② Pole Line, ③ Schweitzer, ④ 60, ⑤ Slight Hill and ⑥ Flat. The Arizona site was broken into three subsections. The Arizona site was broken into three sections; ① open, ② downhill and ③ uphill (Figure 8-2). Data was recorded using the data collection sheets previously discussed. It was unknown as to whether the test site needed to be split into as many subsections as it was.

While the ASP was in California, only 29 ride-alongs were made. During these ride-alongs, the lane positioning system was on only four times and the collision warning system was on 21 times. Only one ride-along with snow was made in Arizona: all other ride-alongs were made under dry conditions. Using the data from the California ride-alongs, comparisons were made

between visibility, weather conditions, road cover and deicing/friction enhancing remedies. It was found that out of 29 runs, there were essentially no differences in the road cover and the deicing/friction enhancing remedies used. There were slight differences in the weather conditions, but the biggest differences were related to visibility. Changes in visibility are directly related to changes in weather. For example, differences in the intensity of falling snow will change the visibility. The impact of visibility is believed to be significant enough to warrant installation of dynamic visibility sensors at several locations along the snowplow route, or preferably on the snowplow itself.

The time taken to complete one run was also collected during the ride-alongs. This information was to be related to control data to show potential improvements through the reduction of time taken to perform snow removal tasks. The absence of control data made this impossible. Figure 8-11 shows the times taken to complete one 6.3-km (3.9 mile) run between the Donner Lake Interchange and the Castle Peak Interchange in California. The average time to complete one run was approximately eleven minutes. Run #5 was not a complete run, due to unrelated operating requirements, and run #13 took 79 minutes due because the plow waited for a semi-truck to be pulled out before completing the run. Runs 5 and 13 were not included in the average time calculation. Run #9 shows the effect of very heavy traffic, showing the need for traffic information to be collected. Using the average time to complete a run and the distance covered during the run, the average speed of plowing for the 29 runs where data was collected was approximately 33.8 km/h (21 mph). Because of the limited number of runs in Arizona, times to complete runs were not recorded.

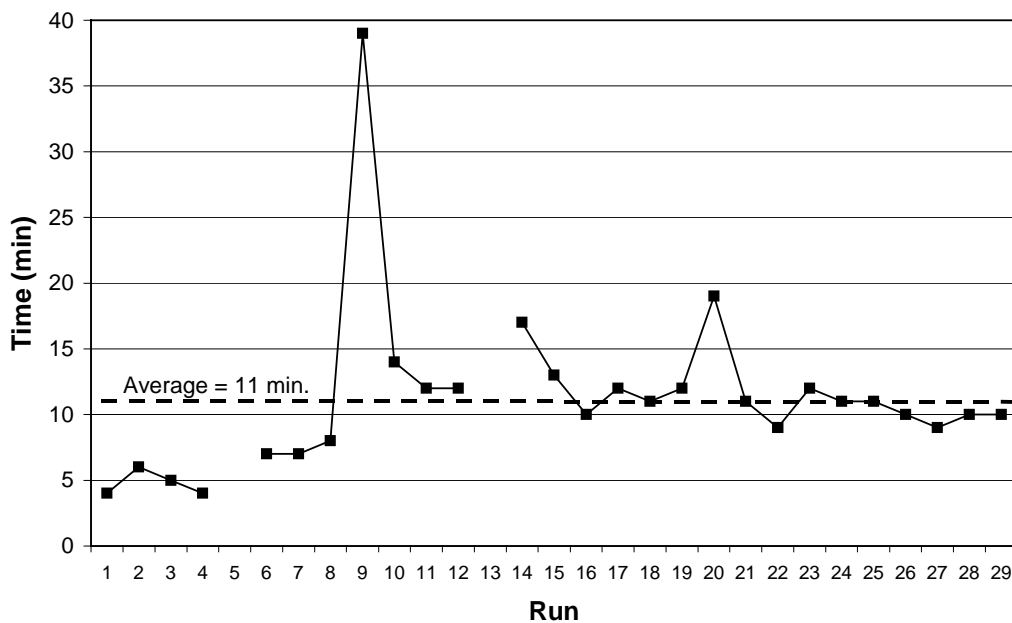


Figure 8-11: Run Times for Ride-Alongs over Donner Pass, California

### Maintenance Data

Maintenance data was requested from both Caltrans and ADOT to assess costs and downtime associated with accidents and run-off-the-road incidents. Consistent data was not available from

ADOT, and Caltrans data was not complete. Caltrans District 3 data (shown in Table 8-2) indicates that a total of 92 accidents that required repair/maintenance occurred between 1994 and 1998. Dollar figures stated only cover the repairs made to the Kingvale maintenance equipment, not to others possibly involved in the accident/incident. Further investigations must be made to calculate dollar amounts spent in litigation, etc.

Arizona keeps similar maintenance cost records of damage to their snowplows. The ADOT figures are also likely to be low because much repair work, such as damaged blades or frame mountings, is simply budgeted in advance as winter maintenance operational costs. Finally, figures on property damage to private vehicles are not released due to liability issues.

Year	Total Number of Accidents/Incidents	Total Cost of Repairs
1994	9	\$750
1995	26	\$4100
1996	23	\$8550
1997	8	\$1600
1998	26	\$5760
1999	4*	\$2400

\*Data not yet complete

**Table 8-2: Total Reported Accidents and Associated Maintenance Costs to Maintenance Equipment out of the Kingvale Maintenance Shop in California**

### **Intelligent Vehicle Technology Performance**

The primary source for system performance data was the technology failure reports prepared by the ASP maintenance staff. These reports detailed the nature and frequency of component malfunctions and were used to assess the accuracy and reliability of the system. This data was supplemented by the information obtained in interviews with the operators of the Advanced Snowplow as discussed in the following subsection.

Most of the downtime that occurred during the demonstration of the ASP was a result of water infiltration into the magnetometers. The magnetometers, which sense the magnets placed in the road, hung from the frame near the front and the rear of the ASP, making them highly susceptible to water, ice and salt as well as any large object that may be on the road. In terms of man-hours, the plow required a total of 176 man-hours of maintenance. Of the 176, 156 man-hours were required to mitigate problems associated with water and salt infiltration into the magnetometers. The remaining 20 hours were spent sealing the equipment enclosure behind the cab of the ASP and upgrading the LCD display and its mounting brackets. The magnetometer enclosure system is being redesigned in Phase II (ASP-II) of this research, based on lessons learned in the current research.

### **Snowplow Operator Interviews**

In-depth interviews were conducted with snowplow operators who used the Intelligent Vehicle in the demonstration phase of the study. The interview program presented in



Appendix A served as a guide for the interviewer, but did not restrict attempts to gather useful information. It was up to the interviewer's discretion to ask additional questions. In general, the interviewer solicited detailed information from the individual operators to assess perceived benefits of the system, as well as any difficulties encountered with the various technologies. A major advantage of personal interviews, compared to written questionnaires, is the opportunity for the interviewer to solicit anecdotal information, examples, or more detailed responses from the subject. In general, the topics covered in the snowplow operator interviews included:

- the operator's overall impressions of the system,
- an assessment of system components in terms of safety and efficiency,
- system failures or human error and
- recommendations for modifications or enhancements to the system

### *California Interviews*

Telephone interviews were conducted with three snowplow operators in California. Although more than three operators used the snowplow, these three operators used the ASP more extensively than the other participants and were thereby considered more significant in terms of their insight. Three snowplow operators having four, six, and fourteen years of plowing experience were interviewed regarding their experience with the ASP. At the time of the interview, the three operators had spent approximately 70, 80 and 150 hours on the ASP, respectively. All three operators felt that they had good training regarding the advanced equipment on the snowplow and felt very prepared to use the ASP.

When asked to rate and comment on ease-of-use, safety benefit, and increasing plow efficiency of the advanced equipment the averages, on a scale of one to ten, all were close to ten. The average for ease-of-use was eight, safety benefit was nine, and increasing plow efficiency was eight. Some comments made regarding the system ease-of-use were that the screen was too large, too bright, created too much glare, and rotated and moved too much. Other comments included placing the screen in a new location, away from the other controls. Comments about the safety benefits of the equipment were that it was most beneficial when visibility was poor by helping the operator know where they were with respect to their lane. One operator indicated that they do not put total faith in the electronics because there is too much at stake. Comments regarding ease-of-use are being factored in during Phase II modifications.

Lane Positioning: All three operators felt that the lane positioning system increased their perceived level of safety, especially in whiteout conditions. All operators also felt that the equipment reduced worry regarding their position on the roadway. Since lane position is very important to the operators, they glanced at the screen very frequently. All three operators agreed that the system increased operational efficiency. It was also said that stress level was reduced, less erratic maneuvers were made, and, when traffic permitted, plowing speed was increased. All agreed that this system was most helpful in conditions of low visibility, i.e., fog, heavy snow or darkness.

Collision Warning: When asked if this system increased the operators perceived level of safety, two of the operators thought it increased their level of awareness. One operator stated

that the system was not working very well. He indicated that the system was picking up guardrails, overhead signs, snow banks, and other objects that were not necessarily in the travel lane. This operator used the system when it was initially deployed in California when the ASP project team was still working out some of the bugs in the system. All three operators felt that the system increased their operational efficiency, but not necessarily their speed. They all felt that they had a higher confidence factor because of the heightened awareness of potential hazards. Again, all operators agreed that this system was most helpful in low visibility conditions. All three operators also agreed that the system was not an annoyance, but was ignored when the operator felt that it was providing false information. Two of the operators stated that the system was not always working correctly. Again, operator feedback on the CWS is guiding modifications for ASP-II, which will include significant modifications to the sensors, configuration, and algorithms.

Human-Machine Interface: When ASP operators were queried regarding the human-machine interface, all three operators thought that the screen was easy to read, other than the brightness level. Two out of the three operators felt that the system gave them enough warning to react to potential hazards, the third thought that it didn't give them enough time if they were in traffic. The same driver felt that they just need to know the territory so that the operator does not confuse a potential hazard or obstacle with existing infrastructure. When asked if the system provided enough information one operator said the information was adequate, one operator thought that showing a landmark to show general location would be good, and the last operator felt that the information was good, but could be down-sized a bit to make a tidier package. Some of the issues raised during the California interviews have now been addressed; others are being considered in ASP-II.

Failures and Suggestions: All three operators had part of the system fail while they were driving. The first operator had both the radar and guidance systems fail: the radar would react although there was nothing in front of it, there was moisture in the front and rear magnetometers, and the rear magnetometer mount came loose once. The second operator stated that the screen went blank once and the third operator said the lane positioning would jump around during runs. If the third operator had followed the system when it failed it would have led him out of his lane. The sources of these failures have been identified and addressed in the course of the current research.

Some suggestions to improve the system included:

- possibly using a head-up display (HUD),
- making the brightness of the screen adjustable,
- making the screen smaller and
- making the magnetometers more robust so the operators do not have to worry about them.

The use of a HUD was considered early in the project. A HUD-based display was rejected for reasons discussed in Chapter 5. However, the research team continues to evaluate the possible use of a HUD as the technology advances. The other suggestions, regarding the screen and the magnetometers, have been addressed or are being factored in during Phase II research.

### *Arizona Interviews*

Telephone interviews were conducted with the three team leaders to document their experience with the ASP. At the time of the interviews, each driver had put in about ten hours on the snowplow with all of the hours being on dry roads. These team leaders have between seven and twelve years of experience on a traditional plow and all felt comfortable on the ASP regarding the advanced equipment.

All three team leaders were generally satisfied with the new components on the truck. On a scale of one to ten with ten being completely satisfied, the average between the drivers for ease-of-use of the plow and advanced equipment was a nine out of ten. They also ranked the safety benefit and increase in efficiency of the advanced plow. These averages were ten and eight, respectively. Overall, the team leaders recognized the benefits of the ASP.

Lane Positioning: All team leaders agreed that the lane position display increased the perceived level of safety since lane position is one of the primary concerns of snowplow drivers. They felt that lane positioning would be most helpful in whiteout conditions and during the nighttime. Two of the three team leaders felt that it would allow operators to increase their speed and efficiency during plowing, especially in corridors with low visibility.

Collision Warning: There was some disagreement between the team leaders about the collision warning system. For perceived level of safety, one team leader didn't feel the collision warning system increased the level of safety, one felt it increased it to a certain extent and one believed that it did increase the perceived safety. The same feelings existed with the increased efficiency of the system. One operator thought it would increase efficiency, another did not and the last felt that it would increase his awareness and possibly increase speed on the interstate. Two of the three drivers agreed that the system would be helpful in conditions of low visibility, but should be used as more of a backup. The last question discussed was how annoying the collision warning system was and if the driver ignored the system. Only one of the three drivers was annoyed with the system, but two admitted to ignoring it on occasion. Several factors influenced the Arizona testing with respect to the CWS. First, the tests occurred in clear weather, so that the operators drove at higher speeds than would occur during typical plowing operation; thus the CWS provides less time to react to an obstacle. Also, as noted in Chapter 5, the CWS was optimized for the California road configuration (divided interstate), and not adjusted for the significantly different Arizona site, an undivided rural route. The system did not detect objects perfectly; false positives, misses, and warnings that did not readily disappear were not uncommon. In future iterations, a more general CWS capable of better operation in a wide range of road configurations will be investigated.

Human-Machine Interface: When discussing the machine with the team leaders there were three areas covered including how easy the display was to read, whether the display gave adequate time to react to potential hazards, and whether the display showed enough information. The first team leader felt that the system was easy to understand, gave him plenty of warning to make evasive or corrective measures, but did not think there was enough information displayed. The second team leader felt that the display was difficult to read, did not give adequate time to react to hazards and thought that the system needed to include milepost symbols or landmarks to help the driver keep track of their location. The last team leader felt that the display was

somewhat confusing, but that it gave adequate warning of hazards and a sufficient amount of information.

Failures and Suggestions: There were no system failures in the time that the team leaders spent with the Advanced Snowplow. There were, however, some suggestions made about how to improve the system. These suggestions were to:

- move the display so that the top of the display unit was three to four inches above the dash board,
- make the color of the vehicle a different color than the pointer on the display,
- tilt the road to look forward instead of looking at the truck in plan view on the display,
- have the system sense hazards farther down the road to increase reaction time, and
- dedicate a small portion of the display to show a more macro placement of the truck on the route.

In summary, most of the responses regarding the addition of advanced technologies on snowplows were very positive. Table 8-3 shows how each of the six operators interviewed responded to the questions asked during the interviews. A positive sign (+) indicates that the operator felt positive about the particular question, a zero (0) indicates a neutral or indifferent response and a negative sign (-) indicates a negative response.

State	Driver	General						Lane Positioning			Collision Warning			Human-Machine Interface		
		Operator experience (yr)	ASP experience (hr)	Training	Safety	Efficiency	Ease-of-use	Safety	Efficiency	Ease-of-use	Safety	Efficiency	Ease-of-use	Ease-of-use	Timeliness	Quantity of info
CA	1	4	70	+	7	8	9	+	+	+	-	+	+	+	+	+
	2	6	80	+	10	10	9	+	+	+	0	+	+	+	+	+
	3	14	150	+	8.5	7	6	+	0	+	0	0	0	+	0	+
AZ	1	7	40	+	9	10	7	+	+	+	-	-	-	+	-	-
	2	9	32	+	10	10	7	+	0	+	+	+	+	+	+	+
	3	11.5	8	+	8	10	9	+	+	+	0	+	0	+	+	0

**Table 8-3: Summary of Snowplow Operator Responses based on Results from Interviews**

All of the snowplow operators indicated that safety was the number one concern to them as they perform winter maintenance tasks on the highways. Looking for buried or stranded cars, staying in their lane, and being able to see beyond the front of the plow were all high priority to them. In general, the average score given with respect to improving safety was 8.75/10. All of the plow drivers felt very positive with regard to the lane positioning information in terms of safety; all giving it a positive rating. Conversely, the collision warning did not rate as highly in terms of safety. As noted above, the CWS is targeted for significant revisions based on operator feedback.

Efficiency is also a big concern to snowplow operators since taking a longer time to clear the road of snow oftentimes allows more snow to be packed onto the surface creating icy conditions. Icy roads lead to decreased mobility for travelers, which translates into less productivity of snowplow operators due to decrease in the speed of traffic. The snowplow operators felt very positive regarding the ASP's ability to increase their efficiency, giving it an average general score of 9.17/10. They were positive that both the lane positioning system and the collision warning system increased their efficiency on an individual basis.

It was the designers' desire to create an advanced system to provide pertinent and timely information to the user, without associated difficulty of operation. In terms of ease-of-use, the snowplow operators were fairly positive, giving the systems an average general score of 7.83/10. They were confident in using both the lane positioning system and the collision warning system. General questions regarding the human-machine interface were also asked that provided input into how the snowplow operators felt the system communicated the necessary information to the user. In terms of readability and ease-of-use, the snowplow operators were very positive. Also, five of the six operators felt that the system provided timely and a sufficient amount of information.

### **Arizona Questionnaires**

Questionnaires were also used as part of the evaluation for snowplow operators in Arizona. After each of the operators used the ASP they were asked to complete a two-page survey that was put together by PATH. Note that questionnaire respondents were the additional 14 short-term Arizona operator trainees, rather than the more experienced Arizona and California team leaders / primary operators documented in the previous section. Questions were asked relating to overall ease-of-use of, and whether operators liked the system. Results from this exercise were very positive. Operators felt the system was very easy to use, liked the system overall and thought they would like it more with increased use. When the lane positioning system and the collision warning systems were considered separately, operators felt slightly more positive about the lane positioning system than the collision warning system. Lastly, drivers were asked to assess the systems potential to improve safety and efficiency. On a scale of one to ten, safety rated a 9.18 and efficiency rated a 9.12.

In addition, Arizona snowplow operators were asked to provide comments regarding changes/modifications they would make to the system. Some of these modifications included:

- add predictive arrows to the screen to show upcoming bend in the road

- add milepost markers to the screen
- show more road in front of predictive marker
- differentiate between fixed objects, oncoming vehicles and other objects as part of the collision avoidance system.
- make the screen output multi-dimensional and virtually display hazards
- add speed and RPM to screen
- lengthen top of display so the predictive marker sets more in the middle of the screen
- give more time to react, information needs to be more predictive
- add feature that uses a big red arrows to point you back into your lane when you have departed completely from the magnet path
- put display screen closer to steering wheel and window

These suggestions are being considered in Phase II research.

### Evaluation Conclusion

Maintaining winter areas such as Donner Pass in California and Kendrick Park in Arizona is a difficult task due to the high amount of snow accumulation, severe working conditions, and high volume of traffic. Adding advanced technologies is not always the best solution to a problem, and may even amplify the problems by causing sensory overload, etc. Any equipment that is added to the cabs of these snowplows must provide sufficient, timely, accurate and appropriate information without causing unnecessary distraction or annoyance. To assess whether these technologies are a step in the right direction, a preliminary evaluation was conducted.

Data was collected, organized and analyzed to provide input to each of the Measures of Effectiveness as input into the goals of the ASP project: improve safety, increase efficiency and demonstrate benefits of AVCSS technologies in maintenance equipment. Unfortunately, the short timeline of this demonstration phase of the project did not allow a sufficient amount of data to be collected. Nonetheless, preliminary data was collected as part of the analysis. The data that was collected was organized to show trends and challenges in the test areas as well as provide insight into potential benefits of adding advanced technologies to snowplow maintenance equipment.

Preliminary data was also collected from participating Departments of Transportation, maintenance officials, weather bureaus and snowplow operator questionnaires and interviews. Accident data showed that, on the average, over half of the accidents that occurred in the California and Arizona demonstration sites were during snowy/icy road conditions. Other data showed that, for California, road closures are frequent as well as the number of days that chains are required. Road closures were not an issue at the Arizona site.

Ride alongs were conducted to record pertinent data related to weather, visibility and traffic conditions during plowing operations. Even though only a limited number of ride-alongs were done, it was evident from the information gathered that automation of much of the ride-along data collection is necessary.

As part of the qualitative portion of this evaluation, the snowplow operators were asked questions that queried their impressions of the ASP with respect to improving safety, increasing operational efficiency and traveler mobility and its ease-of-use. Responses to these questions were generally very positive. The snowplow operators were open to new methods of improving snowplow operations in terms of safety and efficiency and thought that the systems implemented as a part of this study were a step in the right direction.

### **Challenges and Recommendations for Further Research**

As with many research projects, there are many challenges to collecting representative and meaningful data with which to draw a conclusion. The main challenges faced during this phase of the project were related to the lack of data. This was, in part, due to three factors of influence: 1) equipment scheduling, 2) data collection methods and 3) short duration of the demonstration phase.

Because this study was a bi-state effort, the ASP was shared between California and Arizona. The snowplow spent the bulk of the time in California since the plow was assigned to the Kingvale Maintenance Yard. Because of this, the plow only spent about two weeks late in the plowing season at the Arizona demonstration site. The brevity of its stay in Arizona made it difficult for snowplow operators to use the ASP for a sufficient amount of time under plowing conditions. Additionally, the 1998-99 snow season in Arizona was particularly light, further limiting actual plowing experience of the Arizona participants. This could be remedied by instrumenting additional ASP vehicles, thereby allowing each state to participate simultaneously, but would of course increase the deployment cost.

It was envisioned that the ASP would be used as the lead plow during fleet plowing operations in California since it had the ability to “see” rather than “feel” the road during whiteout conditions. As noted earlier, the ASP was purchased with a right-handed wing plow attached to the side of the truck. To be used as a lead plow, the truck should have a left-handed wing plow, or no wing at all. This is because the lead plow clears the middle lane (out of three lanes) using the plow blade mounted on the front of the truck, and occasionally uses the left wing plow to clear part of lane one (left-most lane). To maximize the amount of lane-miles plowed, the ASP typically was not used as a lead plow during the first two weeks of testing. However, since the ASP had the “eyes” to potentially see through whiteout conditions, it would have been beneficial to use it in the lead position. In fact, one of the California snowplow operators indicated that he felt held back by the other plows during plowing operations at night in a snowstorm. He requested that he be the lead plow regardless of the wing plow location, and was able to increase the speed of the plow fleet significantly. From this initial evaluation, it is suggested that the ASP be the lead plow by purchasing appropriate attachments, etc. For the current effort, this issue was clarified with the operators and resolved early in the testing season.

Ride-along data supporting the efficiency evaluation was difficult to collect since data acquisition was manual. Efficiency data was collected through project participant ride-alongs in the snowplow. The individual responsible for collecting data was to record data related to weather conditions, visibility, roadway cover and friction enhancement/deicing remedies used. Individuals were also to note any unusual traffic conditions, plowing activities, etc. that would explain the nature of the run. From the analysis in the previous section, it was concluded that data related to the roadway cover and deicing/friction enhancement remedies were similar enough across the entire site to be able to record one condition for each plow run.

Because winter storms are oftentimes unpredictable, ride-along data acquisition needs to be ready at all times. It was not feasible to employ several staff members to ride along with the ASP through all of the shifts. Data acquisition can become quite a task since plowing activities often occur 24 hours per day. Under these circumstances, it would be impossible for one person to perform all of the ride-along data acquisition. Incorporating additional data collection personnel further complicates the data since data such as visibility may be interpreted differently depending on the individual. It is therefore suggested that data collection be mostly automated, negating the need for a ride-along data collector. Most importantly, visibility, traffic and weather-related data need to be collected.

The final challenge was related to the types of data needed to perform a valid evaluation. Since this project was not conducted in a laboratory setting, the practical considerations of snow removal operations limited the feasibility of including comparison sites in the analytical design. Ideally, the ASP and a conventional (“sister”) snowplow should have been deployed on the same roadway segment, traveling in opposite directions, at the same time. This method would have eliminated much of the bias introduced in the analysis from variations in roadway geometry, terrain, weather, or time; however, the level of experience and skill of the operators would have been different, as would the roadway grade in most cases. However, no ride-alongs were conducted with the non-instrumented “sister” plow due to the lack of designated staff for such purposes.

An alternative method of comparison that can be used is simply turning the advanced technologies off to collect control data. This would allow comparisons between the two conditions to be made. However, turning off the system would reduce the amount of evaluation data in half. In addition, runs would be separated in time, weather, and roadway conditions.

To summarize, the challenges were related to:

- sharing of the plow between states,
- snowplow fleet position (lead plow status),
- ride-along data acquisition and
- collecting control data.



Some potential solutions to these challenges might be to:

- develop a more consistent share between participating states,
- purchase and install appropriate hardware for the ASP so it can be used as the lead plow,
- automate as much of the data acquisition as possible (i.e., traffic counts, visibility, and weather), and
- adjust scheduling so a non-instrumented snowplow can be used to collect control data.

Overall, the testing and demonstration of the ASP in California and Arizona have been a success since it allowed snowplow operators the opportunity to experience new means of improving the safety of winter-related maintenance. Feedback gained from this experience will allow future field operational tests to be a success due to changes in data acquisition and deployment. Associated evaluations will also be a success since a more representative amount of data will be acquired. Finally, many of the operator observations as well as the experiences of the research team are already leading to significant improvements in the system. Many of these benefits could not have been obtained without the advantages of real-world testing.



## CHAPTER NINE

### CONCLUSIONS AND FUTURE RESEARCH

#### Conclusions

The Phase I Advanced Snowplow was deployed to the Caltrans maintenance fleet in December, 1998. Caltrans operators used it on a regular basis through the winter of 1998-1999, sometimes continually for days straight during periods of intense storm activity. Additional testing occurred in our partner state, Arizona, on US-180 near Flagstaff. Research engineers continued to analyze and improve the performance of the system, as well performing preventive and responsive maintenance on the system, throughout the season's testing. Data regarding operator use of the system was collected during ride-alongs by the research team. Analysis of this data was presented in Chapter 8, and early indications are quite positive. Early operator feedback has already led to improvements in the HMI display. Issues that arose during testing have also led to revisions in the hardware design and implementation.

The Phase I ASP as deployed into the Caltrans fleet is best viewed as a first-generation prototype. Many lessons have been learned based on this research effort. The research team has developed a better understanding of the true nature of the harsh operating conditions the system must overcome. In addition, the team has a far better understanding of the entire snow removal operation, based on time spent at the test site through the current winter season. With this experience, plans are in place to develop a second-generation system, advancing the robustness of the hardware, enhancing and further testing the HMI, and developing quantitative Measures of Effectiveness to allow comparison between the California Advanced Snowplow platforms and similar systems developed in other states. This research effort is now in progress, and is referred to as ASP Phase II, or ASP-II.

The results of the Advanced Snowplow project clearly demonstrate the safety and efficiency that can be obtained through judicious application of Intelligent Vehicle technologies for a maintenance vehicle operating in a harsh and hazardous environment. The system eases the workload of the snowplow operator, while simultaneously enhancing the safety and efficiency of the operation. This technology is applicable across the Special Vehicle category (maintenance, police, fire, and emergency medical), where operators must perform their duties in all conditions in order to ensure public safety and availability of facilities. In fact, in the long term, there are no limitations to the application of the ASP technologies, i.e. this technology is applicable across all vehicle platforms, including light vehicles, commercial vehicles, and transit vehicles.

#### Future Research and Development

Through operator interviews, direct experience with the snowplow operation and environment, and detailed inspection, testing, and maintenance of the vehicle itself, the research team has identified a number of areas for future improvement of the ASP. Some of these areas should be considered new research issues, while some fall under the category of development improvements. Many of these areas will be addressed under the Phase II research program.

Others will be addressed through future development and commercialization of the ASP technology.

Specific issues in terms of hardware ruggedization have been identified. Many of these issues have already been addressed, or are being resolved as of the writing of this report. The biggest area of concern, water infiltration and corrosion of the magnetic sensors, has led to a complete redesign of the ASP magnetometer enclosure system. The new enclosure system is a significant improvement, and is being tested in an environmental chamber as part of the early Phase II research. Based on the results of this testing, the enclosure design will be modified in the unlikely event that tests indicate a need for that, and the enclosures on the truck will be updated to the new design. The old sensor enclosures have already been removed from the vehicle. As a longer term solution, the current magnetometer sensor design should be revised for the current application, resulting in a more ruggedized sensor, with possible side benefits of reduced cost and reduced installation requirements. The AHMCT team is currently investigating such a system.

A major goal of future research and development will be to reduce the total system cost. In pursuit of this goal, the research team has investigated the possibility of using the ASP technology with only front magnetic sensing, i.e. completely eliminating the rear sensor bar. Tests at the end of the ASP project clearly indicate that this mode of operation is feasible at snowplow speeds (although not at standard highway speeds), so that for snowplows, only the front sensors are required. Thus, the number of sensors, currently one of the high cost items on the vehicle, is cut in half.

In addition, other modes and algorithms for the lateral sensing should be investigated. The team expects to look into integration of magnetic sensing, GPS, and inertial measurement. Also, the possibility of using magnetic tape in conjunction with or instead of discrete magnetic markers may also be investigated.

Numerous suggestions were made regarding the HMI, many of which can be found in Chapter 8. All of these suggestions will be integrated early on in Phase II research, and a coordinated plan will be developed. Many of the suggestions are known to run counter to accepted human factors research; in addition, some of the suggestions contradict others. The human factors researchers will apply their expertise to address the issues of greatest relevance. As part of this effort, future focus groups will be convened to solicit user input, and develop an acceptable next-generation ASP HMI. Some suggestions related to hardware improvements, e.g. brightness control, have already been implemented as part of this project. Others, such as reducing the display size, will be addressed in Phase II research and development.

The CWS will receive increased attention in future research. First and foremost, the sensor system will be augmented with an added radar sensor, so that obstacles can be detected both in front of the vehicle and in front of the wingplow. So that the system will be able to provide rough lateral obstacle placement, the sensor will be updated to an improved commercial radar, probably the Eaton Vorad EVT-300. The CWS algorithm will be modified to take advantage of this lateral information, providing a CWS HMI that correlates actual lateral obstacle location with a logical representation of this location on the display. Specific approaches for the representation will be determined as part of the HMI focus group work. In addition, due to the nature of driving and

driver behavior in the Donner Pass area, it will be desirable to develop or find commercially available systems for detecting “soft targets” (i.e. humans) in the roadway, and alerting the operator. The CWS system must also be made more universal, so that the same system that works well in a six-lane divided interstate will also perform well on a two-lane rural highway. It is also desirable to add some form of rear collision warning, as this is a primary mode of snowplow-related accidents; however, actual alarm and alert methods for this approach must be determined. Finally, the system may also require multiple sensor integration (e.g. inertial, magnets, steering sensing) to reduce false alarm rates, as well as to improve redundancy and fault tolerance.

Further data collection, both on the vehicle and from archives and databases, must be performed to provide a more detailed cost-benefit analysis of the system. First, the need for such a system must be further documented by available accident, weather, and road closure information. This has been done to an extent in the current project, but further work is required here. In addition, more extensive data collection, including video, weather detection, and visibility measurements, must be performed with the research system, and perhaps with other similar vehicles. Additional provision must be put in place to support such data collection, and to facilitate the collection, transfer, and analysis of this data. Wireless links in the maintenance bays may be an attractive option, as they present the possibility of remote diagnostics, data transfer, and system logging. In addition, to support researcher transport, system and infrastructure diagnostics and debugging, and equipment transport, it will be desirable to develop a fully instrumented support platform for winter maintenance activities.

Beyond the technology provided by the ASP itself, it seems promising to consider the winter maintenance as an overall system, and consider the possibility of coordination and/or automation of numerous activities through application of AVCSS and communications technology. It appears possible to provide the type of driver assistance that ASP obtains by way of magnets, but to give this to follower plows through some form of relative positioning and inter-vehicle communication, thus providing driver assistance for an entire echelon plow formation, greatly enhancing the safety and efficiency of the plowing operation. In addition, early investigations indicate a need for an opportunity to apply full lateral and longitudinal vehicle control in the case of a rotary snow blower, also known as a rotary plow. Here, the benefits are increased safety as well as reduced damage to the snow blower and to infrastructure. A project is currently being developed to address this issue. Similar work may be useful in the case of snow graders. Again, considering all the winter maintenance activities as a system, and applying the appropriate data collection, communication, control, and coordination, holds great promise for significant improvements in safety and operating efficiency. Testing these approaches with multiple vehicle types, and over multiple test sites, should eventually lead to systems that can be deployed into the maintenance fleet.

Finally, as similar work is occurring in other states, it is critical to develop methods of quantitatively comparing research results in an unbiased manner. As part of this effort, the various research teams must work in a cooperative fashion to develop quantitative Measures of Effectiveness (MOEs), which will then dictate the needs for future data collection and analysis. As the systems being developed have some significant differences with respect to technology and overall approach, it is critical that these MOEs are developed in a way that isolates these differences, and allows for a fair and unbiased comparison of the systems.

Many of the mentioned improvements and new research are already under way in the Phase II research program, “Development of an Advanced Snowplow Driver Assistance System (ASP-II).” In addition, the research team is planning development of multiple snowplows using the technology from the ASP, including improvements from the Phase II work. These plows will be tested at sites currently being developed in California, as well as in other partner states. The rotary plow automation is in the planning stages, and is expected to commence during the winter of 1999-2000. Additional support research is already in progress, including automation of the infrastructure surveying and installation. This research should drastically reduce this aspect of the system cost, and greatly improve the overall cost-benefit of the technology.

## REFERENCES

1. California Department of Transportation, Traffic Operations Program, "Traffic and Vehicle Data Systems," [www.dot.ca.gov/hq/traffops/saferesr/trafdata/1997all/r071-80i.htm](http://www.dot.ca.gov/hq/traffops/saferesr/trafdata/1997all/r071-80i.htm), 1997.
2. California Department of Transportation, "TASAS Selective Record Retrieval Database," 1999.
3. Calspan, "Precursor Systems Analyses of Automated Highway Systems: Lateral and Longitudinal Control Analysis," Federal Highway Administration Report No. FHWA-RD-95-122, 1995.
4. T. Dingus, D. McGehee, N. Manakkal, S. Jahns, C. Carney, and J. Hankey, "Human Factors Field Evaluation of Automotive Headway Maintenance/Collision Warning Devices," *Human Factors*, **39**, p. 216-229, 1997.
5. K.-T. Feng, H.-S. Tan, M. Tomizuka, and W.-B. Zhang, "Look-Ahead Human-Machine Interface for Assistance of Manual Vehicle Steering," to appear in *American Control Conference*, 1999.
6. J. Guldner, S. Patwardhan, H.-S. Tan, and W.-B. Zhang, "Coding of Magnetic Markers for Demonstration of Automated Highway Systems," in *Preprints of the Transportation Research Board Annual Meeting*, 1997. Washington, DC.
7. J. Guldner, H.-S. Tan, and S. Patwardhan, "Analysis of Automatic Steering Control for Highway Vehicle with Look-down Lateral Reference Systems," *Vehicle System Dynamics*, **26**(4), p. 243-269, 1996.
8. G.F. Jacobs, D.M. Hopstock, L.D. Wald, and D.C. Knoll, "Feasibility Demonstration of a Lateral Position Indication System Based on Magnetic Pavement Marking Tape," in *Third Annual World Congress on Intelligent Transportation Systems*, 1996. Orlando, FL.
9. Y. Kajiya, K. Ishimoto, M. Honda, and K. Kawamura, "ITS Technology R&Ds for Winter Traffic and its Impact," in *Third Annual World Congress on Intelligent Transportation Systems*, 1996. Orlando, FL.
10. T.A. Lasky, W.-B. Zhang, and M.G. Jenkinson, "Advanced Snowplow Program on the Road," in *Intellimotion*, 1998.
11. H. Peng, *et al.*, "Experimental Automatic Lateral Control System for an Automobile," PATH Report No. UCB-ITS-PRR-92-11, 1992.
12. H. Pham, "A Differential Magnetic Marker Sensing Algorithm: As used in the 1996 Honda Accord AHS Vehicles: Final Report," PATH Draft Research Report, Report No. D98-011, 1998.

13. A. Steinfeld and H.-S. Tan, "Preliminary Findings for a Lane-Keeping and Collision-Warning Driver Interface for Snowplow Operations," PATH Working Paper, Report No. UCB-ITS-PWP-99-6, 1999.
14. G. Stone, "PATH Magnets to Guide AHMCT's Advanced Snowplow for Caltrans," in *Intellimotion*, 1998.
15. Y. Takimoto and M. Kotaki, "Automotive Anticollision Radar," *Applied Microwave*, (Fall) 1992.
16. H.-S. Tan and B. Bougler, "A Snowplow Steering Guidance System using Roadway Markers - Problem Formulation and Solution Concept," *Vehicle System Dynamics*, **32**(1), p. 3-22, 1999.
17. H.-S. Tan, J. Guldner, S. Patwardhan, C. Chen, and B. Bougler, "Development of an Automated Steering Vehicle Based on Roadway Magnets - A Case Study of Mechatronic System Design," *IEEE/ASME Transactions on Mechatronics*, **4**(3), p. 258-272, 1999.
18. D. Tufano, "Automotive HUDs: The Overlooked Safety Issues," *Human Factors*, **39**(2), p. 303-311, 1997.
19. Western Regional Climate Center, "Fort Valley, Arizona - Climate Summary (023160), near Flagstaff, Arizona, 1909 - 1999," [www.wrcc.dri.edu/cgi-bin/cliMAIN.pl?azftva](http://www.wrcc.dri.edu/cgi-bin/cliMAIN.pl?azftva), 1999.
20. J.Y. Wong, *Theory of Ground Vehicles*. 2nd ed. 1993, New York: Wiley.
21. H. Yoo, D. Hunter, and P. Green, "Automotive Collision Warning Effectiveness: A Simulator Comparison of Text vs. Icons," The University of Michigan Transportation Research Institute Report No. UMTRI-96-29, 1996.
22. W.-B. Zhang, R.E. Parsons, and T.H. West, "Intelligent Roadway Reference System for Vehicle Lateral Guidance and Control," United States Patent Number 5347456, Sept. 13, 1994.
23. W.-B. Zhang, H.-S. Tan, A. Steinfeld, B. Bougler, D. Empey, K. Zhou, and M. Tomizuka, "Implementing Advanced Vehicle Control and Safety Systems (AVCSS) for Highway Maintenance Operations," to appear in *Sixth Annual World Congress on Intelligent Transportation Systems*, 1999. Toronto, Canada.



## APPENDIX A

### INTERVIEW PROGRAM

#### **Background Information:**

1. How long have you been driving a snowplow? How would you rate your level of expertise (1 being novice and 10 being an expert)? Does your job title reflect your level of expertise?
2. Approximately how many hours of service have you accumulated in the automated snowplow?
3. Did you feel the training you received adequately prepared you for operating the automated snowplow? If no, please describe any aspects of the system that you felt unprepared to use or that gave you trouble.

#### **General Satisfaction with the AVCS Technologies in the Automated Snowplow:**

1. On a scale of 1 to 10 with 1 being very difficult and 10 being very easy, how would you rate the automated system in terms of ease of use?
2. On a scale of 1 to 10 with 1 being not beneficial and 10 being very beneficial, how would you rate the automated system in terms of increasing your safety?
3. On a scale of 1 to 10 with 1 being not helpful and 10 being very helpful, how would you rate the automated system in terms of increasing the efficiency of your snow removal tasks?

#### **Assessment of Driver Assistance Functions:**

##### Lane Position Indication:

1. Did this feature in any way increase your perceived level of safety?
2. Did you worry less about your position on the roadway? Was your position in the roadway a concern to you in conventional snowplows? How frequently did you glance at the lane position indicator to adjust your travel path?
3. Did this feature in any way increase your operational efficiency? Were you able to increase your speed when plowing? Did you have fewer lane departures? Did you have to make fewer erratic maneuvers?
4. Under what conditions was this feature most helpful? (Daylight vs. darkness? Low visibility vs. high visibility? Snow accumulations of what depth? Roadway geometry or alignment features?)

##### Lane Departure Warning:

1. How often did you use this feature?
2. Did this feature in any way increase your perceived level of safety? Did you worry less about running off the roadway or into other lanes of traffic?

3. Did this feature in any way increase your operational efficiency? Were you able to increase your speed when plowing?
4. Under what conditions was this feature most helpful? (Daylight vs. darkness? Low visibility vs. high visibility? Snow accumulations of what depth? Roadway geometry or alignment features?)
5. Overall, did this feature cause you to become annoyed? Was there a point at which you felt you were ignoring the system?

Collision Warning System:

1. Did this feature in any way increase your perceived level of safety? Did you worry less about colliding with other vehicles or objects?
2. Did this feature in any way increase your operational efficiency? Were you able to increase your speed when plowing? Did you have to make fewer avoidance maneuvers?
3. Under what conditions was this feature most helpful? (Daylight vs. darkness? Situations of reduced visibility? Roadway geometry or alignment features?)
4. Overall, did this feature cause you to become annoyed? Was there a point at which you felt you were ignoring the system?

Human/Machine Interface:

1. Was the lane position and warning information presented in a manner that was easy to read?
2. Was the information presented with enough time to let you make corrective or evasive maneuvers?
3. Did the system provide enough information? Too much...too little?

**System Failures or Human Error and Possible Recommendations:**

1. Did anything fail during your operation of the prototype vehicle? Please explain the nature of the malfunctions and their frequency of occurrence.
2. Did the system ever lead you to make an inappropriate maneuver or error in judgment?
3. Are there any suggestions or recommendations you could make that would increase any of the feature's usefulness or benefit to you?

## APPENDIX B

### ARIZONA SURVEY ADVANCED SNOWPLOW EVALUATION QUESTIONNAIRE

#### Arizona Demo

We would like to ask you some questions regarding your opinion of the driver assist system. We will not be recording your identity and this information will not be associated with you or be used as a means of evaluating your performance. We are only interested in evaluating the system. We may share this with Caltrans/Arizona DOT.

Your participation is voluntary. You are free to refuse to take part. You may refuse to answer any question and may stop taking part in the study at any time. Whether or not you participate in this research will have no bearing on your standing in your job.

**How long have you been driving snowplows?** \_\_\_\_\_

**For the following questions, please circle your choice:**

1) How easy is the system to use overall?

(Very easy) 1      2      3      4      5 (Not easy at all)

2) How much do you like the system overall?

(A lot) 1      2      3      4      5 (Not at all)

3) If you had more time to practice with the system, would you like it more?

(Yes) 1      2      3      4      5 (No)

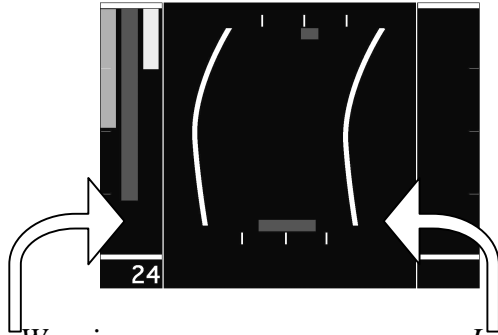
How long do you think you would need to become comfortable with this system?

\_\_\_\_\_

Please answer the questions on the back/next page.

---

**For each component (Collision Warning, Lane Keeping):**



*Collision Warning*

*Lane Keeping*

How easy is this component to use?

How easy is this component to use?

(Very easy) 1 2 3 4 5 (Not easy at all)

(Very easy) 1 2 3 4 5 (Not easy at all)

How much do you like this component?

How much do you like this component?

(A lot) 1 2 3 4 5 (Not at all)

(A lot) 1 2 3 4 5 (Not at all)

Comments:

Comments:

---

**Please draw what you feel would be an ideal display:**

APPENDIX C

ARIZONA MAGNET INSTALLATION TESTS\*

IVI / SNOWPLOW GUIDANCE

RESEARCH PROJECT No. 473

MEMORANDUM

DATE: July 28, 1998  
TO: File  
FROM: Steve Owen  
SUBJECT: MAGNET TEST SITE INSPECTIONS

With the help of the Kingman, Flagstaff and Holbrook Districts, the ATRC carried out a formal inspection on July 14<sup>th</sup> of the six magnet test sites along the I-40 Corridor.

The inspections were initiated at 7 AM west of Seligman, and were completed at Holbrook by 2 PM. Weather was clear, and temperatures ranged from 60 degrees at 7 AM to 90-plus degrees by 2 PM.

Test Site Location	Milepost	Direction	Pavement	Hot RPM Adhesive (Black)	3m Loop-Sealant (Gray)	Silicone Sealant (Tan)
Anvil Rock	110 - I-40	WB	Asphalt	7	7	N/A
Seligman	121 - I-40	EB	Asphalt	8	8	N/A
Garland Prairie	168 - I-40	EB	Asphalt	N/A	9	7
Flagstaff	202.2 - US 66	EB	Concrete	4	5	3
Winslow	249 - I-40	EB	Asphalt	8	8	N/A
Holbrook	279 - I-40	EB	Asphalt	8	8	N/A
Totals				35	43	10

---

\* This appendix is based on an Arizona Transportation Research Center (ATRC) file memo. This material was graciously provided by Steve Owen, manager of research in Intelligent Transportation Systems and Vehicles topics for the ATRC.

### General Results

In all cases the magnets were still in place in the drilled holes. The condition of the sealant varied with the location and with the pavement temperature, as described below.

In all cases, after six months there was no significant chipping, spalling or cracking visible in the pavement where the drilling had been done.

### Results By Site

- MP 110 WB – All of the RPM sealant was intact, but somewhat soft and spongy. Some RPM seals showed a quantity of silica sand on and in the seal material. Most of the gray 3M loop-sealant was firm to the touch, but two holes were somewhat spongy.
- MP 121 EB - All of the RPM sealant was intact, but soft. The 3M sealant was intact, and all but one was firm to the touch.
- MP 168 EB - All of the gray 3M sealant was intact, and solid. All of the tan silicone sealant was also intact and solid.
- MP 202.2 - All of the 3M loop-sealant was intact and solid. All of the RPM adhesive was very soft, and some tearing was evident on two of the holes. The silicone sealant had been previously observed to have formed a skin rather than a seal; those skins had failed and had filled with cinders.
- MP 249 EB - All of the 3M loop-sealant was intact and solid. All of the RPM sealant was intact, but very soft and sticky from the heat.
- MP 279 EB - All of the 3M loop-sealant was intact and solid. All of the RPM sealant was intact, but very soft and sticky from the heat.

### Conclusions & Recommendations

- **Hot RPM Adhesive** - This material when heated flows well around the magnets to seal them in place. It was quick to cure firmly in cold weather, but in hot weather it has become very soft and sticky. This could lead to traffic damage. It also requires a dedicated truck to properly place the material, and needs special care and precision to avoid over-filling the small magnet holes. It therefore is suitable but will have long-term stability concerns.
- **3M Loop-Sealant** - This material was slow to cure in cold weather but it did cure solid eventually. The sealant forms a firm cap over the magnet even in hot weather. The installers say it does flow well and seals the magnets effectively, and it is easy to apply small quantities with a caulking gun. This material should have less waste during installation. It may be somewhat more expensive than the hot sealant, but the labor and equipment needed are less. Based on the inspections, this material appears to be the most suitable and the most efficient.

- **Silicone Sealant** - This material was not available in sufficient quantities for valid testing. It performed well on I-40 at Garland Prairie, but it failed at the only other site tested, on Old US 66 in concrete. It may be that existing fine cracking in the concrete allowed the material to bleed out. The characteristics of the concrete, poor cleaning of the holes, and expired product life also may have degraded the seals. It appears that not enough was learned about this material to support its use in large-scale installations.

This testing program for magnets and installation materials has, after six months, produced fairly clear results. There are some problems at individual sites that may be due to weather conditions during the installation, as well as to the crew's learning curve for the installation process. Also, the installers noted difficulties with some of the materials including expired shelf life dates and related workability problems.

Effective training can minimize these problems, as well as using fresh material, and installing in better weather. Overall, the magnets are all intact and the pavement remains sound after six months. There should be no physical result of these tests that would prevent ADOT from proceeding to the full-scale installation at the US 180 test site.

#### Acknowledgements\*

All of the lane closures were set by the local maintenance forces without any problems or delays, in a very professional manner, and the coordination between the supervisors and their teams worked out very well. This includes Bruce Mejia, Kenny Brooks, Jack Gray, Frances McCauley and their crews, and also the three District Engineers who committed their support to complete this activity.

The desired information was obtained safely and efficiently. The ATRC is very grateful to all those who took part in this inspection program.

---

\* Acknowledgments are for AZ internal memo. ASP project acknowledgments can be found in the report front-matter.