

California AHMCT Program
University of California at Davis
California Department of Transportation

**DEVELOPMENT OF AN ADVANCED SNOWPLOW
DRIVER ASSISTANCE SYSTEM (ASP-II)***

Kin S. Yen¹, Han-Shue Tan², Aaron Steinfeld², Colin H. Thorne¹,
Stephen M. Donecker¹, Bénédicte Bougler², Paul Kretz², Dan Empey²,
Ronald R. Kappesser¹, Hassan Abou Ghaida¹, Mike Jenkinson³,
Stephen R. Owen⁴, Wei-Bin Zhang², Ty A. Lasky¹, and

Bahram Ravani¹, Principal Investigator

AHMCT Research Report
UCD-ARR-00-06-30-02

Final Report of Contract RTA65A0054

June 30, 2000

Affiliations:

1. AHMCT Research Center, Department of Mechanical & Aeronautical Engineering, University of California, Davis, CA 95616-5294
2. California PATH, University of California, Berkeley, 1357 So. 46th St., Richmond, CA 94804-4603
3. Caltrans New Technology & Research Program, P.O. Box 942873, MS 83, Sacramento, CA, 94273-0001
4. Arizona DOT, Arizona Transportation Research Center, 206 S. 17th Ave., MD 075R, Phoenix, AZ 85007

* This report has been prepared in cooperation with the State of California, Business and Transportation Agency, Department of Transportation and is based on work supported by Contract Number RTA 65A0054 through the Advanced Highway Maintenance and Construction Technology Research Center at the University of California at Davis.

Technical Documentation Page

1. Report No. SPR-3 (063)		2. Government Accession No.		3. Recipient's Catalog No.	
4. Title and Subtitle DEVELOPMENT OF AN ADVANCED SNOWPLOW DRIVER ASSISTANCE SYSTEM (ASP-II)				5. Report Date June 30, 2000	
				6. Performing Organization Code	
7. Author(s): Kin Yen, Han-Shue Tan, Aaron Steinfeld, Colin Thorne, Steve Donecker Bénédicte Bougler, Paul Kretz, Dan Empey, Ron Kappesser, Hassan Abou Ghaida, Mike Jenkinson, Steve Owen, Wei-Bin Zhang, Ty Lasky, and Bahram Ravani				8. Performing Organization Report No. UCD-ARR-00-06-30-01	
9. Performing Organization Name and Address AHMCT Center UCD Dept of Mechanical & Aeronautical Engineering Davis, California 95616-5294				10. Work Unit No. (TRAIS)	
				11. Contract or Grant RTA 65A0054	
12. Sponsoring Agency Name and Address California Department of Transportation P.O. Box 942873, MS#83 Sacramento, CA 94273-0001				13. Type of Report and Period Covered Final Report July 1999 - June 2000	
				14. Sponsoring Agency Code	
15. Supplementary Notes					
16. Abstract This final report documents the Advanced Highway Maintenance and Construction Technology (AHMCT) Research Center's Phase Two development of the Advanced Snowplow (ASP), titled "Development of an Advanced Snowplow Driver Assistance System (ASP-II)." This work applies Intelligent Vehicle (IV) and Advanced Vehicle Control and Safety Systems (AVCSS) technologies to enhance the safety and efficiency of snow removal. The system developed includes lane position indication and lane departure warning, as well as a forward collision warning system. The technology has been integrated onto a Caltrans 10-wheel 10-yard plow, and tested through the Winter of 1999 – 2000 in the California Advanced Winter Maintenance Testbed on Interstate 80 near Donner Summit. The system was also tested for three weeks at a similar site on US 180 near Flagstaff, Arizona. The report provides motivation including a brief history of the previous phase (ASP-I), system overview, major subsystems, and functions. It also describes the Human-Machine Interface (HMI), the magnetic sensing system, and the radar-based Collision Warning System (CWS) in detail. The report also discusses improvements made based on findings from the Phase I research, as well as evaluation, conclusions, and future research.					
17. Key Words Intelligent Vehicle, driver assistance, ACMS, AVCSS, human-machine interface, HMI, radar, lateral guidance, maintenance			18. Distribution Statement No restrictions. This document is available to the public through the National Technical Information Service, Springfield, Virginia 22161.		
20. Security Classif. (of this report) Unclassified		20. Security Classif. (of this page) Unclassified		21. No. of Pages 101	22. Price

ABSTRACT

This final report documents the Advanced Highway Maintenance and Construction Technology (AHMCT) Research Center's Phase Two development of the Advanced Snowplow (ASP), titled "Development of an Advanced Snowplow Driver Assistance System (ASP-II)." This work applies Intelligent Vehicle (IV) and Advanced Vehicle Control and Safety Systems (AVCSS) technologies to enhance the safety and efficiency of snow removal. The system developed includes lane position indication and lane departure warning, as well as a forward collision warning system. The technology has been integrated onto a Caltrans 10-wheel 10-yard plow, and tested through the Winter of 1999 – 2000 in the California Advanced Winter Maintenance Testbed on Interstate 80 near Donner Summit. The system was also tested for three weeks at a similar site on US 180 near Flagstaff, Arizona. The report provides motivation including a brief history of the previous phase (ASP-I), system overview, major subsystems, and functions. It also describes the Human-Machine Interface (HMI), the magnetic sensing system, and the radar-based Collision Warning System (CWS) in detail. The report also discusses improvements made based on findings from the Phase I research, as well as evaluation, conclusions, and future research.

EXECUTIVE SUMMARY

Project Overview

Winter maintenance operations, including snow removal, are subject to increased risk. Snowplows must operate in the worst of conditions, including completely covered roads, very low traction, and complete visual whiteout. In addition, in California and other states, the consequences of road run-off are more severe due to the mountainous terrain. Additional danger comes from hidden objects covered in snow, and improper visual cues resulting from previous plowing. The operating environment and the nature of the risks indicates a significant opportunity to enhance the safety of the maintenance operator and the traveling public through the appropriate application of near-term Advanced Vehicle Control and Safety Systems (AVCSS) and Intelligent Vehicle (IV) technologies. Under a Phase One Advanced Snowplow (ASP-I) program, the Advanced Highway Maintenance and Construction Technology (AHMCT) Center at the University of California - Davis (UCD) developed driver assistance, in the form of lane position indication and forward collision warning to increase the safety of the snowplow operation. AHMCT performed this work in conjunction with its partners, the California Partners for Advanced Transit and Highways (PATH) of the University of California at Berkeley (UCB), and the Western Transportation Institute (WTI) of Montana State University (MSU). The California State Department of Transportation (Caltrans) and its research partner, the Arizona DOT (ADOT), both provided test sites and snowplow operators. The DOT operators proved to be invaluable resources, not only for testing the system, but for providing input and guidance throughout the development phase as well. Lateral reference information was based on the California Partners for Advanced Transit and Highways (PATH) discrete magnetic reference marker technology, while forward collision warning was based on a millimeter wave radar sensor system developed by at AHMCT. The efforts of this research team allowed deployment of ASP-I into Caltrans' maintenance fleet in just over half a year's time [31].

Based on the accomplishments of the ASP-I program, the US Department of Transportation's Intelligent Vehicle Initiative (IVI) Specialty Vehicle Partnership (now known as the IVI Infrastructure Consortium) funded continued development of the Advanced Snowplow Driver Assistance system with this Phase Two Program (ASP-II). The objectives of the ASP-II project were to further develop functions for the snowplow guidance system in order to provide a more rugged and functional system for deployment testing, to develop an enhanced Human-Machine Interface (HMI) for snowplow guidance, and to develop quantitative Measures of Effectiveness (MOEs) to allow comparison of results for Winter Maintenance research. The purpose of these MOEs is to ensure that individual Winter Maintenance research projects are responsive to the broader goals of the IVI Specialty Vehicle Partnership and the IVI Specialty Vehicle Platform with the U.S. DOT IVI program.

The ASP-II technical team consists of the AHMCT Research Center and the California PATH program. Caltrans is the lead organization on the study, and has provided test site infrastructure as well as input from snowplow operators and equipment personnel. Caltrans' partner in the study, the Arizona DOT, has provided a second (more rural) test site, access to their snowplow operators, and valuable feedback on the operation of the system. The system was successfully tested through the Winter of 1999-2000. Operators at California's Donner Pass test site used the system regularly from December 1999 until the end of the snow season. In addition,

the system was tested for approximately three weeks at the Arizona test site. Operator feedback has been quite positive.

Summary of Conclusions

The Phase II Advanced Snowplow (ASP-II) was deployed to the Caltrans maintenance fleet in December, 1999. Caltrans operators used it on a regular basis through the winter of 1999-2000, sometimes continually for several days straight during periods of intense storm activity. Additional testing occurred in our partner state, Arizona, on US 180 near Flagstaff. Research engineers continued to analyze and improve the performance of the system, as well performing minor preventive and responsive maintenance on the system, throughout the season's testing. Data regarding operator use of the system was collected during ride-alongs by the research team. Analysis of this data was presented in Chapter 5; indications are positive.

Qualitatively, the survey results presented in Chapter 5 indicate an increase in the level of comfort with the ASP system relative to Phase I results. Specifically, the fraction of drivers indicating that achieving comfort would take less than three days shifted from about half to about three quarters. With respect to the Collision Warning System, qualitative operator survey response was lower, due in large part to the presence of extraneous warnings on high-curvature rural roads. Reduction of such false warnings is being addressed in follow-on research. Due to the limited number of available data collection runs under the ASP-II study, definitive judgment on the full merits of the system must be deferred for a future study, as discussed below.

It is clear that the ASP-II HMI has the potential to be quite beneficial to driver safety and confidence. Quantitative findings suggest that, even with limited instruction, the interface was intuitive and easy to learn. Most drivers were observed to reach a stable level of performance after driving the ASP-II for one Donner Summit run or less (about four miles). Anecdotal comments and experimenter observations also suggested that the display could easily be used either for reference or as a primary driving mechanism.

Based upon analyses of objective data, the system appears to allow drivers to more consistently maintain a stable position near the lane center. Small drops in performance for speed and steering wheel standard deviation while the system was on do not appear to have substantial functional relevance even though there were statistically significant differences. As such, driving with the system appears to be quantifiably similar, if not slightly better, than unaided driving. In addition, note that the comparisons between "display on" and "display off" were made under less than whiteout conditions. Under whiteout conditions, the display will allow plowing operation to continue in situations where it would not be safe to plow without such a device; this was the primary motivation and goal of the ASP development.

The results of ASP-II demonstrate the safety and efficiency that can be obtained through judicious application of Intelligent Vehicle technologies for a maintenance vehicle operating in a harsh and hazardous environment. Under whiteout conditions, the system eases the workload of the snowplow operator, while simultaneously enhancing the safety and efficiency of the operation. This concept is applicable across the Special Vehicle category (maintenance, police, fire, and emergency medical), where operators must perform their duties in all conditions in order to ensure public safety and availability of facilities. Appropriate care must be taken in

extending results from snowplow-based work into other vehicle types, particularly with respect to intended use and human factors issues. However, in the long term, there are no foreseeable limitations to the application of the ASP concept, i.e. it appears to be applicable across all vehicle platforms, including light vehicles, commercial vehicles, and transit vehicles, under the appropriate operating conditions.

Based on the results for Phase I and Phase II testing, as well as strong interest from several State DOTs, the system concept as embodied in the ASP-II research prototype is a viable launching point for future commercialization. The AHMCT center is investigating methods to transition the system from a research prototype to a state that is ready for a private entity to adopt and provide as a commercial product. In addition to hardware and software revisions, the research team recognizes the need for more detailed testing, data collection, and analysis to support this conclusion; such work is occurring under the follow-on RoadView project. From a technical feasibility standpoint, the concept of driver assistance for snowplow operators has been proven as effective in terms of enhancing safety, and desirable from the operator's point of view. In addition, the technology has been shown to be field-ready through two winter's testing in some of the harshest snow environments in the lower 48 United States. Clearly, ASP-II is a second-generation research prototype, and improvements are needed in terms of manufacturability, further robustness, packaging, cost, etc. However, the research team is committed to continued efforts to enhance the state of the system, and to work with commercial entities to ensure that this valuable addition to the winter maintenance arsenal is transitioned smoothly from a research prototype to a commercially available system.

Summary of Future Research and Development

While the system as embodied in the ASP-II prototype vehicle is now ready for transition to detailed commercialization, there are a number of open questions that can be pursued in future research and development.

Additional field-testing data should be collected to further document the performance, reliability, and user acceptance of the ASP technology. Such a study will significantly enhance the ability of a commercial entity to assess the potential costs and benefits of the system. AHMCT, PATH, and WTI are initiating a project known as "A Rural Field Test of the RoadView™ System."

The ASP-II CWS is a great improvement over that in ASP-I. However, there are a number of areas where continued research and development is needed. The CWS system must be made more universal, so that the same system that works well in a six-lane divided interstate will also perform well on a two-lane rural highway. In addition, the system will require multiple sensor integration (e.g. inertial, magnets, steering sensing) and algorithmic improvements to reduce false alarm rates, as well as to improve redundancy and fault tolerance. AHMCT researchers are currently developing algorithms and software to address these issues for curved road sections.

As part of the commercialization process, improvements can be made in the in-vehicle sensing systems. Significant steps have been made in this regard by AHMCT, with the development of an Intelligent Sensing Architecture, currently targeted for sensing of discrete magnetic markers, i.e. as a replacement for the existing sensing system in ASP-II. This

intelligent system provides numerous advantages over the existing technology. All data transmission is digital, so that electronic noise is eliminated and cabling requirements are vastly reduced. The resulting system is more robust and maintainable, while simultaneously being an order of magnitude cheaper. Sensing algorithm modifications can be made so that the system can provide key information over a wide range of speed, all the way down to zero velocity, thus facilitating use in other operations, such as low-speed bus docking. The signal processing algorithm can be extended to support both discrete and continuous magnetic reference marker systems. In addition, the processing unit can be extended to encompass other aspects of the in-vehicle system, ultimately leading to a “black box” that could be easily retrofitted in an existing vehicle, e.g. in the snowplow cab, allowing a commercial entity to develop a feasible after-market kit. Research and development on this sensing system is continuing at AHMCT, and early versions of the system are currently being considered for commercialization.

The ASP program has applied discrete magnetic marker based lateral sensing and forward collision warning to provide driver assistance, thus keeping the driver in the loop and allowing deployment of these technologies on public roadways in mixed traffic in a safe manner. The technologies employed in ASP clearly evolved from earlier full vehicle control work, such as that performed under the NAHSC program. Thus, application of these technologies for full automation in appropriate winter maintenance tasks is a reasonable next step. One such project currently in progress is the “Development of the Advanced Rotary Plow (ARP) for Snow Removal Operations,” a pooled fund study, led by Caltrans, with participation by the Alaska, Nevada, and Utah DOTs. This project will include full lateral control, along with forward obstacle detection. Application of precision lateral control for the blower will reduce or eliminate contact with the guardrail, while also improving the repeatability and accuracy of the work performed. Collision hazards are introduced by the presence of natural objects, such as large rocks and debris, as well as abandoned vehicles. Obstacle detection technology will provide added safety, as well as reduced DOT liability and repair costs. The combination of automatic vehicle control and obstacle detection is referred to as the Advanced Rotary Plow, or ARP.

Finally, as similar work is occurring in other states, it is critical to continue to develop methods of quantitatively comparing research results in an unbiased manner. As part of ASP-II, California and Minnesota have developed initial cooperative quantitative Measures of Effectiveness (MOEs), which can dictate the needs for future data collection and analysis. As the California project is now ending, and the Minnesota project is just starting, there was unfortunately little overlap in the initial development of these MOEs. However, with continuing work in these areas under the RoadView and other programs, the ASP program will continue to refine MOEs, and continue to work in a cooperative fashion in this development with Minnesota as their project progresses. As the systems being developed have some significant differences with respect to technology and overall approach, it is critical that these MOEs are developed in a way that isolates these differences, and allows for a fair and unbiased comparison of the systems. A draft MOE document is provided in Appendix A. This is considered a living document, and will be revised through future cooperative efforts between the California and Minnesota researchers.

TABLE OF CONTENTS

<i>Abstract</i>	<i>iii</i>
<i>Executive Summary</i>	<i>v</i>
Project Overview	v
Summary of Conclusions	vi
Summary of Future Research and Development	vii
<i>Table of Contents</i>	<i>ix</i>
<i>List of Figures</i>	<i>xi</i>
<i>List of Tables</i>	<i>xiii</i>
<i>Disclaimer/Disclosure</i>	<i>xv</i>
<i>List of Acronyms and Abbreviations</i>	<i>xvii</i>
<i>Acknowledgments</i>	<i>xix</i>
<i>Chapter One</i>	<i>1</i>
<i>Introduction</i>	<i>1</i>
Motivation	1
Project Overview	3
System Cost	5
Test Site Infrastructure	5
Report Overview	6
<i>Chapter Two</i>	<i>9</i>
<i>System Overview</i>	<i>9</i>
Lateral Sensing	9
Collision Warning System	11
Human-Machine Interface	13
Current System Status	14
<i>Chapter Three</i>	<i>15</i>
<i>ASP-II System Hardware</i>	<i>15</i>
<i>Chapter Four</i>	<i>25</i>
<i>Software Architecture</i>	<i>25</i>
Magnetic Sensing System Process	26
Database Process	27
Radar Driver Processes	28
Radar Target Sorter Process	29
Encoder Process	30
Display Process	31
<i>Chapter Five</i>	<i>33</i>
<i>Refinement of the ASP HMI</i>	<i>33</i>
HMI Design Changes from ASP-I	33

Arizona Findings	35
California Findings	38
Overall HMI Conclusions.....	43
Chapter Six	45
<i>Magnetic Sensing System.....</i>	45
Introduction	45
Magnetic Marker Model.....	46
Noise Effects.....	46
Magnetic Sensing Algorithm.....	47
Signal Processing Algorithm	51
Link between Magnet Sensing and HMI	52
ASP-II Lessons Learned for Magnetic Sensing System.....	54
Chapter Seven.....	57
<i>Collision Warning System.....</i>	57
Sensing Requirements.....	57
Sensing Technologies	57
Research and Findings from ASP-I.....	58
Research and Findings from ASP-II	59
Development of the Advanced CWS	59
False Warning Suppression Software (FWSS).....	61
Vehicle and Computer Interface.....	63
Chapter Eight	65
<i>Conclusions and Future Research</i>	65
Conclusions	65
Future Research and Development	66
References.....	69
Appendix A	73
<i>Draft Cooperative Measures of Effectiveness</i>	73
Appendix B	77
<i>ASP Evaluation Questionnaire.....</i>	77

LIST OF FIGURES

Figure 1-1: ASP-II during Testing near US 180 at Flagstaff Arizona.....	4
Figure 2-1: System Call-Out for the Advanced Snowplow, with Key Subsystems.....	9
Figure 3-1: Equipment Location Layout Schematic.....	15
Figure 3-2: ASP-II Industrial Computer Chassis.....	16
Figure 3-3: System Power and Reset Switches.....	17
Figure 3-4: System Layout, including LCD Panel for HMI.....	18
Figure 3-5: Absolute Encoder for Steering Wheel Angle Sensing.....	19
Figure 3-6: EVT-300 Dual Radar Mount.....	19
Figure 3-7: Magnetometer Sensor Array.....	21
Figure 3-8: Custom Sensor I/O Board, Top View.....	22
Figure 3-9: Side View of Sensor I/O Boards.....	22
Figure 3-10: ASP Power Supply System.....	23
Figure 3-11: LCD Diagnostic Screen.....	24
Figure 4-1: System Processes.....	25
Figure 4-2: Magnetic Sensing Software Process Diagram.....	27
Figure 4-3: Database Process Diagram.....	28
Figure 4-4: Radar Driver Process Diagram.....	29
Figure 4-5: Radar Target Sorter Process Diagram.....	30
Figure 4-6: Encoder Process Diagram.....	31
Figure 4-7: Screen Shot of the In-Vehicle Display.....	31
Figure 4-8: Display Process Diagram.....	32
Figure 5-1: ASP-II HMI characteristics.....	33
Figure 5-2: HMI and other Equipment Positioning.....	35
Figure 5-3: Comparison of Estimated Time for Comfort between ASP-I and ASP-II.....	37
Figure 5-4: Learning Performance under Sanding Conditions.....	39
Figure 5-5: Lateral Displacement Performance.....	41
Figure 5-6: Speed Performance.....	41
Figure 5-7: Steering Wheel Standard Deviation Performance.....	42
Figure 5-8: Lateral Displacement when Plowing by Road Segment.....	43
Figure 6-1: Snowplow Front Right Side (including Center) Magnetic Tables.....	50
Figure 6-2: Snowplow Front Left Side (including Center) Magnetic Tables.....	51
Figure 6-3: “Peak-Mapping” Magnetometer Signal Processing Block Diagram.....	52
Figure 6-4: The Lane Positioning Assistance Display.....	53
Figure 7-1: Plow Stopping Distance for 0.1 g Deceleration and 1.0 Second Reaction Time.....	58
Figure 7-2: Diagram of Area Covered by the Dual EVT-300 CWS.....	60
Figure 7-3: Diagram of Situation Capable of Generating a False Collision Warning.....	61
Figure 7-4: Diagram of Road Curvature Coordinate Transformations for False Warning Suppression.....	63

LIST OF TABLES

Table 5-1: Survey Results for ASP-II.....	36
Table 5-2: Testing Conditions.....	40

DISCLAIMER/DISCLOSURE

The research reported herein was performed as part of the Advanced Highway Maintenance and Construction Technology (AHMCT) Research Center, within the Department of Mechanical and Aeronautical Engineering at the University of California, Davis and the New Technology and Research Program at the California Department of Transportation. It is evolutionary and voluntary. It is a cooperative venture of local, state and federal governments and universities.

The contents of this report reflect the views of the author(s) who is (are) responsible for the facts and the accuracy of the data presented herein. The contents do not necessarily reflect the official views or policies of the State of California, the Federal Highway Administration, or the University of California. This report does not constitute a standard, specification, or regulation.

LIST OF ACRONYMS AND ABBREVIATIONS

Acronym	Definition
ACMS	Advanced Construction and Maintenance Systems
ADOT	Arizona Department of Transportation
AHMCT	Advanced Highway Maintenance and Construction Technology
APS	Applied Physics Systems
ASP	Advanced Snowplow
ASP-II	Advanced Snowplow, Phase II
ATRC	Arizona Transportation Research Center
AVCSS	Advanced Vehicle Control and Safety Systems
AWMT	Advanced Winter Maintenance Testbed
Caltrans	California State Department of Transportation
CWS	Collision Warning System
DGPS	Differential Global Positioning System
DOT	Department of Transportation
EMI	Electromagnetic Interference
FLD	Front Lateral Displacement
GPS	Global Positioning System
HMI	Human-Machine Interface
HUD	Head-Up Display
ISTEA	Intermodal Surface Transportation Efficiency Act of 1991
I-80	Interstate 80
ITS	Intelligent Transportation Systems
ITSA	Intelligent Transportation Society of America
IV	Intelligent Vehicle
IVI	Intelligent Vehicle Initiative
LCD	Liquid Crystal Display
LD	Lateral Displacement
LIDAR	Light Detecting and Ranging
MMW	Millimeter Wave
MOE	Measure of Effectiveness
MP	Milepost
MSU	Montana State University
NAHSC	National Automated Highway Systems Consortium
PATH	Partners for Advanced Transit and Highways
RF	Radio Frequency
RFI	Radio Frequency Interference
RPM	Raised Pavement Marker
RTOS	Real-Time Operating System
SBC	Single Board Computer
UCB	University of California at Berkeley
UCD	University of California-Davis
VA	Vehicle-to-Road Angle
WTI	Western Transportation Institute

ACKNOWLEDGMENTS

The authors thank the California State Department of Transportation and the US Department of Transportation Federal Highway Administration's Intelligent Vehicle Initiative (IVI) Specialty Vehicle Partnership for their support. In addition, the authors thank the Arizona State Department of Transportation and its staff for their participation and cooperation in this research effort. The authors would also like to acknowledge the dedicated efforts of the AHMCT ASP-II development team, as well as those of AHMCT's research partners at Caltrans, ADOT, and PATH, without whom this work would not have been possible. In addition, the researchers would like to thank the Caltrans Equipment Service Center and Caltrans Maintenance for their invaluable support. Finally, the authors would like to thank the Sierra Snowfighters at the Kingvale Maintenance Center for their insight, interest, and hospitality.

CHAPTER ONE

INTRODUCTION

This report documents the Advanced Highway Maintenance and Construction Technology (AHMCT) Research Center's Phase Two development of the Advanced Snowplow (ASP), titled "Development of an Advanced Snowplow Driver Assistance System (ASP-II)." Throughout this report, the vehicle and the project will be referred to as ASP-II, with context indicating which. Items specific to the Phase One project or vehicle will be referred to by ASP-I, while items germane to both projects will be referred to by ASP. The document provides motivation including a brief history of ASP-I, system overview, major subsystems, and functions. It also describes the Human-Machine Interface (HMI), the magnetic sensing system, and the radar-based Collision Warning System (CWS) in detail. Finally, it provides conclusions and recommendations for future research. Appendices provide further detail on the hardware and software of ASP-II, as well as the questionnaire form used to obtain operator feedback.

Motivation

Winter maintenance operations, including snow removal, are subject to increased risk. Snowplows must operate in the worst of conditions, including completely covered roads, very low traction, and complete visual whiteout. In addition, in California and other states, the consequences of road run-off are more severe due to the mountainous terrain in which much of the snow removal operations must be performed. Additional danger comes from hidden objects covered in snow, and improper visual cues resulting from previous plowing. The operating environment and the nature of the risks indicates a significant opportunity to enhance the safety of the maintenance operator and the traveling public through the appropriate application of near-term Advanced Vehicle Control and Safety Systems (AVCSS) and Intelligent Vehicle (IV) technologies. Under the Phase One Advanced Snowplow (ASP-I) program, the Advanced Highway Maintenance and Construction Technology (AHMCT) Center at the University of California - Davis (UCD) developed driver assistance, in the form of lane position indication and forward collision warning to increase the safety of the snowplow operation. AHMCT performed this work in conjunction with its partners, the California Partners for Advanced Transit and Highways (PATH) of the University of California at Berkeley (UCB), and the Western Transportation Institute (WTI) of Montana State University (MSU). The California State Department of Transportation (Caltrans) and its research partner, the Arizona DOT (ADOT), both provided test sites and snowplow operators. The DOT operators proved to be invaluable resources, not only for testing the system, but for providing input and guidance throughout the development phase as well. The efforts of this research team allowed deployment of ASP-I into Caltrans' maintenance fleet in just over half a year's time [31].

Researchers at the AHMCT Center, as well as our research partners at Caltrans, have long considered the benefits of providing guidance information and/or control to enhance winter maintenance activities. The ASP Driver Assistance System clearly demonstrates the near-term benefits of AVCSS technologies in general, and for winter maintenance in particular. The main goal of the on-going ASP program is to assist the snowplow operator in safely and efficiently performing snow removal. A subsidiary goal is the demonstration of the beneficial near-term

application of AVCSS and IV technologies for maintenance operations. A guiding principle for the development of the ASP system has been the use of relatively low-cost, commercially available components, with lateral sensing provided by infrastructure-embedded elements for maximum reliability, and display imagery developed in a hardware-independent fashion to allow for future advances in display technology or cost reduction. The ASP-I system was tested successfully through the winter of 1998 – 1999 in both California and Arizona. After hardware and software improvements made during the beginning of the ASP-II project, the ASP Driver Assistance System was field-tested in Caltrans' Advanced Winter Maintenance Testbed (AWMT) on Interstate 80 near Donner Summit, during the 1999 – 2000 season. ASP-II was also tested for approximately three weeks at Arizona's test site on US 180 in Kendrick Park, near Flagstaff.

Based on the accomplishments of the ASP-I program, the US Department of Transportation's Intelligent Vehicle Initiative (IVI) Specialty Vehicle Partnership (now known as the IVI Infrastructure Consortium) funded continued development of the Advanced Snowplow Driver Assistance system with this Phase Two Program (ASP-II). The objectives of the ASP-II project were:

- to further develop functions for the snowplow guidance system in order to provide a more rugged and functional system for deployment testing,
- to develop an enhanced Human-Machine Interface (HMI) for snowplow guidance,
- and to develop quantitative Measures of Effectiveness (MOEs) to allow comparison of results for Winter Maintenance research. The purpose of these MOEs is to ensure that individual Winter Maintenance research projects are responsive to the broader goals of the IVI Specialty Vehicle Partnership and the IVI Specialty Vehicle Platform with the U.S. DOT IVI program. A draft MOE document is provided in Appendix A. This is considered a living document, and will be revised through future cooperative efforts between the California and Minnesota researchers.

The IVI Specialty Vehicle Partnership funded two studies, which were intended to run concurrently, investigating various approaches to enhance safety of snowplowing operations. The ASP-II study, documented in this report, uses a cooperative vehicle-infrastructure system to provide high reliability and robustness for lateral vehicle position sensing. The Minnesota study uses a GPS-based approach to provide lateral sensing, removing the need for additional roadway infrastructure. This approach does require a detailed, high-accuracy, GIS database for the roadway and surrounding infrastructure, a high-accuracy GPS receiver in the vehicle, and GPS base stations and radio links, including FCC licenses unless using spread spectrum, for differential corrections. With respect to collision warning, the ASP-II project provides full three-lane coverage with two-dimensional position sensing ahead of the vehicle, while the Minnesota study provides forward and rear collision warning augmented by GPS and GIS to reduce nuisance and false alarms. Further details of the Minnesota study will be available in the University of Minnesota final report for that project, anticipated in the Summer of 2001.

Currently, no independent third party evaluation or comparison of the two systems has been performed. Clearly, this would be of great interest to the two research teams, as well as the IVI

Specialty Vehicle Partnership. However, such an evaluation was outside of the scope of the two funded research projects.

The ASP-II technical team consists of the AHMCT Research Center and the California PATH program. Caltrans is the lead organization on the study, and has provided test site infrastructure as well as input from snowplow operators and equipment personnel. Caltrans' partner in the study, the Arizona DOT, has provided a second (more rural) test site, access to their snowplow operators, and valuable feedback on the operation of the system.

The ASP-II system provides significant improvements over the state of the system as of the completion of the ASP Phase One study (ASP-I). Technical improvements included a complete redesign of the magnetometer sensor enclosure and mount system, as well as improvements to the electronics enclosure. This was the main source of hardware trouble (environmental intrusion) during ASP-I; no failures occurred for these systems under ASP-II. Connector hardware was also greatly improved; the only failure that occurred in this area under ASP-II was due to a vendor-provided connector on the EVT-300 radar. This issue has been resolved. The switch to EVT-300 radar has enabled full two-dimensional mapping of obstacles, so that the system can now provide obstacle location tied to lane position, as discussed in the HMI and radar chapters. In addition, the use of dual EVT-300 sensors provides complete three-lane coverage at close range ahead of the plow, which is critical for plows with either a right or left-side wingplow. Full two-dimensional radar information, along with lateral position data, yaw rate, and steering angle, enables detailed false warning suppression for future systems. Under ASP-II, the research team has begun investigation of such a system; full testing and implementation will occur under follow-on studies. Additional improvements include augmented HMI display information including landmarks to provide absolute location, and further robustness enhancements to the magnetic sensing system.

The first (ASP-I) and second (ASP-II) generation research prototype vehicle has now been through two full winters of field-testing and operation. The first winter provided a proof-of-concept for the system, and indicated areas of the system that required redesign. The ASP-II program has addressed these issues, and the resulting system was tested through the winter of 1999 – 2000. Detailed data collection was performed through both winters, as documented in the current report, as well as the Phase One report [31]. However, the research team recognizes the need for more detailed testing, data reduction, and analysis; such a study is planned in a follow-on project known as “A Rural Field Test of the RoadView System,” which will instrument two additional plows with the RoadView technology (Advanced Snowplow technology as of the end of the Phase Two effort), and perform detailed field test and evaluation over two winters.

Project Overview

The ASP system functions include lane position indication, lane departure warning, and forward collision warning. Lane position indication and lane departure warning were developed by PATH using their embedded magnetic reference marker system for lateral position indication within the lane. Feasibility of this technology was shown at the National Automated Highway Systems Consortium (NAHSC) 1997 Demonstration; the technology is robust and well-suited for the current application. The Collision Warning System (CWS) was developed by AHMCT, using a millimeter wave radar system, which performs well in the snow environment; this system

detects vehicles and other inorganic objects buried or obscured by snow. The ASP-I CWS was based on the Commercial-Off-The-Shelf (COTS) Eaton Vorad EVT-200 sensor, which provided range and rate to targets, and supported serial communication via the RS-232 standard. The ASP-II CWS was vastly improved through use of a pair of front-mounted EVT-300 sensors, which provide higher quality range and rate information, in addition to azimuth angle to multiple targets. Dual radars allowed full coverage of three lanes ahead of the plow (useful when using left or right-mounted wingplow), and azimuth angle data allows the system to map detected obstacles to their lateral location, i.e. the system can inform the driver in which lane the obstacle is located. AHMCT and PATH jointly developed the Human-Machine Interface (HMI). AHMCT integrated all subsystems on the snowplow, including numerous improvements in hardware (sensor enclosures and mounts, cabling connections, and electronics enclosures), documented in detail in Chapter 3. The overall system architecture used on the ASP is based on an open architecture, so that other sensors and subsystems can be incorporated in the future. Caltrans provided the snowplow. The ASP-II, re-deployed into operation in December 1999, can be seen in Figure 1-1, during testing in Arizona. The dual radar system can be seen mounted in front of the grill, above the snowplow blade.



Figure 1-1: ASP-II during Testing near US 180 at Flagstaff Arizona

Caltrans snowplow operators tested the system in storm conditions starting early in December 1999. Feedback from the operators is very positive. The Caltrans operators were involved with the design of the system, particularly the HMI, from early in the Phase One project. Arizona operators also tested the system for about three weeks in February 2000, and also provided very helpful feedback. CA and AZ DOT operators and managers continue to provide valuable feedback, and the research team continues to improve the system based on

these suggestions. The rapid deployment of this system into operation in a maintenance fleet represents an early success in the application of Intelligent Vehicle and AVCSS technologies for Specialty Vehicles.

System Cost

The cost for equipment and labor to develop the ASP prototype vehicle is estimated at approximately \$60,000. Based on foreseen revisions in hardware and installation approaches, the current estimate for a volume production unit is in the range of \$20,000 - \$30,000. Cost of infrastructure installation for the test sites was approximately \$25,000 per mile, including surveying, installation, and magnets. The cost is evenly divided between surveying and mechanical installation of the magnets. For pending installations, contractor cost is estimated at \$18,000 per lane mile. AHMCT is conducting a technical feasibility study of automation of the mechanical installation process for the discrete magnets. If automation of the process is feasible, work crew reductions may be achieved. In one example installation, a work crew of eight performed the mechanical installation. With automation, the crew may be reduced to two, with both crew members safely contained within the support vehicle. Detailed investigation is needed regarding equipment cost amortization, number of anticipated installations, manpower costs, automation production rate, and resulting lane closure time. As such, projections for cost reduction, if any, would be preliminary at this time.

Test Site Infrastructure

ASP-II was field-tested in Caltrans' Advanced Winter Maintenance Testbed (AWMT) on Interstate 80 near Donner Summit over the winter of 1999-2000. It was also tested for approximately three weeks at Arizona's test site on US 180 in Kendrick Park, near Flagstaff, Arizona. Magnets were installed at both sites in the summer of 1998. Additional test sections are anticipated in California (9.7 km, or six miles, in 2000), Arizona (closed their loop in 1999, as noted below), and other states.

During the summer of 1998, Caltrans developed a test corridor for field-testing and demonstration of ASP-I. This AWMT, located on Interstate 80 in Nevada County near Donner Summit, currently has approximately 6.3 km (3.9 miles) of lane two (three-lane road) instrumented with the discrete magnetic marker system. The test track is at a high elevation (1,950 – 2,190 m, or 6,400 – 7,200 ft) and records large snow accumulations (as much as 16.5 m (54 ft) of snowfall a season with roadside accumulations reaching 6 m (20 ft) high). Whiteouts are common due to blowing wind and the sheer volume of snow. The stretch of road instrumented with magnets is a divided, restricted-access highway with three lanes and wide shoulders traveling uphill and west between the Donner Lake (milepost (MP) Nev-9.1) and Castle Peak (MP Nev-5.1) interchanges. The test route starts about halfway up the northern slope of the Donner Lake valley and ends at the pass summit on the west end of the valley. The entire site is located in mountainous terrain, with steep grades and many curves. The location was selected because this portion of I-80 typically closes before other sections of the road due to weather patterns and has a relatively high vehicle per hour traffic count. This corridor will be extended westward by an additional 3.2 km (2 miles) in the summer of 2000, with future infrastructure installations planned over the next few years to allow longer test runs, as well as

testing of other advanced winter maintenance vehicles currently being considered. Future infrastructure installations will be timed with scheduled roadway maintenance.

Arizona's test site, located on a stretch of US 180, consists of a two-lane undivided rural mountain road, with frequent whiteouts due to high winds. This installation includes areas of relatively high curvature and steep grades. In the summer of 1999, Arizona installed an additional 3.2 km (2 miles) of infrastructure, resulting in a complete closed-loop test track. The site currently represents a total of approximately 9.7 km (6 miles) within Kendrick Park, located about 32 km (20 miles) northwest of Flagstaff, Arizona. This instrumented test-site is situated at roughly 2440 m (8000 ft) in elevation and runs northward from MP 235.0 to MP 238.0 and southward from MP 238.0 to MP 235.0. The northbound 4.8 km (3.0 mile) segment begins in forest, continues through an open, windswept valley and ends with a winding eight percent downgrade. The southbound 4.8 km (3.0 mile) segment reverses the course, closing the loop. This location receives frequent snowfall and is often exposed to winds of varying force, resulting in whiteout conditions and drifting. The designated road segment is in a relatively high traffic area because it is the shortest route from Flagstaff to Grand Canyon National Park.

Report Overview

The remainder of the report provides details of the ASP-II system, subsystems, and testing. Particular emphasis and detail is provided for the HMI, as this system is the most relevant to the end user.

Chapter 2 provides a more detailed overview of the ASP-II system architecture, as well as preliminary details on the main subsystems, namely, the lateral positioning system, the collision warning system, and the human-machine interface. Subsequent chapters provide further detail of these subsystems.

Chapter 3 provides detailed information and photos of the hardware installation on ASP-II. This includes the sensing systems for both lateral positioning and for obstacle detection. It also includes the in-cab display and controls. Finally, it includes the computing, power electronics, and miscellaneous support subsystems for the vehicle.

Chapter 4 documents the software architecture used in ASP-II. The architecture is based on a set of independent processes that communicate through a shared database process. The system is based on the QNX Real-Time Operating System (RTOS).

Chapter 5 provides a detailed discussion of the ASP-II human-machine interface (HMI). This is the most critical aspect of the ASP, as it is the one means of presenting the driver assistance information to the operator. The chapter discusses the requirements of the operation and the goals for the interface, mini-studies used to develop the display imagery (including detailed testing results), and the display imagery itself. Some discussion of operator impressions is also provided, along with results from 1999-2000 winter's testing, including data collected. Chapter 5 also presents the results of the Cooperative Measures of Effectiveness development.

Chapter 6 discusses the magnetic sensing system. This system provides the lateral position information needed to show the operator the current vehicle position. In addition, as the system

allows coding of roadway curvature, with the combination of a steering wheel encoder, the magnetic sensing can also provide critical predictor information to the operator, i.e. it provides a representation of both current and future vehicle location. The chapter provides an overview of the magnetic marker model, noise effects, and the sensing and signal processing algorithms used.

Chapter 7 discusses the radar system used in the Collision Warning System. This chapter provides a review of the sensing requirements, along with an overview of the COTS hardware used, i.e. the EVT-300 radar system. False warning suppression issues and techniques are also discussed, along with some detail on the interface between the ASP-II computer and the EVT-300 sensors. Finally, the chapter presents challenges encountered in the current development, and envisioned hardware and algorithmic changes to address these challenges in future phase research.

Chapter 8 provides conclusions, lessons learned, and recommendations for future work. Appendix material provides more detailed documentation of cooperative MOE development and survey material.

CHAPTER TWO

SYSTEM OVERVIEW

The ASP-II system technology has been integrated onto a Caltrans nose/wing plow vehicle, based on an International Paystar 5000 platform. Original integration of the technologies occurred under the ASP-I program; under ASP-II, many systems were updated for improved performance and robustness. This chapter provides a brief description of the main subsystems of the ASP-II: the Lateral Sensing System, the Collision Warning System, and the Human-Machine Interface, all shown in Figure 2-1. Other support subsystems, e.g. computing and power, are discussed in detail in Chapter 3. The software architecture used to implement all ASP-II functions is discussed in Chapter 4.

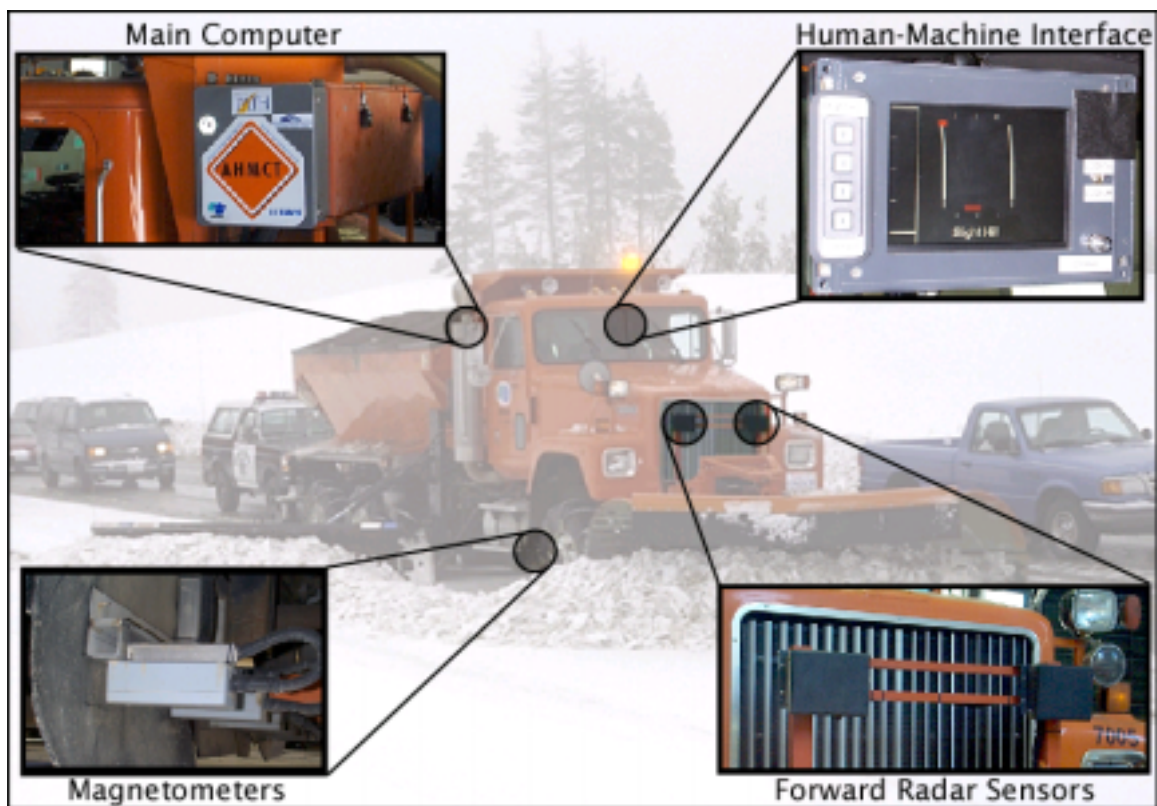

Figure 2-1: System Call-Out for the Advanced Snowplow, with Key Subsystems

Lateral Sensing

Snowplow operating conditions such as poor road delineation, obscured pavement, reduced visibility due to rain and snowstorm, low temperature, and mountainous roads are a significant factor in the choice of technologies for lateral sensing. There are several well-developed technologies for vehicle lateral guidance for AHS. They may be classified as vision-based, roadway reference system based, and radio wave signal based methods. Vision-based systems are generally considered inappropriate in poor visibility conditions such as fog, rain, and particularly snow. GPS-based sensing is one form of radio method. As part of the current study,

initial feasibility tests have been performed to determine whether a GPS-based approach is reliable in the rural mountainous environments considered in this study. A GPS base station has been established in the Donner test area, and initial GPS readings and radio link tests have been performed. Results for this work are too preliminary to support a conclusion at this time, and the researchers will continue this investigation under ongoing projects. The research team selected a roadway reference based approach, rather than autonomous sensing, such as a vision system, in order to provide the required sensing reliability and robustness [32].

Roadway reference systems include induction wires, radar-reflective tape, magnetic tape [11], and discrete reference markers [14]. Reference system elements may be passive or active. Example markers include magnets, colored paint marks, retroreflective raised pavement markers, and radar-reflective materials. Any optic-based marker detection system faces the same problem as any other vision-based system in a snow removal environment; as such, these systems are not feasible here. In addition, marker technologies that are at the pavement level or higher are subject to removal by the plowing operation. At Donner Summit, the painted lane markings are usually completely scraped off by the end of the winter season, often much more quickly. PATH experiments using embedded magnetic markers for lateral control have shown a maximum lateral sensing error of 1.5 cm with 1 cm standard deviation [17]. Similar results are documented in recent precision docking experiments [22]. This is well within the 3 cm requirement. Discrete magnetic markers embedded in the roadway can be used for longitudinal position measurement as well as lateral control. Moreover, magnetic markers can be coded with other roadway information by flipping polarities, which each vehicle can read via onboard magnetometers. Magnetic pavement marker tape has been shown to have similar performance [11] for lateral position measurement; however, at this time, it cannot be coded to provide roadway information, and the material appears to be quite expensive relative to magnets; however, installation costs are currently lower for magnetic tape, resulting in comparable overall cost. In addition, the discrete magnetic marker approach provides excellent accuracy, with lateral error generally less than 1.0 cm [22]. Regarding accuracy of the magnetic tape system [16], field tests of magnetic tape on a snowplow show “measured position relative to the actual position ranged from plus or minus six inches when the detector was centered on the tape to about one inch when the center of the detector was between one foot and 30 inches from the tape.” However, according to [1], the combined magnetic tape and sensing system can achieve “ ± 1 cm above the tape and ± 5 cm at ± 90 cm (± 2 in. at ± 3.1 ft.) from the center of the tape at speeds from 8-40 kph (5-25 mph) (validated in laboratory tests). Based on the maturity and robustness of the discrete magnetic marker technology, it was selected for use in the current study.

Under the ASP-I program, magnets were installed along a four-mile stretch of Interstate 80 (I-80) near Donner Summit, in California. The magnets are installed in the center of lane two of this three-lane stretch of divided road. This provides the sensing needed to guide the lead plow of a snowplow platoon or echelon formation during whiteout conditions, and in cases where the roadway is completely obscured by ground snow. Once the lead plow has made its pass along the roadway, the remaining plows can use its windrow (snowdrift) as a visual guide. During the summer of 1998, Arizona installed an additional test site on US 180 in Kendrick Park, north of Flagstaff, Arizona. This installation is along a rural, two-lane highway, with areas of relatively high curvature, and very high winds.

The ASP is instrumented with an array of seven magnetometers located near the front axle of the vehicle. Three magnetometers on front are sufficient for an automatically steered vehicle, while five are deemed necessary with manual driving to allow for human error. In addition, operators often drive with an offset from lane center on the order of 0.6 m (2 ft), which leads to a need for an extra magnetometer on either end of the array, providing a total range of approximately ± 1 m, sufficient to support offset driving. At any given time, three magnetometers are considered active, and an algorithm decides when to shift the active magnetometers based on field strength. PATH has modified its existing sensing algorithms used for automatic vehicle control to meet the specific needs of the ASP-II. Under ASP-I, the system used both front and rear magnetometer arrays, thus doubling the installation effort and cost; early in ASP-II, it was determined that for snowplow operating speeds, the front magnetometer provides sufficient information. Thus, one significant modification for ASP-II was to change the algorithm so that it determines all needed information from the single array of magnetometers. From the system standpoint, reducing the required magnetometers reduces system cost, complexity, and installation requirements, while simultaneously enhancing system robustness and reliability. The sensing system provides lateral measurement as well as an estimate of the vehicle's heading with respect to the road. Heading angle is output from an estimator, based on the lateral measurement history (moving window), road curvature, steering angle, and a dynamic model of the snowplow. In addition, the binary coding in the magnets provides an index, with which the system can reference an on-board lookup table (or database) to determine milepost, landmark, and curvature information. With this combination of information, along with vehicle steering angle obtained from a steering wheel encoder, the system can display current as well as predicted vehicle location with respect to the road, as well as the upcoming curvature. The HMI that displays this information is discussed below, and in greater detail in Chapter 5. Further detail regarding the lateral sensing can be found in Chapter 6, as well as [33].

Collision Warning System

The adverse operating conditions expected in normal operation, including falling snow, snow coverage, and rain, impact the choice of sensing system for the Collision Warning System (CWS) on the ASP-II. Additional complications arise for obstacle detection due to road curvature in mountainous areas. Snowplows operating in the mountainous roads of California and Arizona, for example, face roads with high curvature, which complicate obstacle detection methods.

There are many sensing methods capable of detecting roadway obstacles. The principle technologies used in current highway automation research include vision, ultrasonic, LIDAR / LASER radar, and millimeter wave (MMW) radar. Several of these technologies can be discounted immediately for the snow environment. Vision-based systems, as well as LIDAR systems, depend on lighting and optical field-of-view, both of which are severely impeded during inclement weather conditions. Ultrasonic sensors are also inadequate in adverse weather conditions. Accuracy of distance measurement is affected not only by wind gusts, but also by rain and snow. Because the speed of sound differs in air, snow, and water, presence of snow or water will induce errors in the distance measurement.

The only viable systems that remain, then, are Laser- and Radar-based. Based on the severity of weather conditions for snowplow operation, including blowing snow from the snow removal

operation itself, radar is the best choice. As laser radar operates in the optical range, it is still adversely affected by snow reflections. Calspan [3] concluded the following:

- MMW radar tends to be more robust in terms of weather than laser techniques,
- MMW radar allows for operation in fog, rain, and falling snow,
- and MMW radar was found to be ‘very effective even in rain as heavy as 10 mm/hr’.

The radar systems used in the Phase II were the Eaton Vorad EVT-300, operating at 24.725 GHz. Past experiments [20] show rain and snow do not significantly deteriorate MMW radar performance operating in this frequency range, even when sensors were covered with thick snow. This agrees with observations in the current project. MMW radar systems are sufficiently accurate for the required range, approximately 100 m for collision detection and warning. MMW radar was tested in snow and near whiteout conditions in Japan, with the system providing sensing out to 110 m [13]. The biggest concern regarding MMW radar in the operating environment is the build-up of thick layers of ice on the radome. This was encountered during the first year’s testing, and did adversely effect sensing. During Phase II development ASP-II standard maintenance was expanded to include routine cleaning of the radome. No further problems occurred in Phase II.

The harsh operating conditions of the snowplow environment demand a ruggedized solution for the CWS. Here, a commercially tested unit was preferred. The Eaton Vorad EVT-300 delivers the accuracy and range necessary for the current application, along with the ruggedness demonstrated through testing of previous generations of radar antennas in commercial vehicle applications. This radar provides range, closing rate, azimuth angle, and quality factor for up to seven targets, increased from the three-target limit of the EVT-200 that was used under ASP-I. In addition, through use of the RS-485 standard, the system can be easily interfaced with the industrial PC used for sensing I/O and processing. In ASP-II, an RS-485 to RS-232 converter is used to interface to the standard serial ports on the industrial computer; in a commercial system, direct support for RS-485 would be more appropriate. With these capabilities, this sensor met the robustness needs in a package that could be integrated onto the vehicle in a relatively short time. The EVT-300 also provides an integrated gyro to measure vehicle yaw rate, which has been incorporated into an algorithm to reduce false alarms on curved sections of roadway.

The ASP-II CWS is a forward CWS, with two antennas mounted symmetrically 0.4 m (1.3 ft) from vehicle centerline, on a specially designed fixture mounted behind the plow blade near the front of the hood. This CWS will alert the operator of obstacles in the direct path of the vehicle, as well as obstacles in lanes to the left and right. For snowplow operations, where a wingplow may be used on either the left or right side of the vehicle, projecting approximately one lane out from the vehicle, it is essential to provide obstacle detection and warning for the lanes adjacent to the plow. The use of two radar antennas provides this range of coverage, which also allows the system to detect oncoming traffic in two-lane rural operations. In addition, the availability of target azimuth data allows the system to determine the lateral location of obstacles, so that they can be presented to the operator in an intuitive manner. The HMI presents information from the CWS in a single coordinated interface, as discussed below and in Chapter 5. Further information on the current ASP-II CWS can be found in Chapter 7.

Human-Machine Interface

From the standpoint of the snowplow operator, the Human-Machine Interface (HMI) represents the entire ASP-II. Methods of sensing vehicle position, obstacle detection, etc., are meaningless to the operator, who will only see the display and react accordingly. Thus, considerable thought was dedicated to the method of presenting this information. Early experiments verified the research team's expectation that the system must provide preview or prediction information to the operator. That is, with a look-down sensing system, it is necessary to project data forward so that the operator has an indication not only of where the vehicle is currently at, but where it is heading in the future. To support this, a steering shaft encoder was added to the system to allow prediction of the future vehicle path. In addition, providing upcoming curvature information allows the driver to determine an approximate steering angle, with minor corrections around this nominal steering angle based on the current and future vehicle locations. The ability to provide prediction is a significant advantage of the magnetic marker-based approach over any strictly look-down (i.e. no prediction) approach, as demonstrated in [25]. In this reference, it was shown that driver performance without prediction exhibited excessive steering oscillations.

The research team investigated available hardware to provide the HMI display for the operator. Initial preference was for a Head-Up Display (HUD), so that any imagery could be presented in the operator's field-of-view, removing the need to look away from the roadway. However, several factors indicated a HUD or similar approach was less than ideal. First, commercially available HUDs that the team could locate do not integrate well into the existing snowplow cab. In fact, many present physical hazards to the operator, as the units must mount very near the operator's head, presenting significant danger in an accident. In addition, there are known perception problems with respect to HUDs, which can lead to misinformation and hazard [19, 27]. With these factors, as well as a preference for a low-cost system for future commercialization, the research team decided to use a Liquid Crystal Display (LCD) panel as the display for the HMI. A guiding principle for ASP system hardware been the use of relatively low-cost, commercially available components, with display imagery developed in a hardware-independent fashion to allow for future advances in display technology or cost reduction.

The LCD is mounted in the location of the vehicle's rear-view mirror; the snowplow used in this study does not have a rear-view mirror, as the rear window is completely obscured by standard snowplow equipment, including the spreader, toolbox, and mounting plates. This location keeps the display out of the way for normal operation, while providing an easy check for the operator in conditions of reduced visibility, e.g. during whiteout conditions. It is a very easy position for the driver to look at, as drivers are accustomed to glancing regularly at the rear-view mirror in a normal vehicle. In addition, this location is obscured by snow and ice that is not removed by the plow's wiper blades. Originally, the display was mounted on top of the dashboard near the driver's right hand. However, one of the drivers suggested moving the display to the rear-view mirror position so that shorter drivers could have a less obstructed view of the right-hand wingplow mirror. Interviews with other drivers revealed that this was a popular design modification. The display is divided into two logical areas. The main region displays lateral driver assistance information, including a representation of the current and upcoming roadway curvature, as well as indicators of current and upcoming vehicle position. The left region displays distances to the closest obstacle for each of the three lanes, using a downward

moving tape display, which also implicitly conveys rate information to the operator. This portion is for the forward CWS radar. The guiding principle for the display is to provide the necessary information to the operator without any unnecessary information clutter, and in a fashion that is relatively independent of the actual display hardware. The system must not distract from the operator's normal attention, and must be adaptable to future hardware developments. For a more detailed view of the HMI hardware in the snowplow cab, see Chapter 3. Further detail on the HMI and its development can be found in Chapter 5, and [18].

Current System Status

The system is based in Caltrans' Kingvale maintenance fleet on Interstate 80 near Donner Summit. Caltrans operators used it on a regular basis through the winter of 1999-2000, sometimes continually for several days straight during periods of intense storm activity. Additional testing occurred in our partner state, Arizona, on US-180 near Flagstaff. Researchers continue to analyze and improve the performance of the system, as well as performing preventive and responsive maintenance on the system. Data regarding operator use of the system continues to be collected during ride-alongs by the research team. Analysis of current data appears in Chapter 5. Throughout both phases of this program, operator feedback has led to continuing improvements in the HMI display, as well as to system hardware. Testing of the system through two complete winters subject to heavy snow under actual field conditions has provided a wealth of information regarding system robustness and need for ruggedization. This information clearly could not have been obtained from lab testing or limited field demonstrations. As discussed in Chapter 8, field-testing, research, development, and commercialization of the technologies proven under ASP-II are proceeding at this time. In addition, these technologies are being applied in other winter maintenance systems, in particular, for full automation of a rotary snowplow.

CHAPTER THREE

ASP-II SYSTEM HARDWARE

The Advanced Snowplow is composed of several tightly integrated subsystems. Commercial-off-the-shelf (COTS) items are employed when possible to reduce both development time and system cost. However, a few subsystems are custom designed and fabricated. The ASP may be segmented into six subsystems: computing unit, human-machine interface (HMI), sensing system, sensor interface electronics, power supply system, and diagnostic system. Nearly all components, except sensors and HMI, are located inside the weather-tight equipment enclosure behind the truck cab, shown in the schematic in Figure 3-1. The ASP-II system was based on the ASP-I system. Several components were added and modified to increase its robustness and data recording capability. Specifically, the following changes were made in system hardware:

- the HMI 10.4” LCD display was replaced with 6.4” High-brightness LCD display,
- a video camera and recorder system was added to support the Measure of Effectiveness (MOE) study,
- the rear set of magnetometers was removed,
- the front magnetometer mount and enclosures were redesigned and manufactured to address the shortcomings of the previous design,
- the gear ratio of the steering shaft to steering angle encoder was decreased,
- two EVT-300 radars replaced the EVT-200 radar,
- a “simulation” switch was added for driver training,
- a 4” LCD display was added at the snowplow passenger side for diagnostic and demonstration purposes.

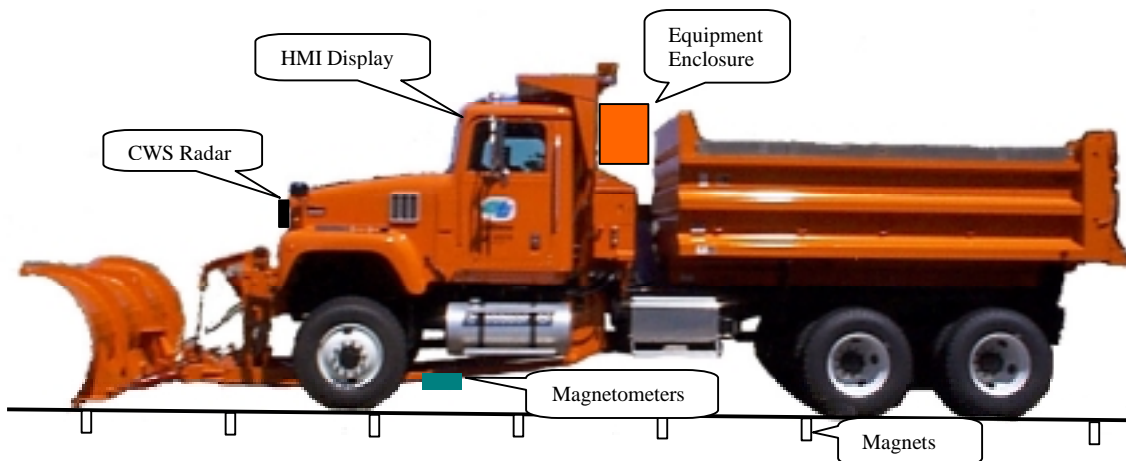

Figure 3-1: Equipment Location Layout Schematic

The computing unit consists of an industrial computer chassis with a passive backplane, an Intel Pentium II 333 MHz single board computer (SBC), two National Instrument I/O cards, a 4-port serial adapter, a Netgear FA310TX 10/100 BaseT Ethernet card with DEC Tulip chipset, and a Quantum 3.8 GB EIDE hard disk. The computer is located at the center of the equipment enclosure under the sensor interface boards. The industrial computer chassis is an IPC-10XP from CyberResearch, Inc., and has a 10-slot passive backplane that can accept five full-length ISA, four PCI, and a PICMG CPU card slot, and requires 110 VAC input. The PICMG SBC has an Intel Pentium II 333 MHz CPU, 128 MB EDO RAM, onboard ATI video with 4MB video RAM, two serial ports, and a PCI EIDE controller. A Quantum Fireball 3.8 GB EIDE hard drive was used to store the QNX 4.24 Operating System, controller software, and diagnostic data. A Quantum hard drive was chosen based on its vibration specifications. A solid-state disk was tested; however, write performance was significantly slower than that of the Quantum drive. In addition, a National Instruments AT-MIO-64E data acquisition board was used to read data from the magnetometers and other analog sensors. Its digital I/O ports were used to read user inputs, such as the “simulation” switch. Furthermore, a National Instrument PTIO-10 timer board was used to interface with the Hall-effect speed sensor on the vehicle transmission; in addition, its digital input ports were used to detect any magnetometer failures. The four-port serial adapter was added to communicate with the radar systems and the steering wheel encoder. Most components were chosen based on device driver support for QNX RTOS. The two National Instrument board device drivers were written by PATH. Other device drivers are available either from QNX or the original manufacturer.

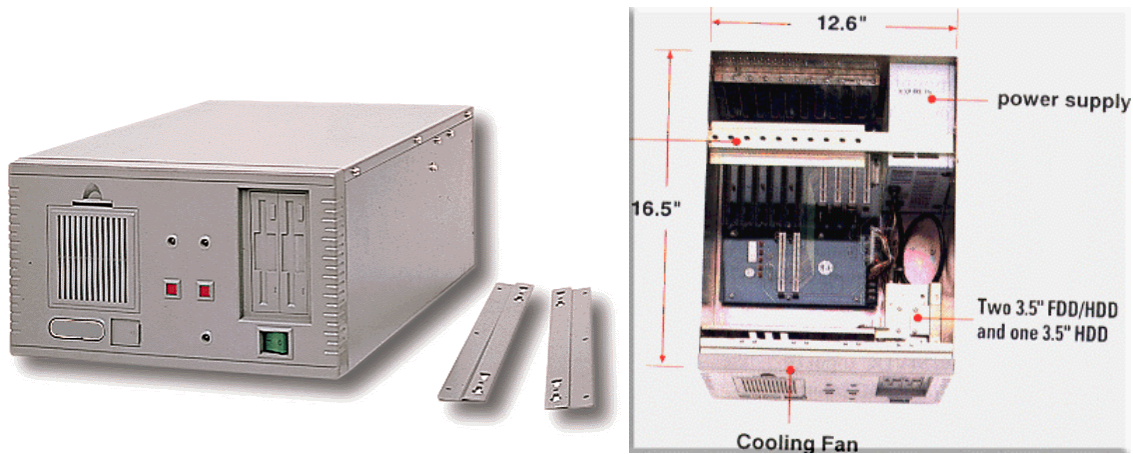

Figure 3-2: ASP-II Industrial Computer Chassis

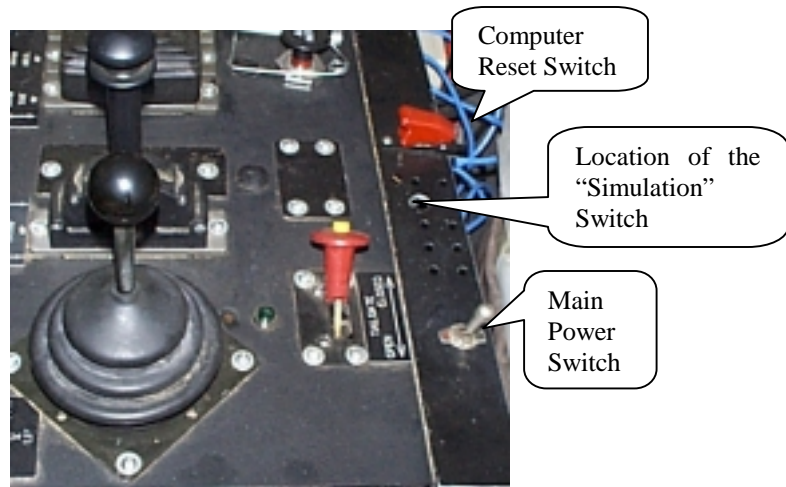

Figure 3-3: System Power and Reset Switches

The HMI system display is an ultra-high brightness 6.4" LCD panel mounted inside the snowplow cab. The HMI also includes three control switches located at the rear end of the center console, illustrated in Figure 3-3: the main power switch for the driver assistance system, the computing unit reset switch, and the "simulation" switch. The computing unit reset switch is a momentary switch with a red safety switch cover to prevent accidental activation. The main power switch located next to the red switch cover is a locking switch; it should be left in the "ON" position so that the driver assistance system will come on whenever the snowplow ignition key is turned. A programmable time-delay circuit was added to turn off the system ten minutes after the ignition is turned off. In addition, a locking "simulation" switch is connected to digital I/O port 2 of the AT-MIO-64E board. The system goes into simulation mode for driver training or static system demonstration when the "simulation" switch is turned on before the system boot up. A close-up view of the LCD is shown at the top of Figure 3-4. The HMI LCD panel, which displays the computer VGA signal, provides 640x480 resolution and a maximum brightness of 900 nit, and requires regulated +5 and +12 VDC power input. The driver may adjust the brightness and contrast by turning a knob or pushing a button attached to the display. A custom enclosure was designed and fabricated to minimize interference with other controls. A black and white video camera was integrated into the enclosure; this camera can provide monitoring of driver glance while the system is in operation. The mount location and hardware are shown at the bottom of Figure 3-4.

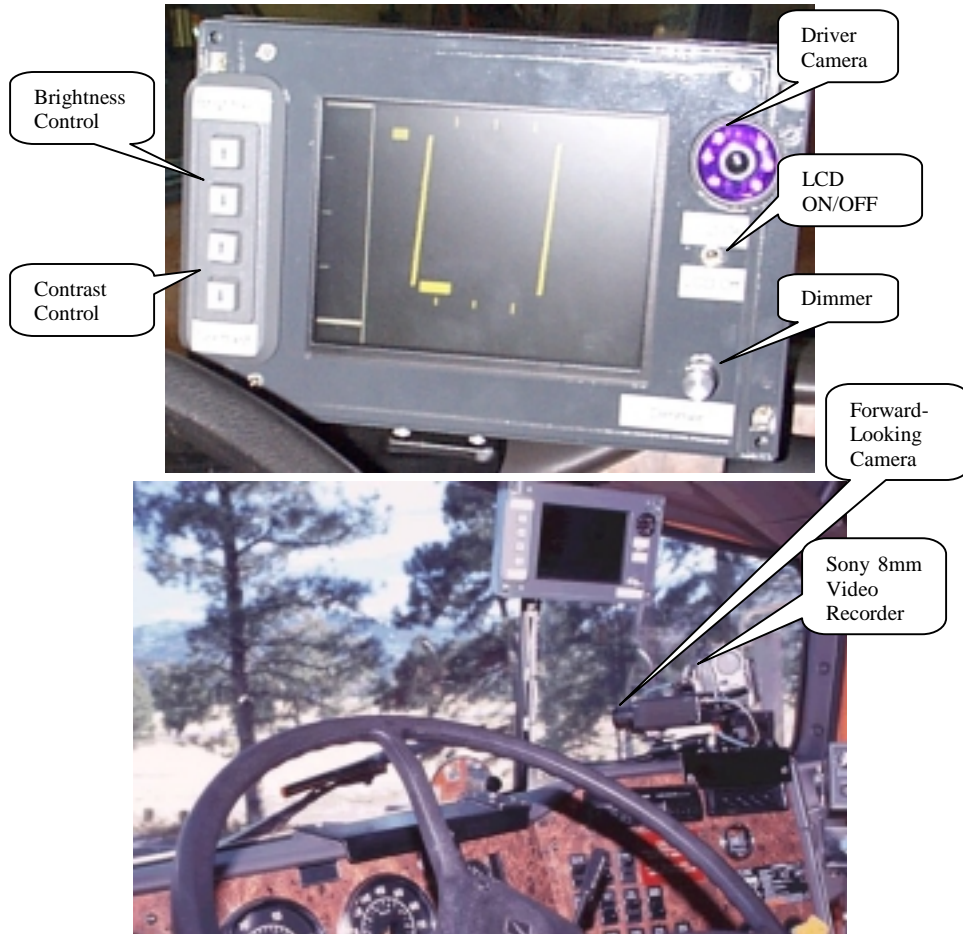

Figure 3-4: System Layout, including LCD Panel for HMI

The sensor system consists of an absolute encoder, two Eaton Vorad EVT-300 radars, and a series of magnetometers for magnetic marker detection. The absolute encoder, shown in Figure 3-5, measures the steering wheel position, used in predicting future vehicle position. It communicates with the computer through an RS-232 serial port and provides steering wheel location at 10 Hz. The encoder has a resolution of 0.1 degree. The steering wheel resolution depends on the gear ratio between the steering wheel and the encoder. The current gear ratio is 13:6, so that the encoder makes one complete turn for every 2.167 steering wheel turns, with resulting resolution of 0.2167 steering wheel degrees per encoder count. The collision warning radar communicates with the computer via two RS-232 serial ports. Each EVT-300 V-Bus signal is converted to RS232 signal via a B&B Electronics 232SAER J1708-to-RS232 converter. Following Eaton Vorad instructions, the 232SAER converter was modified to specification. The two radars are mounted in front of the radiator as shown in Figure 3-6. Further collision warning radar configuration and details are discussed in Chapter 7. Note that there is no direct sensor providing vehicle heading. Instead, heading angle is output from an estimator, based on the lateral measurement history (moving window), road curvature, steering angle, and a dynamic model of the snowplow.

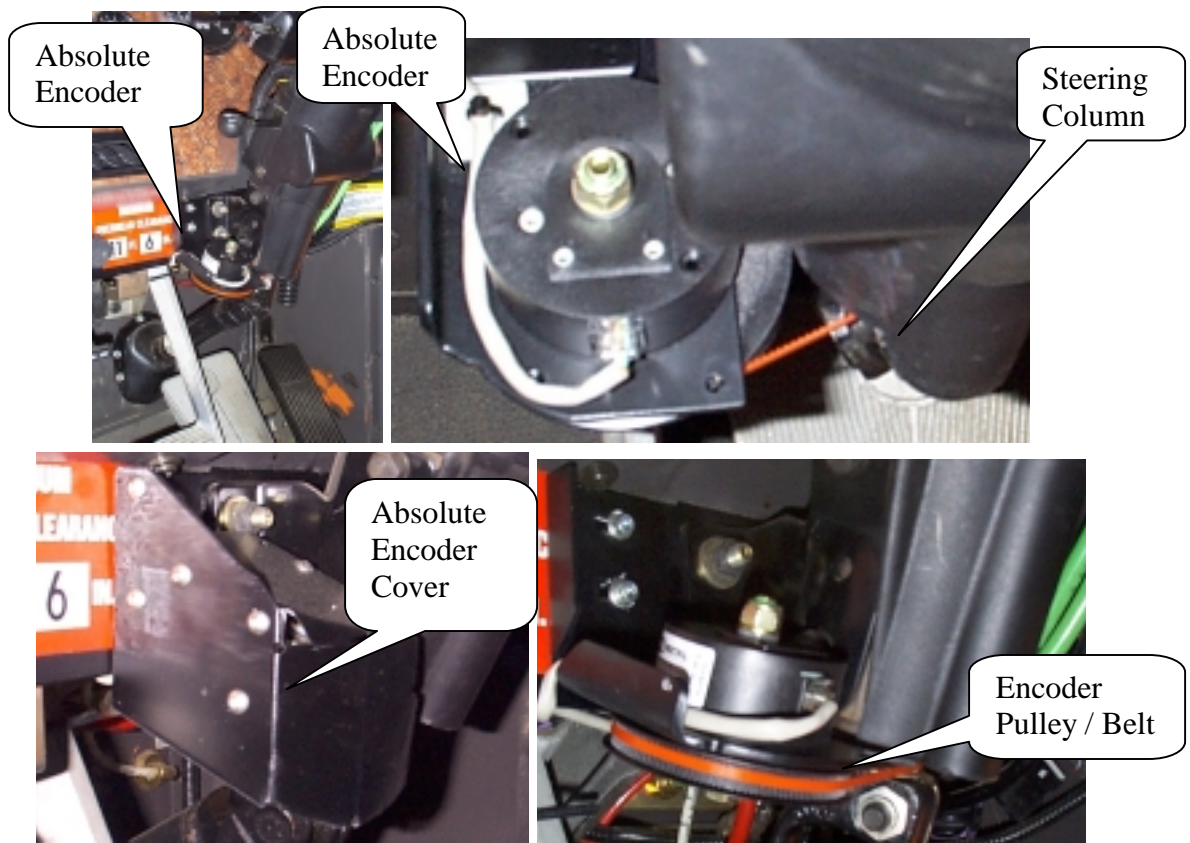

Figure 3-5: Absolute Encoder for Steering Wheel Angle Sensing



Figure 3-6: EVT-300 Dual Radar Mount

The magnetic marker sensor system consists of an array of seven Applied Physics Systems (APS) APS-535 fluxgate magnetometers. The magnetometer bank is mounted behind the front wheels (see Figure 3-7). All magnetometers are about 20 cm (8 in) above the ground. Lowering the sensors would provide a better signal-to-noise ratio; however, the sensors must be high enough so that the rare-earth magnetic markers (used in bridge structures) will not saturate the sensors. The magnetometers are mounted 30 cm (1 ft) apart laterally within each bank, and each has an operating range of +/- 15 cm (5.9 in) from the center of the sensor element. Therefore each bank of magnetometers yields a combined lateral sensing range of +/- 1.05 m (3.4 ft) from the center of the vehicle. The exceptionally large sensing range is required because snowplow operators often drive with up to a 0.6 m (2.0 ft) offset when driving in an echelon snowplow formation. Each magnetometer is encased inside a sealed aluminum enclosure to prevent water damage. A custom internal aluminum mounting plate was designed and fabricated to mount the APS-535 magnetometer inside the enclosure. Each magnetometer output and power cable (Belden 8166) was routed through a nickel-plated brass liquid-tight dome-style cord grip fitting mounted on the seal enclosure. A custom 316 stainless steel magnetometer mount was designed to suspend the sensors in the proper locations. Each magnetometer output channel is connected to the sensor interface board. Extended details on magnetic marker detection and signal processing can be found in Chapter 6 and related reference material.

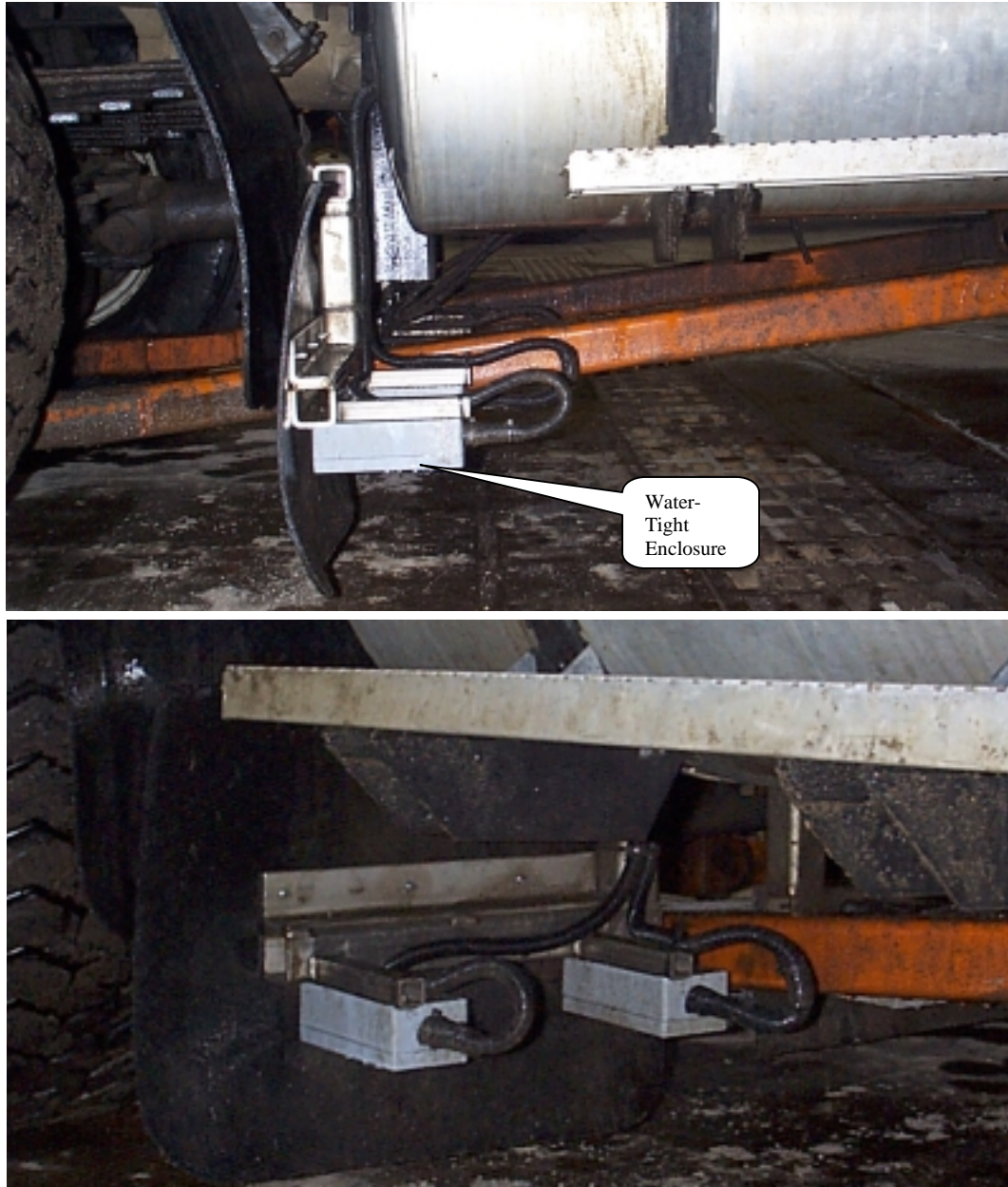

Figure 3-7: Magnetometer Sensor Array

The sensor interface electronics provide signal conditioning for the analog sensor output, as well as overload protection for digital I/O and analog output from the AT-MIO-64E and PTIO-10. The three sensor interface boards, designed by PATH, are located above the computing unit. Each board provides an interface between the sensors and the National Instruments boards. The magnetometer outputs are low-pass filtered with an effective bandwidth of 140 Hz and connected to the upper 48 A/D channels of the AT-MIO-64E. The anti-aliasing filter must be selected rather carefully with the intended application and sampling rate in mind. The present cutoff is only marginally acceptable in the presence of low frequency interference. In addition, the pulse output from the Hall-effect speed sensor at the vehicle transmission is connected to the

PTIO-10 sensor interface board. Revisions to the sensing and interface electronics are being considered in future research, motivated both by the signal processing and physical form-factor.

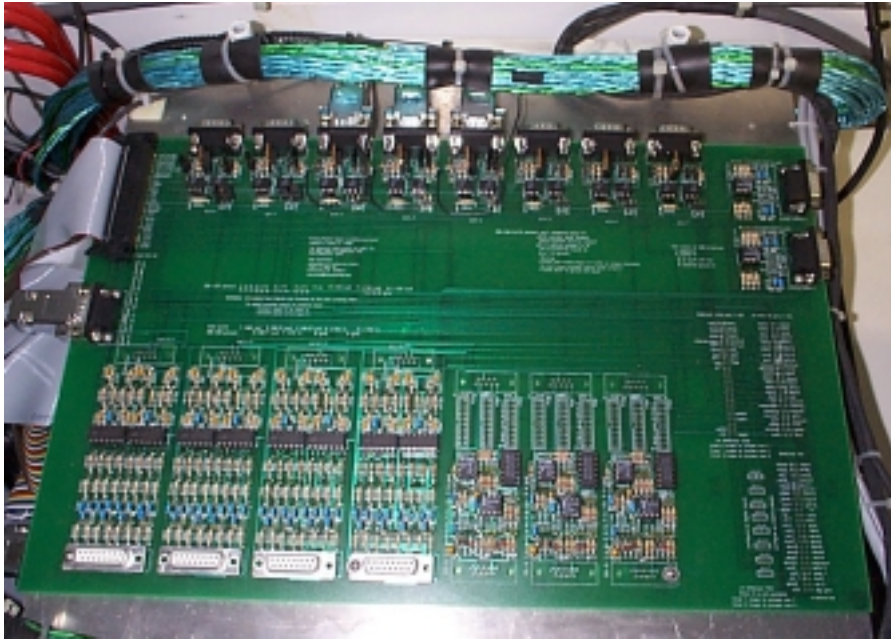

Figure 3-8: Custom Sensor I/O Board, Top View

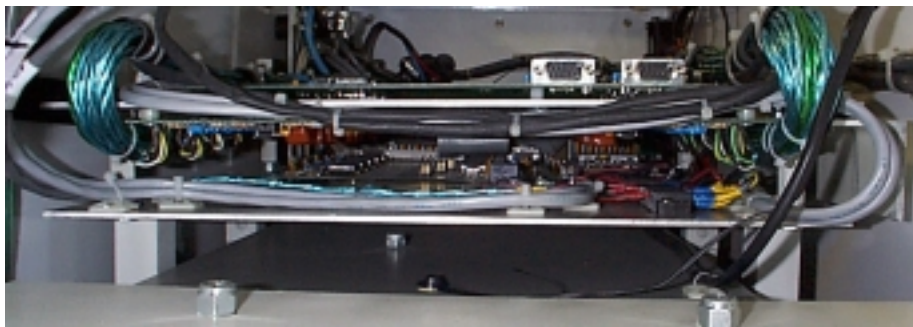

Figure 3-9: Side View of Sensor I/O Boards

The power supply system provides power backup, voltage regulation, power supply conversion, and fuse protection for all components. The subsystem consists of a 110 VAC inverter, a 12 V to ± 15 V DC-DC converter, transformers, backup batteries, switching power supply, relays, and a fuse system. Four 60 Amp-hr sealed gel lead-acid batteries are used for the power backup. Battery backup may be eliminated if the system does not require operating for an extended period of time when the engine is off, i.e. it is only required for a research platform but is not needed for a final production unit. Furthermore, the power system will be more efficient if the inverter is replaced by DC-DC converters. However, this requires detailed investigation of the exact power requirements of each component, and locating the necessary DC-DC converters. A custom-designed power system is required for the final production unit.



Figure 3-10: ASP Power Supply System

Finally, the diagnostic package includes a video system and a laptop computer running the QNX 4.24 operating system. A Toshiba Tecra 740CDT laptop and Linksys EC2T PCMCIA (PC Card) network card were chosen based on QNX compatibility. The diagnostic laptop is not connected during normal operation, and is used only during software updates and system debugging. A video system was added in the ASP-II upgrade. It includes a forward-looking day-night video camera, a B/W low-light “lip-stick” video camera to record the driver, a VGA-to-NTSC converter which converts the VGA computer display signal to NTSC video signal, a color quad processor which combines the three NTSC input signals into one NTSC output signal, a 4” LCD NTSC video monitor, and a Sony CCD-TRV95 8mm video recorder. The 4” LCD NTSC video monitor (shown in Figure 3-11) displays the VGA computer NTSC video signal to the snowplow passenger, supporting both system diagnosis and demonstration. However, it can be connected to any of the other three NTSC video signals as desired. In addition, the researcher may also choose to record any of the four NTSC video signals (forward-looking, driver response, computer display, or combined video) using the Sony 8mm recorder. Sample videos are available at www.ahmct.ucdavis.edu.



Figure 3-11: LCD Diagnostic Screen

CHAPTER FOUR

SOFTWARE ARCHITECTURE

The ASP-II software architecture is driven by the need for real-time operation. The ASP-II travels at speeds up to 13.4 m/s (30 mph), detecting the vehicle's present location, predicting its future location, detecting obstacles in the vehicle's path, and displaying all the information in real-time on a Human-Machine Interface (HMI). Because of the real-time nature of this operation and the volume of computations necessary to evaluate approximately ten magnetic markers per second (~23 markers/sec at 26.8 m/s (60 mph) in a light-vehicle control application) and ten radar messages per second, it is essential that the different program processes that perform these operations do not interfere with each other.

To solve this problem, the software architecture is divided into processes of varying priorities. The magnetic sensing software, which senses the magnets embedded in the roadway and determines the vehicle's present and future locations, is given the highest priority. All other software processes are given lower priorities. The processes are ranked in priority according to the real-time needs of the system. The five processes, shown in the system diagram in Figure 4-1, listed in order of decreasing priority are:

- Magnetic Sensing Software Process
- Database Process
- Two (2) Radar Driver Processes
- Radar Target Sorter Process
- Encoder Process
- Display Process

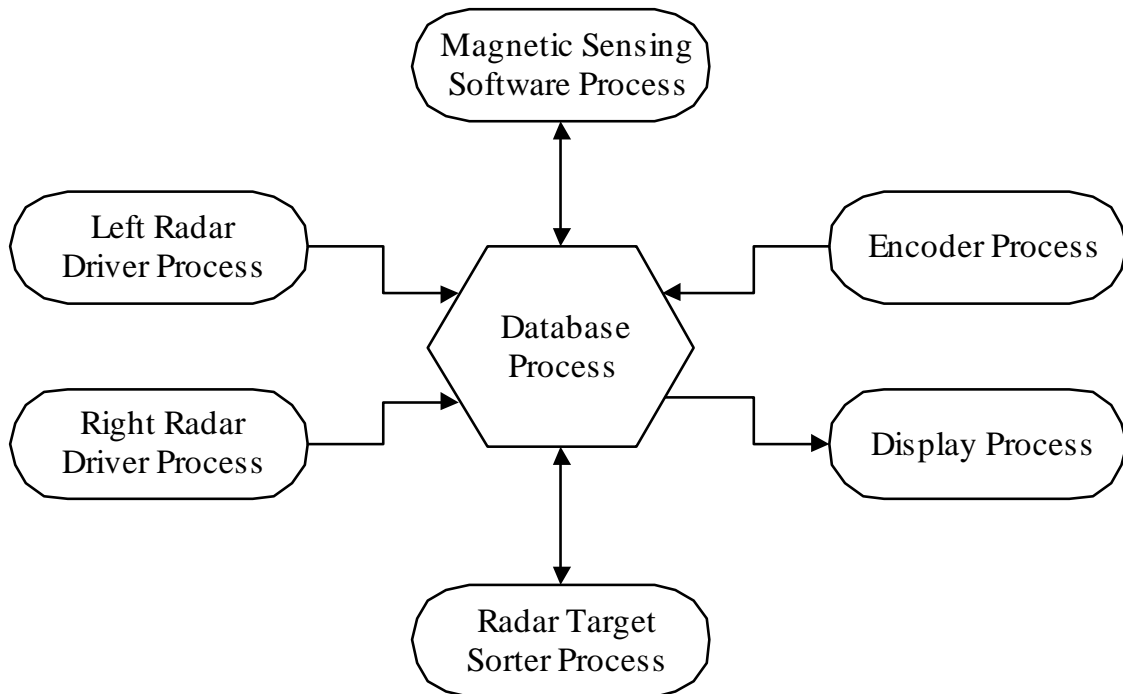

Figure 4-1: System Processes

The priorities were determined based on the importance of the process in maintaining the essential functions of the ASP-II. Although the display is the end-goal of the system, if the underlying processes aren't functioning, the display's information is irrelevant. Therefore, though it may seem paradoxical to give the display the lowest priority, this results in the best information being displayed.

Magnetic Sensing System Process

The Magnetic Sensing System (MSS) process determines the vehicle's current position in the roadway and the vehicle's future location based on current vehicle and roadway data. The MSS determines the vehicle's position on the roadway using data from an array of magnetometers, devices that measure magnetic field strength, as described in Chapter 6. The magnetometer array contains seven magnetometers, evenly spaced and mounted in enclosures located under the ASP-II, behind the front axle.

Magnets are embedded in the highway infrastructure in the center of the lane at 1.2 m spacing. The magnetometers sense the magnets and send signal strength information to the computer. The MSS then determines the vehicle's position relative to the magnets by analyzing the field strength of the magnet on the seven magnetometers. The magnet is located between the two magnetometers with the highest strength readings. The exact location of the ASP-II over the magnets can be determined with very high accuracy based on this method. Chapter 6 provides the details of the magnet signal processing algorithm.

By varying the polarity of the magnets in the roadway (North vs. South pole) the magnets can represent binary code (ones and zeros). Information can then be coded into the roadway in much the same way as computers use binary serial data streams. This data stream provides an index which, in combination with a lookup table, tells the vehicle where it is on the roadway (which mile marker, which exit, etc.), what are the upcoming road curvature changes, and other location-specific information.

The MSS then uses the roadway curvature information provided by the coding, as well as the vehicle's current information (speed, local trajectory relative to the magnetic markers, steering angle, location on roadway) to predict the vehicle's position at a future location if it were to continue on the same trajectory. The prediction information is displayed on the in-vehicle display, dramatically improving the operator's ability to keep the vehicle on the desired path. The MSS process is shown in Figure 4-2.

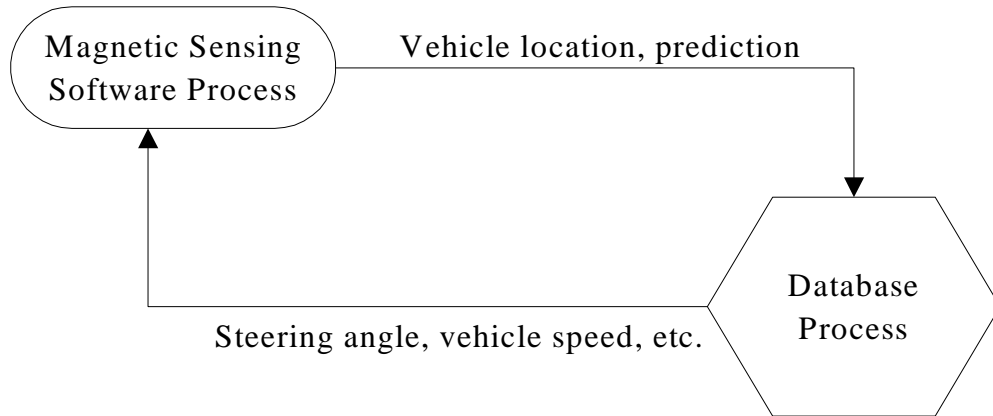

Figure 4-2: Magnetic Sensing Software Process Diagram

The vehicle's current position information is not very useful by itself for controlling the vehicle or providing driver assistance. One could simulate this approach by cutting a hole in the floorboard and attempting to drive by staring at the ground under the vehicle. This would obviously be a very difficult task, and would not be very successful. The purpose of the prediction information is to mimic a human's way of driving. Humans look at the road ahead and use their senses to estimate where their vehicle is heading. If they see a curve ahead and realize that their current trajectory would cause the vehicle to leave the lane, they compensate accordingly. The prediction information does exactly the same thing, showing (on the in-vehicle display) the future location of the vehicle based on the current trajectory, giving the operator the information needed to apply predictive input, thus allowing the operator to better maintain lane position. Use of prediction improves bandwidth, reduced effort, and often means the difference between stable and unstable behavior, as has been demonstrated extensively in the literature. For a recent discussion, see [23]. Further detail of the magnetic sensing system algorithm can be found in Chapter 6.

Database Process

As noted above, to allow prioritization of functions, the ASP-II software is split into several processes that run simultaneously. A database process was created to coordinate the processes and share information. The database can be written to and read from by all of the processes. Each process writes information that needs to be transferred into the database, then the process that needs the data reads it from the database. For any database variable, only one process is allowed to write the data, thus assuring synchronization and data integrity. Read-access is granted to all processes.

Data is stored in the database using named variables. Processes access information for the desired variable, or write information to it. The processes write and read data at about 10 Hz. Simultaneous read/write problems are handled automatically and more than one process can access the database at the same time. The database process, including data flow information, is shown in Figure 4-3.

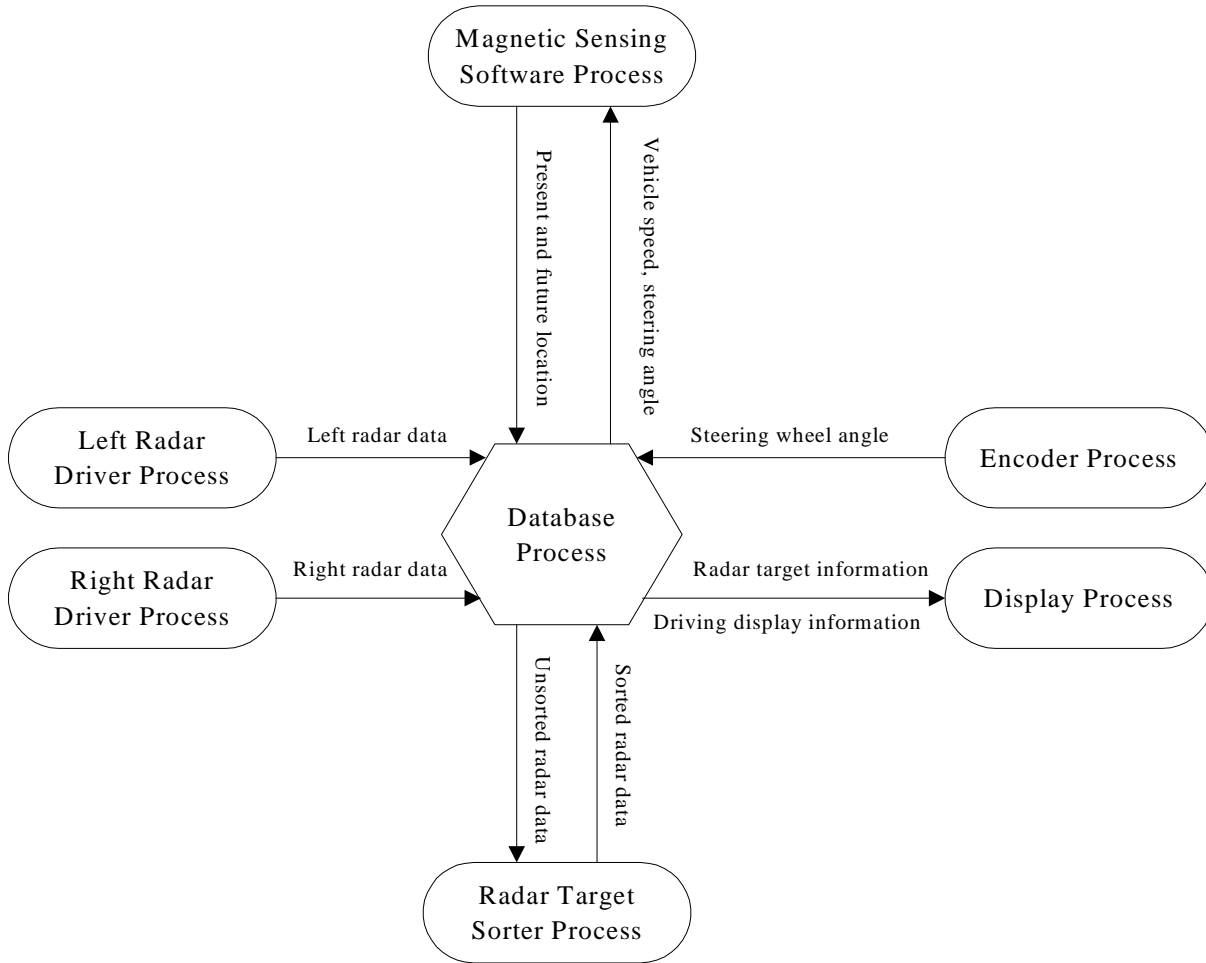

Figure 4-3: Database Process Diagram

Using the database dramatically improves the performance of the ASP-II software. The database is very robust and not prone to stalling, unlike other forms of interprocess communications, such as pipes.

Radar Driver Processes

There are two radar driver processes, one for the left side radar and one for the right side radar. Each driver reads range, azimuth, rate, quality, and target ID data from an Eaton Vorad radar unit (EVT-300) for each target detected and uses that data to generate collision warning information. Data is read at 10 Hz and is processed if any targets are detected. The EVT-300 model radar can detect and track up to seven targets simultaneously. Thus a maximum of fourteen targets, seven from each radar, can be detected.

The radar driver process reads in target information from the serial port and extracts the data fields. Then all target information is stored in the database for use by the Radar Target Sorter Process. The radar driver process is depicted in Figure 4-4.

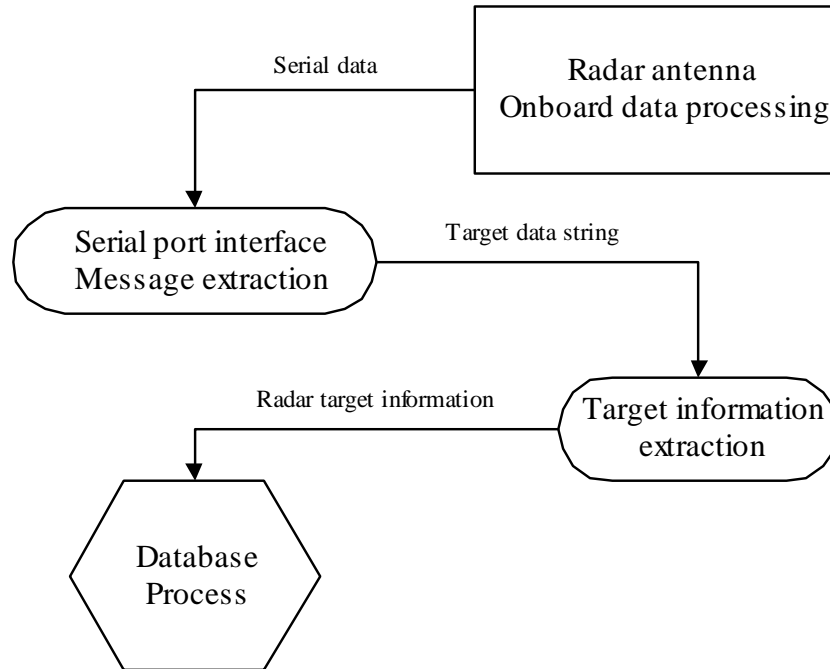

Figure 4-4: Radar Driver Process Diagram

Radar Target Sorter Process

The radar target sorter process sorts all target information from the radar driver processes and selects a maximum of three targets to send to the display process.

The radar target sorter process establishes virtual lanes in front of the ASP-II, assuming the ASP-II to be in the center of a lane, with a lane to the left and a lane to the right. Thus, any target detected in the center lane would be a collision candidate, while targets in the left or right lane would not. A target in the right lane would be a collision candidate if the wingplow were deployed. Clearly, the opposite is true for a plow equipped with a left-side wingplow.

Targets detected by the radar are first sorted by lane, then by longitudinal distance from the ASP. The closest target in each lane is selected and sent to the database for use by the display software. The distance to each target in feet, as preferred by the snowplow operators, is sent to the database in three variables: left target, center target, and right target. These variables represent the three corresponding lanes, as described above. Even if there are multiple targets detected in one lane, only one target will be sent for each lane. The radar target sorter process is depicted in Figure 4-5.

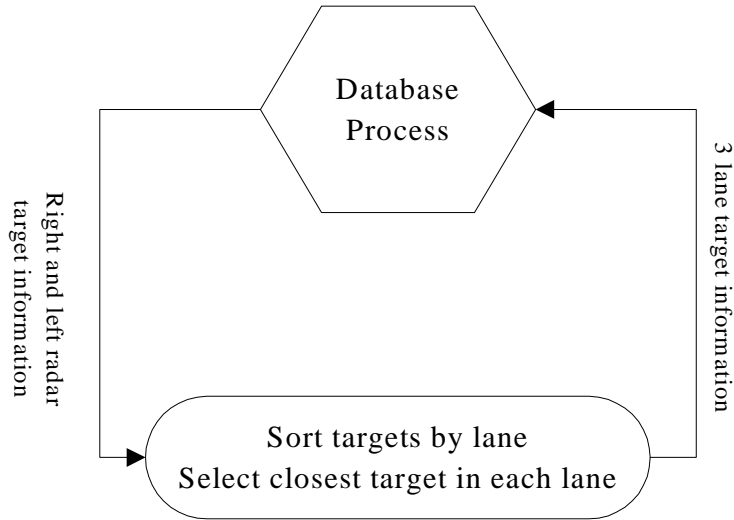

Figure 4-5: Radar Target Sorter Process Diagram

Encoder Process

The encoder process reads information from an absolute encoder connected to the ASP-II steering column. The encoder sends a turn value from 0 to 3600 for a single turn of the encoder, or 0.1 degree per encoder count. The gear ratio between the encoder and the steering column is 13:6, with resulting resolution of $(0.1) \times (2.1667) = 0.217$ steering wheel degrees per encoder count. The encoder process converts from the encoder count to the vehicle's steering wheel angle and outputs the vehicle's current steering wheel angle to the database.

The program also tracks multiple encoder turns. When the vehicle is first started and enters a lane instrumented with magnets, the MSS process reads a series of magnets and obtains the vehicle's trajectory, from which it estimates the steering angle. When the program finds the steering angle between ± 60 degrees, it zeroes the encoder turn count. Once the count has been initialized, the encoder program keeps track of the number of turns and in which direction they are made, thus enabling the program to give accurate steering wheel angles for multiple turns of the encoder. The database steering wheel angle is updated regularly, and is used by the MSS to predict the vehicle's future location, a key aspect of the lateral assistance portion of the HMI. The encoder process is shown in Figure 4-6.

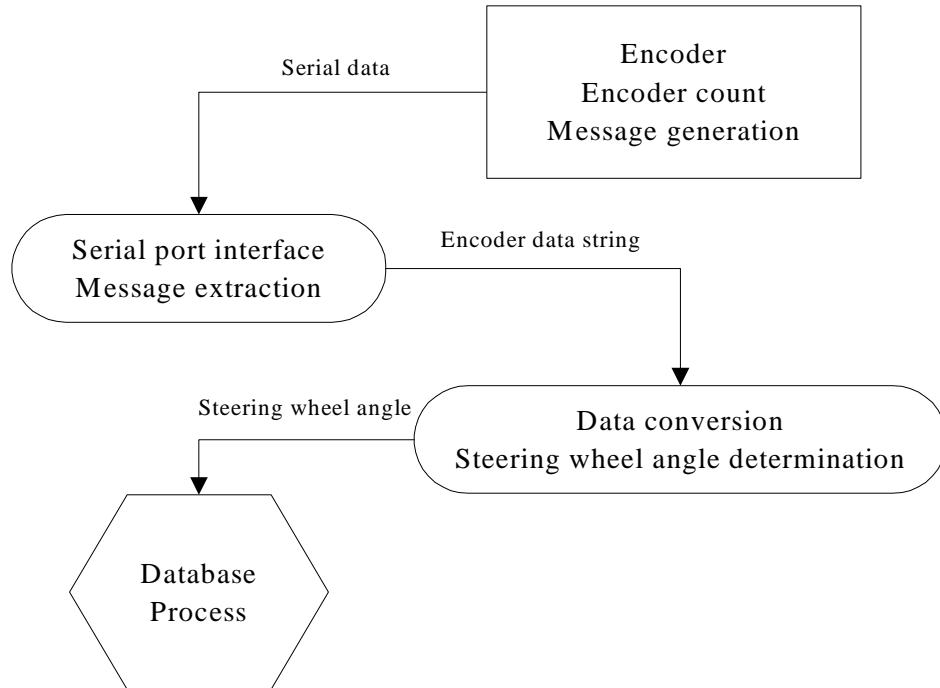

Figure 4-6: Encoder Process Diagram

Display Process

The display process creates a user-interface display based on the information generated by the radar and MSS processes. As shown in Figure 4-7, the display process presents radar information in the left panel of the screen, and provides MSS roadway information in the main portion of the screen.

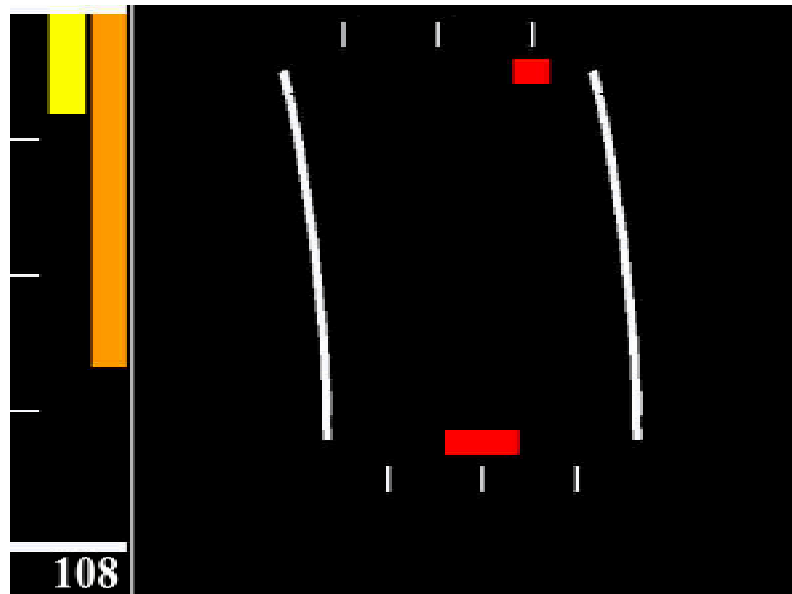

Figure 4-7: Screen Shot of the In-Vehicle Display.

Up to three radar targets can be displayed on the screen, each represented by a downward moving bar or “tape.” The radar process tracks multiple targets, and the display process was designed to display up to three targets, based on the needs of the plowing operation. The three columns on the radar portion of the display represent three distinct targets, left, center, and right of the plow. Targets are displayed starting from a distance of 100 m. As the targets approach the ASP-II, the bar representing the target grows longer, approaching the bottom of the screen. The distance to the closest target is displayed numerically in feet at the bottom of the screen. Progress of the bar toward the bottom of the display implicitly provides rate information to the operator.

The right panel of the display, comprising the majority of the screen real estate, provides lateral position and roadway geometry information. The tick marks at the top and bottom of the lane represent logical offsets, based on the need for up to a 0.6 m (2 ft) offset from lane centerline during normal plowing operations. The vertical curves represent the upcoming roadway curvature. The horizontal bar at the bottom of the display represents the current plow position, while the smaller horizontal bar at the top of the display provides a predictor of future vehicle position, based on current position, roadway geometry, and vehicle steering angle. Further details of the HMI display are provided in Chapter 5. The display process diagram is shown in Figure 4-8.

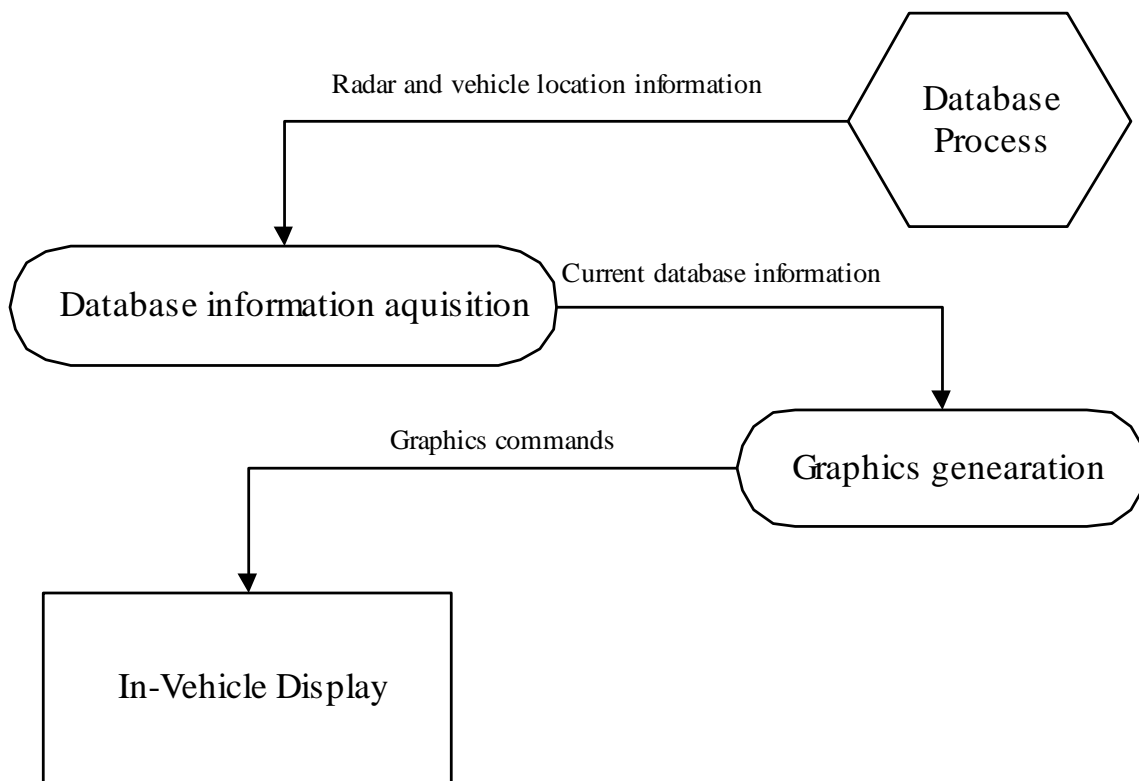

Figure 4-8: Display Process Diagram

CHAPTER FIVE

REFINEMENT OF THE ASP HMI

HMI Design Changes from ASP-I

The HMI display contained two major components, a forward collision warning system (CWS) and a lane-keeping system. The left-hand section of the HMI display contained CWS information derived from MMW radar data (Figure 5-1). Downward-moving tapes showed the distance to each of the forward targets. Distance rather than time was used as a metric due to operator requests and the fact that distance is a more valuable metric at slow speeds. Tapes were chosen as they mimic the forward approach of obstacles. The tape changed from yellow, to orange, and then red as the target approached. Yellow was chosen over green (which is recommended in [28]) due to the possibility of a red-green colorblind driver. The ASP-II iteration improved the CWS by placing targets in their matching lateral position (left, middle, right) with respect to the plow, improving detection accuracy, and reporting the distance to the closest target in feet. Driver comments indicated that while Caltrans promotes meters, drivers were more comfortable with time-critical information being presented in feet. Future iterations may include auditory warnings.

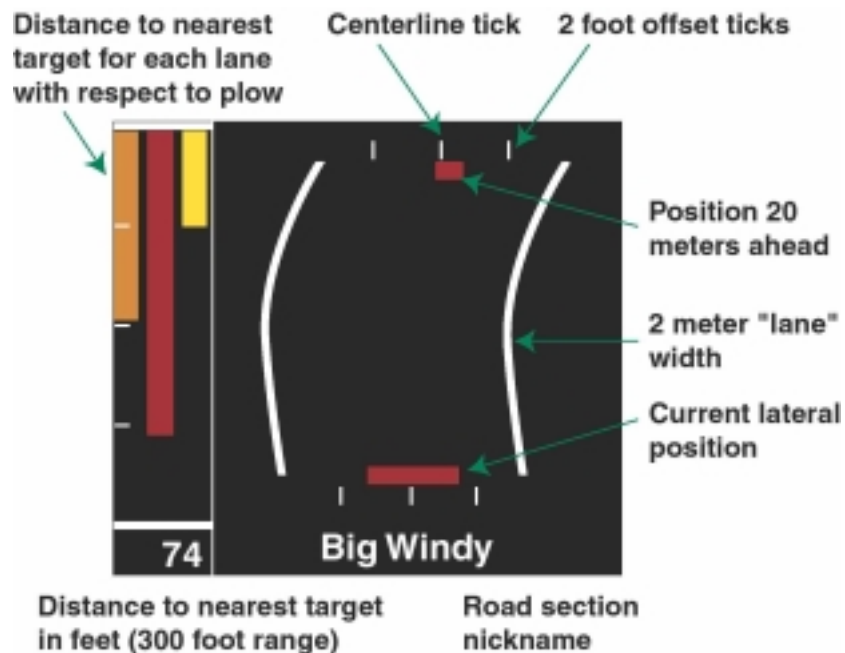

Figure 5-1: ASP-II HMI characteristics

To reduce the possibility that drivers would integrate the collision warning display with the shorter distance lateral display, a line was used to separate the sections (Figure 5-1). Conversations with the drivers indicate that this simple design characteristic achieved its purpose. A major component of the lateral assistance display was the prediction feature. This marker showed the future lateral position 20 m ahead corresponding to the magnitude and

direction of the steering wheel angle. When the steering wheel was turned left, the prediction marker moved left. The current lateral position of the truck was shown at the bottom of the display. The graphics represented a displayed longitudinal distance of 20 m with a 2 m width between the “curbs.” Road lines were computed using an internal map database of road curvature and heading angle, indexed based on code from the roadway magnets. Driver could steer by positioning the predictor at any desired “future” location.

As in ASP-I, the center tick marks indicated the center of the lane, while the exterior tick marks indicated 0.6 m (2 ft) offsets. Offsets are used during certain plowing formations and are often done intentionally by snowplow drivers elsewhere in the United States [15]. Under normal conditions the lateral assistance lines were white and the current and prediction markers were red. If the computer was uncertain of its current longitudinal position on the track, but was detecting position markers (magnets), the whole lateral display turned yellow and showed a straight road. This signaled to the driver that the display should not be completely trusted. If the plow left the magnets, the color changed to gray and froze with a yellow arrow pointing back towards the lane center. This arrow was placed over the lane boundary that was crossed. After a short time off the magnets, the lateral display blanked out. Besides color changes and the yellow arrow, no lane departure warning was issued.

Also new to the display was the addition of road segment names below the lateral imagery. These names corresponded to the names used by the drivers for specific curves and stretches of road. Drivers suggested this addition during the ASP-I testing. Names were associated through software with specific longitudinal locations within the magnetic marker internal map.

A new flat panel display was also introduced to the system. This panel included an easy to operate brightness knob, an on/off switch, contrast control buttons, and a darker black background (similar features are also suggested in [15]). The display was considerably smaller than the one used for ASP-I and was mounted where a rear-view mirror would normally be located (Figure 5-2). The ASP was not equipped with a rear-view mirror as there is usually a sanding bed blocking the view through the rear window. Originally, the display was mounted on top of the dashboard near the driver's right hand. However, one of the drivers suggested moving the display to the rear-view mirror position so that shorter drivers could have a less obstructed view of the right-hand wingplow mirror. Interviews with other drivers revealed that this was a popular design modification and did not lead to undesirable obstruction of the forward field of view. The HMI was mounted on a double ball-joint mount, allowing the drivers to easily adjust the orientation and position of the display.

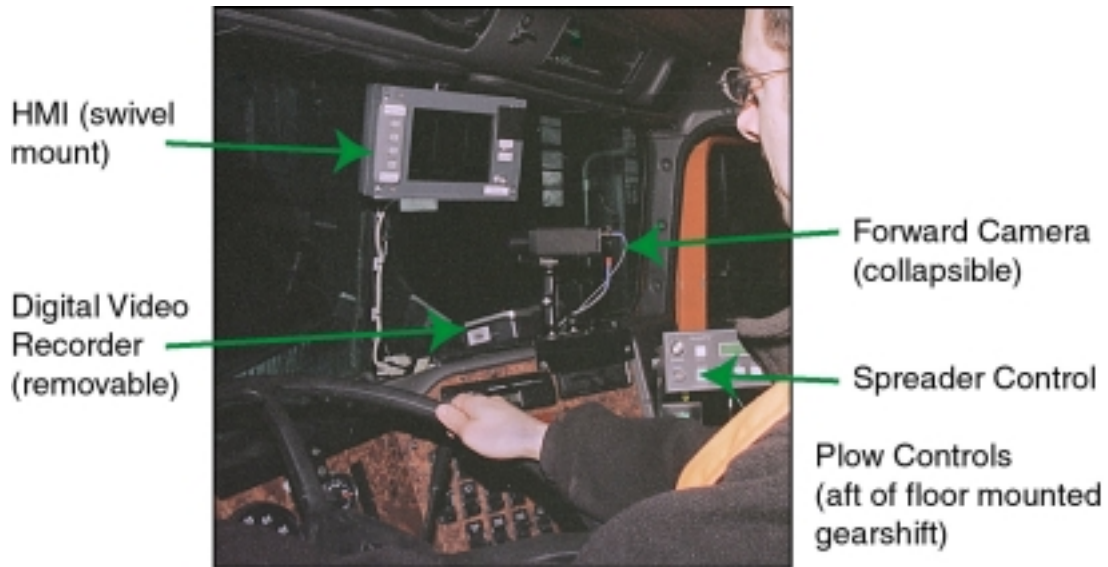

Figure 5-2: HMI and other Equipment Positioning

ASP-II also included a forward camera on a double ball mount. This mount allowed the camera to be easily lowered into a storage position. By default, the lens cap was left on the camera unless data collection was in progress. A driver-facing low-light camera in the upper-right quadrant of the HMI housing was typically covered with black tape. Unfortunately, this camera was not used during the 1999-2000 winter due to problems with the video quad-processor. Video output was recorded on a small, handheld digital video recorder that was removed from the plow when data was not being collected. This portable unit was usually kept either in the researcher's lap or on top of a bag placed on the floor.

Lateral assistance improvements were also made to the control dynamics, with the intent of making it easier to reach and maintain a stable lateral state [25]. Parameters were tuned towards easy learning, reduced oscillation, and limited visual demand. All tuning and redesign was done using a simulation of the snowplow consisting of a video game steering wheel attached to a computer and monitor. No formal experiments were run as the control dynamics were being modified daily. Prior to delivering the plow to Donner Summit, closed-track system calibration occurred at the Crow's Landing Test Facility. During this testing, the development team quickly confirmed the parameter tuning with the help of a Caltrans driver who had no prior system experience.

For more detailed descriptions of the ASP HMI design process from a human factors and control point-of-view, see [18, 19, 25].

Arizona Findings

As Arizona typically experiences large snow accumulations during February, the ASP was tested at Kendrick Park during February 2000. However, during this period, Arizona had little significant snowfall during the initialization and training phase, and the project team collected no on-road data. However, the plow was used for two weeks in normal winter operations, with several moderate snow events during that time. Flagstaff District operators logged about

1280 km (800 miles) of plowing activity in this second phase, both on the test site and the adjacent sections of highway. The system operated well during this testing, with the exception of water infiltration at the OEM radar antenna connection for the EVT-300—this issue was addressed through additional sealing material.

As with the previous year, a survey generated by the human factors team member was given to the ADOT drivers who had the opportunity to drive the ASP. The survey (see Appendix B) was very similar to the one used during ASP-I. As seen in Table 5-1, drivers generally displayed highly positive responses to the system. Like ASP-I, the CWS received lower ratings than the lane-keeping component, yet the scores were still better than neutral. The four drivers who were exposed to the ASP-I overwhelmingly indicated that the system had improved during the redesign.

Table 5-1: Survey Results for ASP-II

	Mean	N	Min	Max
Open Ended				
Experience (years)	6.43	15	1	20
Time on ASP (hours)	1.80	10	1	3
1-5, Higher Being Better				
Overall: Easy to use	4.33	15	3	5
Overall: Like	4.40	15	3	5
Overall: Like with More Practice	4.53	15	3	5
Potential to Improve Safety	4.47	15	2	5
Potential to Improve Efficiency	4.47	15	3	5
CWS: Easy to Use	3.73	15	1	5
CWS: Like	3.93	15	1	5
Lane-keeping: Easy to Use	4.47	15	3	5
Lane-keeping: Like	4.53	15	2	5
Better this Year	4.50	4	4	5

The driver who consistently marked the lowest scores for the system and components was a relatively inexperienced snowplow driver. Comments from this driver included dissatisfaction with the limited range of the CWS and inability of the CWS to work in curves, suggestions for 3-D graphics for lane-keeping, as well as indications of milepost number (instead of landmark) and gradient change. The latter two suggestions and a bridge indicator were discussed within the design team prior to the 1999-2000 winter, however time constraints resulted in these features not being included. Several other drivers also suggested a milepost indicator; this feature will be added in follow-on research. In general, comments were positive for the lane-keeping component, but negative for the CWS. Dissatisfaction with the CWS was mostly in the form of erroneous (noise) and extraneous (signs) signals. The researchers are currently investigating solutions for these issues, and have implemented algorithms for improved performance through curves. These improvements were not implemented on the ASP in time for operator testing, and will be evaluated in future research.

Similar to the surveys given during ASP-I, drivers were asked "How long do you think you would need to become comfortable with this system?" The subject pool sizes for each year are similar (17 and 15 respectively). Figure 5-3 demonstrates a favorable shift towards shorter time estimates. Specifically, the fraction of drivers indicating that achieving comfort would take less than three days shifted from about half to about three quarters.

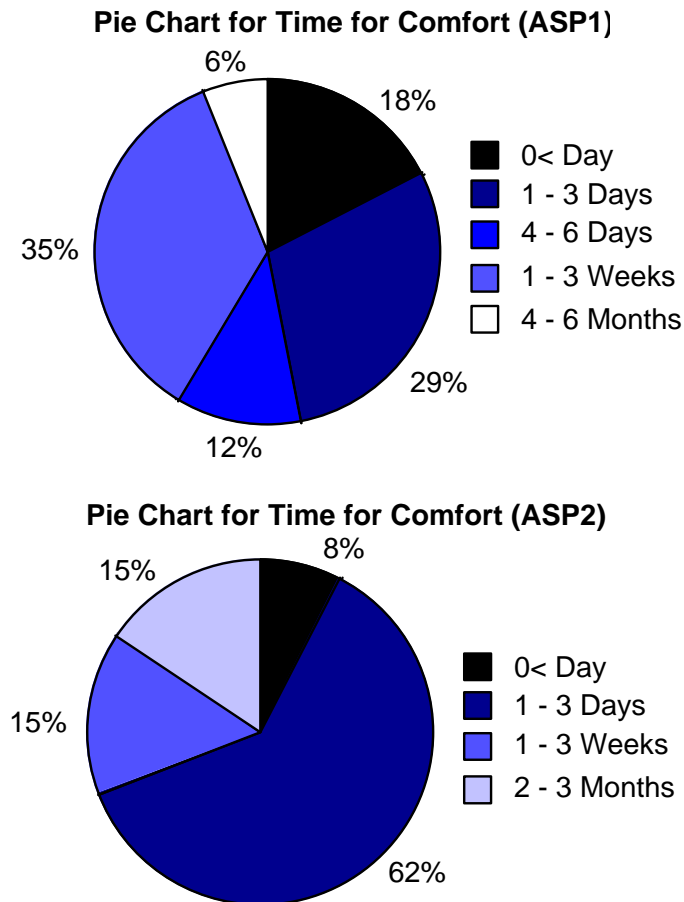

Figure 5-3: Comparison of Estimated Time for Comfort between ASP-I and ASP-II

There are, however, two potential biasing factors. First, there are four repeat subjects from the first year. It is not known how their answers shifted as their surveys could not be linked across the two years. Analysis during ASP-I implied that more time on the ASP led to shorter answers. Second, many drivers this year used "storms" instead of days as units. These were converted as one storm being one day. However, it is possible that some of the drivers interpret a storm to last more than one day.

California Findings

General Comments Regarding Data Collected While Plowing

During the winter of 1999-2000, the ASP rotated between three plowing formation positions. Note that this only affected runs where actual plowing occurred. Whenever possible, usually when the wingplow was broken, it was used as the lead plow pushing to the left. This allowed consistent runs over the instrumented lane.

Another common position was as the lead plow pushing right, typically when the wingplow was working. Under this scenario two or three plows were ahead of the ASP pushing to the left shoulder while the ASP and another plow would clear the remainder to the right shoulder. This scenario led to runs that required more data to be removed as the ASP would sometimes be required to deviate from the instrumented lane to accommodate improper positioning of the lead plow.

The third plowing scenario was when the ASP was used to clean up the shoulders. These runs were required when the formation of the previous run was inefficient or did not have enough operational plows to provide full coverage. As the ASP was not over the instrumented lane, this resulted in no data collected. These runs were more common when storms were either dying off or in a lull, so that drivers typically did not encounter low visibility conditions.

Most of the data shown here was collected in person by the human factors team member. As the ASP-II did not have an automated data collection capability, the data was collected during a series of ride-alongs. While providing a great deal of time for interviews and observations, this drastically reduced the potential objective data set even though the human factors team member was "on call" for storms. Given the cost and time needed to reach the summit (about 3 hours each way) and the high variability of weather forecasts, storms were often missed. Attempts to be present as a precaution when a storm's strength was unknown often resulted in being present when no serious storm occurred. Furthermore, ride-alongs were often limited to 12 hours as only one team member was present. As such, the data shown here only reflects a small sample of storm events over Donner Summit. Due to the limited number of available data collection runs under the ASP-II study, definitive judgment on the full merits of the system must be deferred for a future study.

Learning

As in ASP-I, Caltrans drivers were introduced to the system in an informal manner. New to the system was a switch that placed the ASP into a simulation mode. As a safety precaution the simulation was gated by wheel speed and could only be used when the plow was not in motion.

The system was “tricked” into thinking it was traversing the Donner Summit route at a constant speed. Caltrans operators could then “drive” the run using the system. The simulation was provided as a training tool, but was used infrequently as PATH staff typically trained drivers during operational runs as a storm was approaching or, in some cases, underway. The simulation mode proved valuable for static demonstrations.

One design goal repeated from ASP-I was the requirement that the system be easy to learn. PATH researchers encountered the opportunity to directly examine whether this design goal had been achieved on one of the days in which they were present. A Caltrans driver who used the system during the ASP-I testing and was experienced with snow removal in general, received additional exposure to the system during Donner Summit calibration for the ASP-II iteration. His initial comments were that the changes in the system dynamics were much more stable and easier to use. The next day, a new driver was introduced to the system. Sub-optimal instruction occurred near the end of a 12-hour storm shift, followed by three runs with the system during sanding operations. Following these three runs, a shift change occurred and the experienced driver continued the sanding duties. His first four runs under identical climate and task conditions are shown in conjunction with the new driver's performance in Figure 5-4. Note that for mean speed, lateral displacement (LD) magnitude, and vehicle-to-road angle (VA) magnitude, the new driver quickly reached performance levels comparable to the experienced driver. These findings suggest that the improvements in the system dynamics did indeed improve ease of learning. Additional training sessions with other drivers and informal observations reinforced the results seen here.

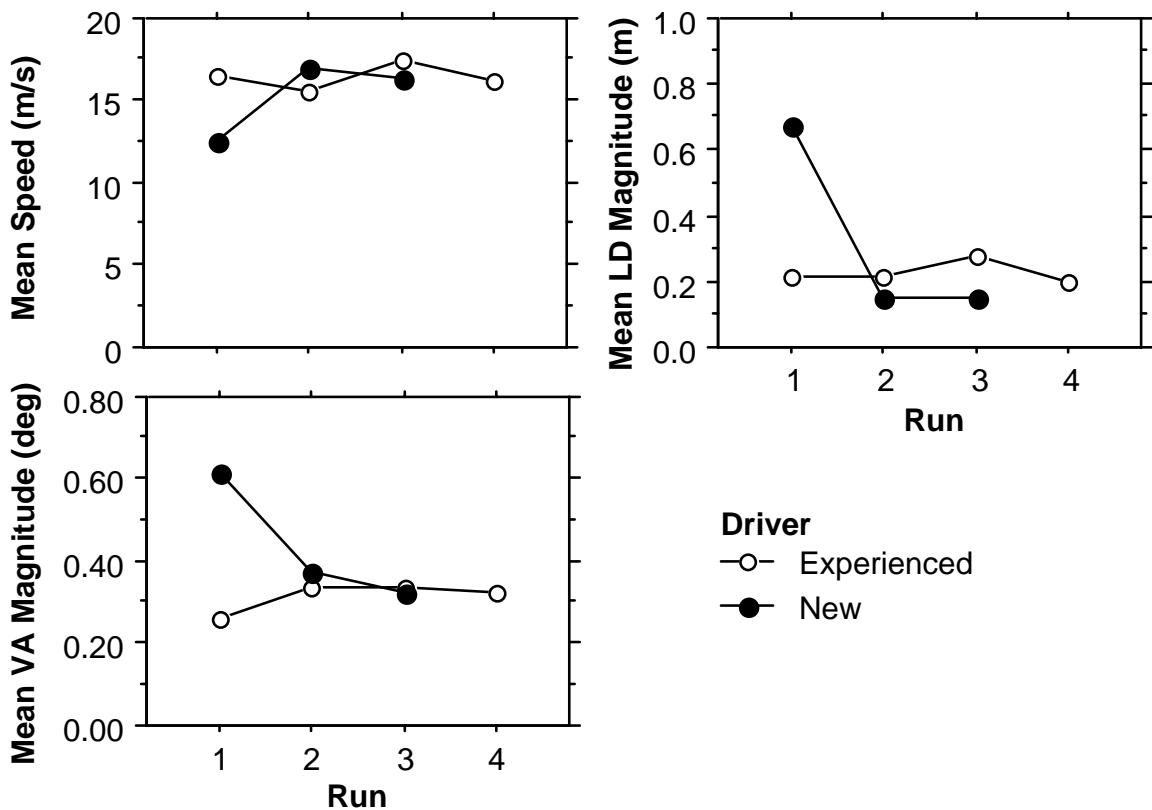

Figure 5-4: Learning Performance under Sanding Conditions

General Data Findings

Twenty-nine data runs scattered across five drivers and six days were collected at Donner Summit, CA. Extraneous events (e.g., moving out of the test lane to pass a tractor-trailer, etc) were not included in the data. The display was turned off for six of these 29 runs in order to provide an estimate of baseline performance. Table 5-2 shows the breakdown of the conditions. Due to the unpredictability of conditions (even within a single storm) it was not possible to create a balanced data collection scheme. The 29 runs examined here include the seven runs used for the learning subsection analysis.

Table 5-2: Testing Conditions

Removal Actions	Day		Dusk		Night		Off	On	Total
	Off	On	Off	On	Off	On	Subtotal	Subtotal	
None	2	2	0	1	0	0	2	3	5
Sanding	1	8	0	4	0	0	1	12	13
Plowing	1	1	0	0	2	7	3	8	11
Total	15		5		9		6	23	29

One interesting trend was that of the six days PATH researchers collected data, all plowing activities were during the night. Dusk and daylight conditions were usually sanding operations. PATH researchers attempted to be present when weather forecasts predicted heavy snowfall over more than one day. Thus, “none” and “sanding” conditions typically occurred during system integration checks or when snowfalls were not as severe as predicted. The ASP was in Arizona during February, a typically heavy snowfall month for Donner Summit. Given that there were only eleven recorded plowing runs, "None" and "Sanding" conditions were included in analyses in the hope that they may shed light on the value of the system.

Regression analysis of lateral displacement magnitude for Removal Actions (None, Sanding, Plowing) and Display (Off, On) found significant differences for both main effects and the interaction (all at $p < 0.0001$). Functional differences occurred mostly under the plowing conditions where use of the display led to significantly better lateral performance (Figure 5-5).

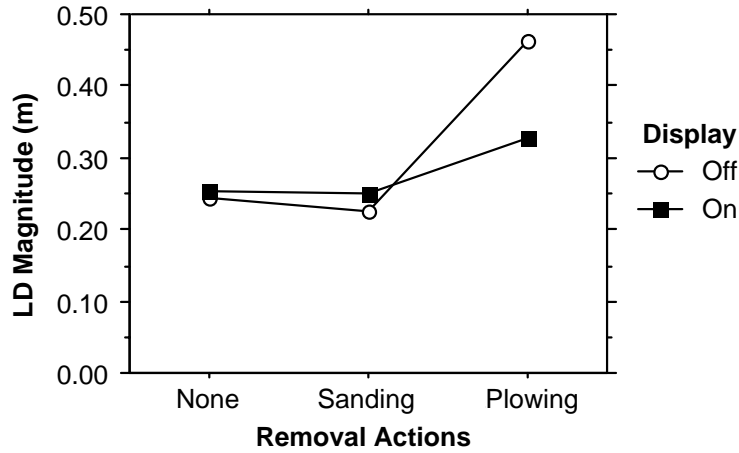

Figure 5-5: Lateral Displacement Performance

Again, regression analysis of speed for Removal Actions (None, Sanding, Plowing) and Display (Off, On) found significant differences for both main effects and the interaction (all at $p < 0.0001$). However, functional differences were slight as speed differences were under 10 km/hr (6.2 mph) (Figure 5-6). This implies that while statistically different, there may not be much difference in speed due to the small separation between the means.

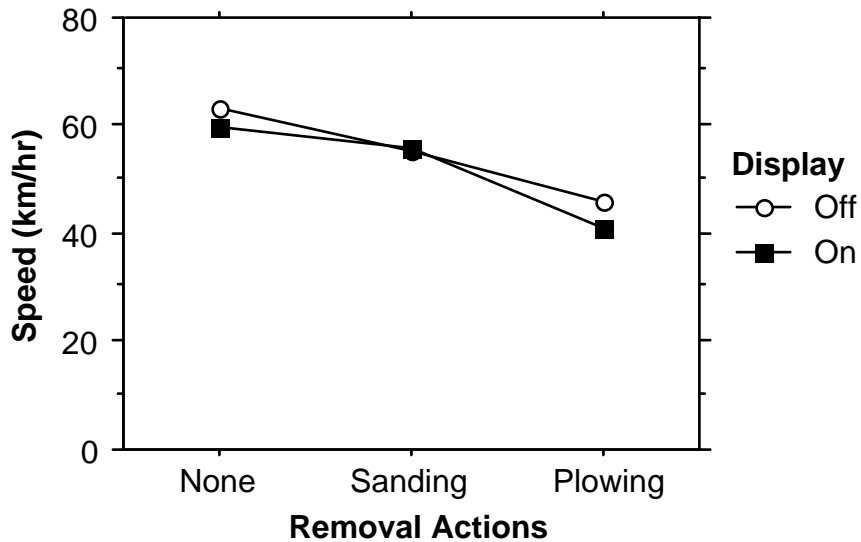

Figure 5-6: Speed Performance

A measure typically used for determining the mental workload of a driver is the steering wheel standard deviation. The premise is that larger values correspond to higher workloads. Figure 5-7 shows that a small increase in steering wheel standard deviation was seen when the display was on under the plowing conditions. However, this increase is not very large and is similar to levels seen under sanding operations. It is probably safe to assume that the workload increase from using the HMI has minimal impact on snow removal operations.

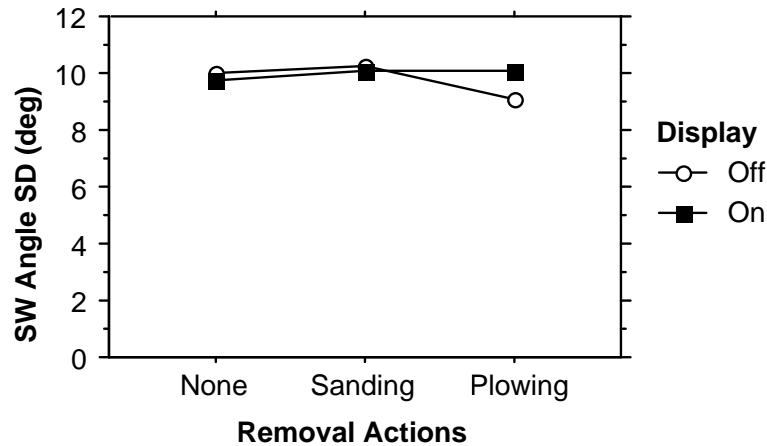

Figure 5-7: Steering Wheel Standard Deviation Performance

Another interesting relationship was seen between speed and lateral displacement magnitude. When correlations were run under the display off and on subsets, correlations dropped from -0.356 to -0.214 respectively (both $p < 0.0001$). This implies that when the display was on, the driver's lateral displacement magnitude was less likely to be related to speed. However, this may be an artifact of the difference in conditions (lighting, removal actions) rather than a function of HMI presence.

Figure 5-8 shows a further examination of lateral displacement while plowing as a function of road position. In this figure, lateral displacement was split for each road segment (using driver nicknames). "Blank" refers to the few locations along the track where no road segment is assigned. All other segments are in order from left to right. Note that when the system is in use the driver maintains a much more uniform position around the center of the lane.

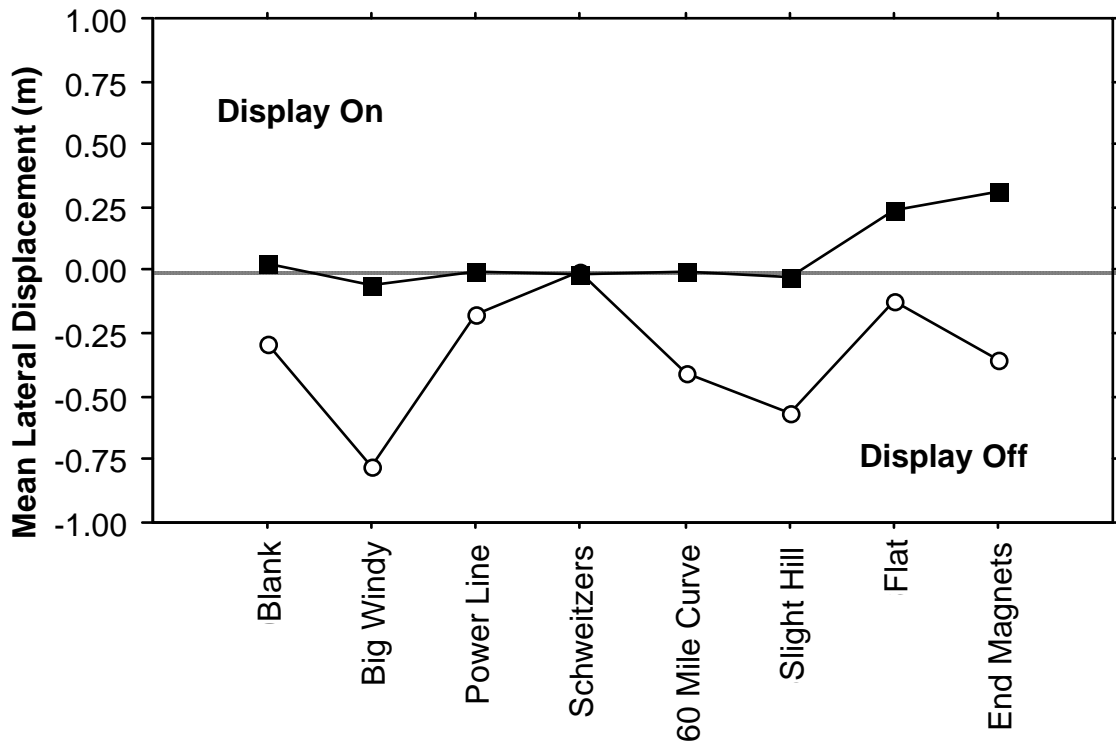

Figure 5-8: Lateral Displacement when Plowing by Road Segment

It is reasonable, and somewhat expected, for the driver to drift to the left for the last two segments as the right hand lane (#3) drops during the "Flat" segment. It is not unusual that the worst performance was seen on "Big Windy" as it is a substantial right curve where wind patterns often reduce vision. Interestingly, this particular segment was identified very early on in the project by drivers as an area where the system was expected to be especially useful.

Overall HMI Conclusions

It is clear that the ASP-II HMI has the potential to be quite beneficial to driver safety and confidence. The findings from the lateral-assistance portion of the display suggested that, even with limited instruction, the interface was intuitive and easy to learn. Most drivers were observed to reach a stable level of performance after driving the ASP-II for one Donner Summit run or less (about four miles). Anecdotal comments and experimenter observations also suggested that the display could easily be used either for reference or as a primary driving mechanism.

Based upon analyses of objective data, the system appears to allow drivers to more consistently maintain a stable position near the lane center. Small drops in performance for speed and steering wheel standard deviation while the system was on do not appear to have substantial functional relevance even though there were statistically significant differences. As such, driving with the system appears to be quantifiably similar, if not slightly better, than unaided driving. In addition, note that the comparisons between "display on" and "display off" were made under less

than whiteout conditions. Under whiteout conditions, the display will allow plowing operation to continue in situations where it would not be safe to plow without such a device.

Furthermore, this work suggests that a simple, low-fidelity display reminiscent of early video games can lead to an effective and well-received system. The initial decision to go with a "low-tech" image during ASP-I was based on computational concerns and a desire for simplicity. However, drivers responded well to the display and field measurements showed good performance can be achieved without computationally intensive graphics or custom hardware, a feature that has direct ramifications on commercialization and deployment.

CHAPTER SIX

MAGNETIC SENSING SYSTEM

Introduction

The development of a reliable and accurate lateral referencing system is crucial to the success of the lateral guidance system of the snowplow. PATH has proposed and developed a lateral referencing and sensing system that is based on the magnetic markers embedded in the road center to provide the lateral position and road geometric information [32]. The snowplow steering guidance system based on such technology provides the driver with the following two fundamental pieces of information that support steering control: the vehicle position with respect to the roadway, and the current and future road geometry. Furthermore, the high accuracy of such a lateral referencing system offers sufficient resolution enabling the calculation of other vital information for the stability of human steering control [21]. Under ASP-I, two arrays of magnetometers, one located behind the front wheels and the other at the rear of the truck, were used to simultaneously obtain front and rear lateral offset measurements. Those measurements were then used to derive vehicle information such as heading angle for the predictor calculation. During ASP-II, it was found that the front magnetometer array is sufficient for such calculation as long as the noise of the position measurement is small enough to support a mathematical observer to estimate the vehicle-heading angle. By eliminating the rear magnetometer array, significant cost reduction as well as reliability improvement of the snowplow guidance system can be achieved. In this chapter, the background of the magnetometer signal processing will be reviewed first, followed by discussions of the lessons learned from the snowplow signal processing experience.

Extensive development and experimentation has been performed on magnetic marker-based lateral sensing systems for many PATH vehicles equipped with automated steering control [24]. The vast knowledge available about this lateral sensing technique was one of the primary reasons that this technology was first chosen to support the steering guidance system. Other positive characteristics of this lateral sensing technique include good accuracy (better than one centimeter), high reliability, insensitivity to weather conditions, and support for binary coding. The requirement of modifying the infrastructure (installing magnets) and the inherent “look-down” nature (the sensor measures lateral displacement at locations within vehicle physical boundaries, versus look-ahead ability) of the sensing system [10] are two known limitations of this technology. Although the associated application software for this sensing system can be quite involved, the principle is straightforward. Magnetic markers are installed under the roadway delineating the center of each lane; other configurations can be supported as appropriate for different applications. Magnetometers mounted under the vehicle sense the strength of the magnetic field as the vehicle passes over each magnet. Onboard signal processing software calculates the relative displacement from the vehicle to the magnet based on the magnetic strength and the knowledge of the magnetic characteristics of the marker. This computation is insensitive to the vehicle bouncing (e.g., heave and pitch) and the ever-present natural and man-made magnetic noises. Furthermore, road geometric information can be encoded as a sequence of bits, with each bit corresponding to a magnet [9]. The polarity of each magnet represents either 1 (one) or 0 (zero) in the code. In addition to the lateral displacement measurement and

road geometry preview information, other vehicle measurements such as yaw rate, lateral acceleration, and steering wheel angle may also be used to improve the performance of such a lateral guidance system [5, 21].

The following sections review the background information on both the magnetic marker concept and the development of a reliable magnetometer sensor signal-processing algorithm. The last section discusses some lessons from the ASP-II experience.

Magnetic Marker Model

A representative mathematical model of the magnetic marker provides a base for understanding of many important issues regarding the design of a reliable signal-processing algorithm. Among these issues, how to reliably detect the magnets, how to remove the effect of vehicle bounce, and how to desensitize the noise disturbance effects, are the key problems that determine the effectiveness of any algorithm. PATH researchers have chosen to model the markers as magnetic dipoles for analysis. Aside from its relative simplicity and compactness, extensive testing at the Richmond Field Station reveals a strong correlation between model prediction and empirical measurements [32].

Under the dipole assumption, the magnetic field, $\vec{B}(x, y, z)$, at some location, $\vec{P}(x, y, z)$, can be given by

$$\vec{B} = \frac{\mu_0 M}{4\pi r^5} (3xz\vec{i} + 3yz\vec{j} + (2z^2 - x^2 - y^2)\vec{k}) \quad (6-1)$$

where $r = \sqrt{x^2 + y^2 + z^2}$, μ_0 is the permeability of free space, and M is the magnetic moment of the magnetic marker. Also note that the coordinate system ($\vec{P} = x\vec{i} + y\vec{j} + z\vec{k}$) is chosen so that $x\vec{i}$ corresponds to the direction of vehicle travel, $y\vec{j}$ the lateral deviation, and $z\vec{k}$ the height, relative to the marker's center.

From Equation (6-1), it is clear that, at any given longitudinal location x , in particular at $x=0$, i.e. immediately over the magnet, there exists a one-to-one and into mapping from the magnetic field $\vec{B}(0, y, z)$ to the sensor location $(0, y, z)$. Therefore it is theoretically plausible to invert this mapping to obtain the lateral deviation as well as the sensor height at the sensor location just as the vehicle passes over each magnet ($x=0$). The method of inverting this mapping can be analytical, numerical, or experimental. One crucial determining factor for designing a real-time algorithm of the inverse mapping is the tradeoff between the algorithm's effectiveness in handling noise and the algorithm's complexity.

Noise Effects

Four major noise sources are usually present in the magnetic signal measurements in a typical vehicle operational environment: earth field, local magnetic field distortion, vehicle internal electromagnetic field, and electrical noise.

The most frequent external disturbance is the ever-present earth's permanent magnetic field, which is usually on the order of 0.5 Gauss. The value of the earth field measured by the magnetometers on the vehicle depends on the location of the vehicle on earth as well as the attitude and orientation of the vehicle. Although the earth magnetic field usually change slowly, sharp turns and severe braking can quickly change the value of measurements along the vehicle axes.

The most serious noise problems are caused by local anomalies due to the presence of roadway structural supports, reinforcing rebar, and the ferrous components in the vehicle. Underground power lines are another source of such local field distortion. Rebar or structural support usually creates a sharp change in the background magnetic field and sometimes is difficult to identify. Most signal processing algorithms will have some difficulty recovering from such sharp distortions. The ferrous components in the vehicle, on the other hand, can be isolated as long as their locations are fixed with respect to the magnetometers, or are located a significant distance from the sensors.

A third source of noise comes from the alternating electric fields generated by various motors operating in the vehicle. These motors may include alternator, fan, electric pump, compressor and other actuators. However, their effects vary according to the motor rotational speed and distance from the magnetometers. The higher the motor rpm or the farther it is placed away from the magnetometers, the less the resultant noise. Sometimes modest changes in sensor placement can alter the size of such disturbances.

The last common noise source arises from the electronic noise in the measurement signal itself. Such noise can be created by the voltage fluctuations in the electrical grounding or from the power source. It can also be a result of poor wiring insulation against electromagnetic disturbances. Usually, the longer the wire, the higher such noise. Although low-pass filtering can reduce the magnitude of such disturbances, noticeable degradation of the magnetic sensor signal process algorithm occurs when such noise level exceeds 0.04 Gauss. Researchers at AHMCT are developing an improved sensing system that includes digital transmission of all critical data, which will essentially eliminate this noise component. This system is in initial testing at this time, and work in this area will continue in future research.

Magnetic Sensing Algorithm

One of the important attributes of the lateral sensing system is its reliability. Currently, several algorithms exist designed to detect the relative position between the marker and sensor (magnetometer), as well as to read the code embedded within a sequence of these markers. Three magnetic marker detection and mapping algorithms have been experimented with by PATH [32]. The first is called the "peak-mapping" method that utilizes a single magnetometer to estimate the marker's relative lateral position when the sensor is passing over the magnet. The second algorithm is the "vector ratio" method and it requires a pair of magnetometers to sample the field at two locations. It returns a sequence of lateral estimates in a neighborhood surrounding, but not including the peak. The third is the "differential peak-mapping" algorithm that compares the magnetic field measurements at two observation points to eliminate the common-mode contributions and reconstructs a functional relationship between the differential sensor readings and the lateral position using the knowledge of the sensor geometry. The "peak-mapping"

algorithm was selected for the snowplow project because it has been proven effective over a wide range of speeds and has been widely applied in many experiments conducted by PATH.

Under the assumption that vehicle lateral speed is significantly smaller than longitudinal speed, it is obvious that the largest vertical field B_z occurs at the point when the sensor is just passing over the magnetic marker, i.e. as $x=0$. This point is called “peak” because it corresponds to the point where the magnetic field achieves its maximum during its trajectory around the magnetic marker in question. The most important fact is that the three-dimensional mapping of equation (6-1) can be reduced to a two-dimensional mapping using the constraint relationship $x=0$.

Two basic methods can be used to detect the peaks: the variance method (using B_z) and the switching method (using B_x). The variance method computes the instantaneous variance of the vertical field $\sigma_z(t_k)$ as

$$\sigma_z(t_k) = \sum_{i=k-N}^k (B_z(t_i) - \bar{B}_z(t_k))^2 \quad (6-2)$$

where $\bar{B}_z(t_k)$ is the running average of the last N samples, i.e.,

$$\bar{B}_z(t_k) = \frac{1}{N} \sum_{i=k-N}^k B_z(t_i). \quad (6-3)$$

Using this variance, the peak and the valley of the vertical field can be identified using the following relationship

$$\text{if } |B_z(t_k) - \hat{B}_{zEarth}| > HIGH_threshold \ \& \ \sigma_z(t_k) < \varepsilon \Rightarrow \text{Peak detected}, \quad (6-4)$$

$$\text{if } |B_z(t_k) - \hat{B}_{zEarth}| < LOW_threshold \ \& \ \sigma_z(t_k) < \varepsilon \Rightarrow \text{Valley detected}. \quad (6-5)$$

Here, ε is a small value to be empirically selected. Equation (6-5) suggests that the marker is far enough away from the sensor that the field from the magnetic marker is negligible. Thus the vertical and horizontal earth field estimates (B_{zEarth}, B_{yEarth}) can be updated based on the sensor measurements at the valley. It should be noted that the earth estimates play a very important role in the accurate computation of the lateral deviation.

To improve the reliability of the peak detection process, the switching method utilizes the sign-change property of the longitudinal field (B_x) at peak both to provide candidates for peaks and to double-check any detected peak.

Once the peak is detected and the marker’s magnetic field is computed as

$$B_{zMagnet} = B_z(t_m) - \hat{B}_{zEarth}, \text{ and } B_{yMagnet} = B_y(t_m) - \hat{B}_{yEarth}. \quad (6-6)$$

By setting $x=0$ on Equation (6-1), the slope function between the vertical and horizontal field of \vec{B}_{Magnet} can be expressed as

$$\frac{B_{zMagnet}}{B_{yMagnet}} = \frac{2z^2 - y^2}{3yz} \equiv \varphi(y, z). \quad (6-7)$$

It is known from calculus that the curve (B_z, B_y) form a field if $\varphi(y, z)$ is single-valued, or that partial derivatives of $\varphi(y, z)$ do not vanish. Since

$$\frac{\partial^2 \varphi(y, z)}{\partial y \partial z} = \frac{y^2 - 2z^2}{3y^2 z^2} \neq 0, \text{ as long as } y \neq \sqrt{2}z, \quad (6-8)$$

under the restriction that $y \in \{y_{\min}, y_{\max}\}$ and $z \in \{z_{\min}, z_{\max}\}$, with $z_{\min} > 0$ and $y_{\max} < \sqrt{2}z_{\min}$, the curve $\{B_{yMagnet}, B_{zMagnet}\}$ does form a field. Therefore, the inverse mapping from $\{B_{yMagnet}, B_{zMagnet}\}$ to $\{y, z\}$ does exist for most of our application where z_{\min} is usually greater than 15 cm (5.9 in) and y_{\max} is less than 20 cm (7.9 in).

In the current snowplow environment, the magnetic field maps deviate quite significantly from the theoretical prediction from Equation (6-1) due to the massive amount of ferrous material from the plow blade structural support located in the vicinity of the magnetometers. Numerical mapping created by empirical data gathering (calibration) is used to create the associated inverse maps. Figures 6-1 and 6-2 show the magnetic tables for the snowplow in ASP-II for the seven magnetometers starting from the right side of the snowplow to the left, designated as follows: right-right, right, center-right, center, center-left, left and left-left. Each table is obtained with two sets of calibration data, one at 8-inch height and the other at 11-inch from the center magnetometer to the magnet. Each half-circle in the table consists of vertical and horizontal fields of the marker that are collected at the interval of every 2-cm lateral displacement. Since the snowplow front sensor array was installed with a 1-inch height offset between the right-right and left-left magnetometers, it can be observed from Figure 6-1 and 6-2 that the field strength reduces from right to left. Furthermore, the plots also show the very nonsymmetrical field characteristics due to the plow blade support structure. One advantage of this method is its robustness against height variations. Observe from Figures 6-1 and 6-2 that changes in z only serves to move the coordinates along the radial lines that denote constant y [32].

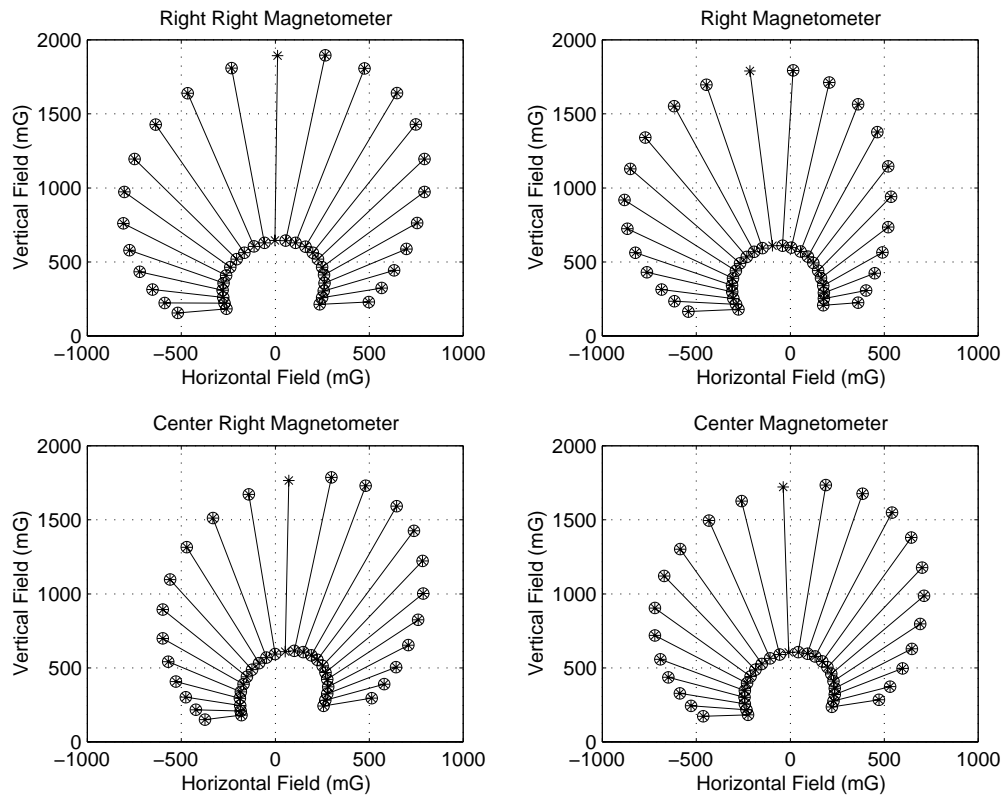

Figure 6-1: Snowplow Front Right Side (including Center) Magnetic Tables

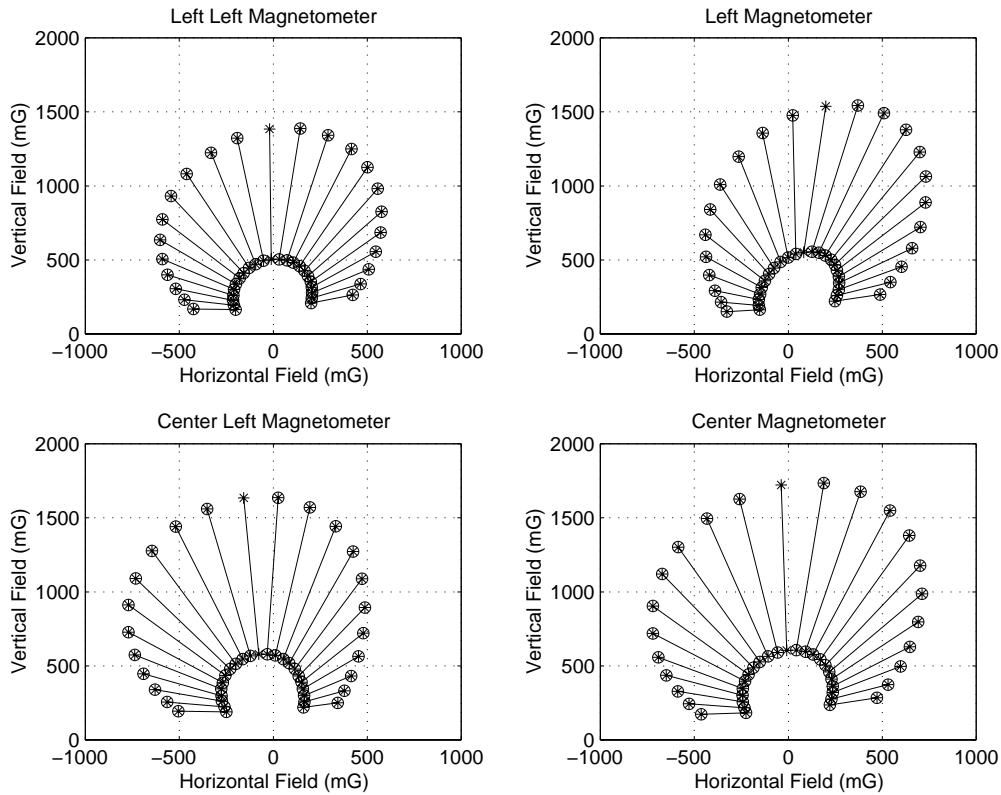

Figure 6-2: Snowplow Front Left Side (including Center) Magnetic Tables

Signal Processing Algorithm

The magnetometers signal processing for the “peak-mapping” method involves three procedures: peak detection, earth field removal and lateral displacement table look-up (see Figure 6-3 for block diagram of signal processing algorithm). Although it is straightforward in principle, it becomes complicated when the reliability of the process is the major concern. There are many parameters in the lateral sensing signal processing software that need to be tuned in order to provide consistent lateral displacement information regardless of vehicle speeds, orientations, operating lateral offsets and vehicle body motions. Debugging can become very time consuming when failure conditions cannot be recreated. To improve the reliability of the lateral sensing system with the magnetic road markers, PATH has developed a “reconstructive” software system for the lateral sensing signal processing. When specified as a “reconstructive run”, the real-time software in the vehicle, besides processing data as usual, stores all sensor data in memory and later dumps the data into a file. Signal processing software identical to the one run in the real-time environment can later on be generated in a desktop computer using the data stored during vehicle testing as inputs with the same QNX operating system. In such a setup, any erroneous situation can be recreated in a lab environment and debugged with ease. With this new development environment, the developers could:

- (1) capture the problematic performance as soon as it happens,

- (2) recreate the situation step by step in the lab environment,
- (3) and modify the software as well as validate the changes before upgrading the new version of software in the test vehicle.

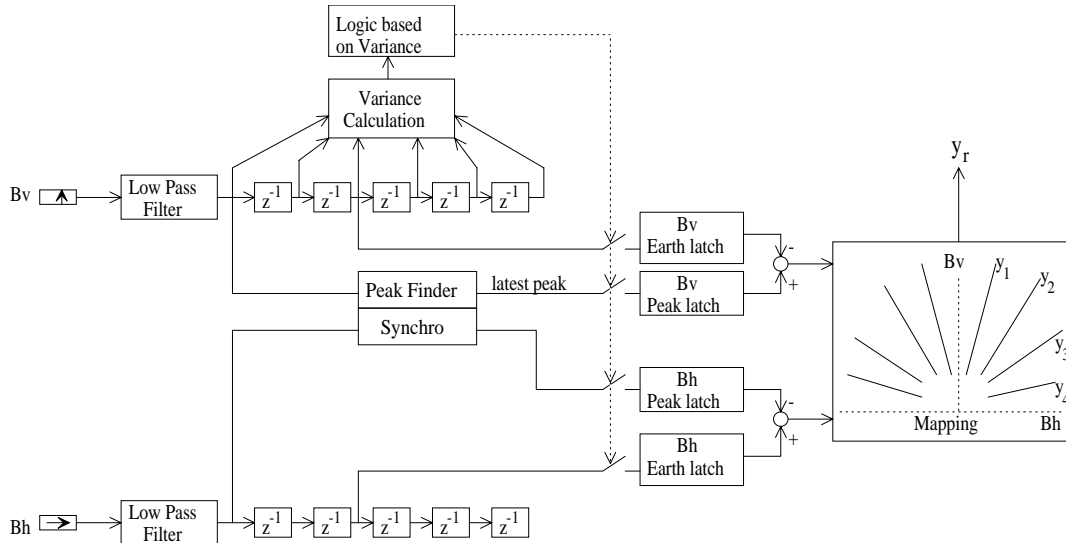

Figure 6-3: “Peak-Mapping” Magnetometer Signal Processing Block Diagram

Link between Magnet Sensing and HMI

This section describes the link from the magnetic sensing signal processing algorithm to the human machine interface display.

Guidance information is crucial for performing the tasks associated with driving. Information that the driver uses is restricted by the recognition and perception for what can be seen and felt. Such information includes forward knowledge for speed control and lateral information for steering control. When the driver does not have a clear view of what is in front of the vehicle, the ability to carry out driving tasks in a safe manner is diminished. From a control-engineering viewpoint, the driver steering function presents itself in the form of a closed-loop control problem. The driver acquires vehicle and road information using his perception; the brain processes these data and directs the hands to steer in order to follow the desired trajectory; various human “sensors” report back the vehicle response with respect to the desired trajectory and thus complete the control loop. Multiple senses are used to support steering functions. By fusing various perception information together, human intelligence derives complex and adaptive control strategies to perform the steering function. However, as soon as the driver switches to using the steering guidance system, application of perception may not occur in the same manner as in the unassisted steering mode. At the same time, the steering guidance system may not be able to supply the same information as perception of the normal driving environment, especially when the vehicle position is obtained through “look-down” lateral sensors [21, 24] such as the magnetic sensing systems. Although with practice the driver is likely to learn to adapt to the new system, it is undesirable if such adaptation requires intensive training, or if the use of such a device demands constant driver concentration.

To alleviate the above problems, a driver display with predictive function was developed. A major component of this lateral assistance display is the prediction feature (see Figure 6-4). This marker shows the future lateral position 20 m ahead corresponding to the magnitude and direction of the steering wheel angle, δ . When the steering wheel is turned left, the prediction marker moves left. The current lateral position of the car, y_0 , is shown at the bottom of the display. The graphics represented a displayed distance of 20 m with a 2 m width between the “curbs.” Road lines are computed using an internal map database of road curvature and heading angle, θ . A driver can steer by positioning the predictor at any desired “future” location. The internal dynamics governed by the prediction control law then steer the vehicle to the predicted position. More detail on the development of this display and sensing system can be found in [19, 21].

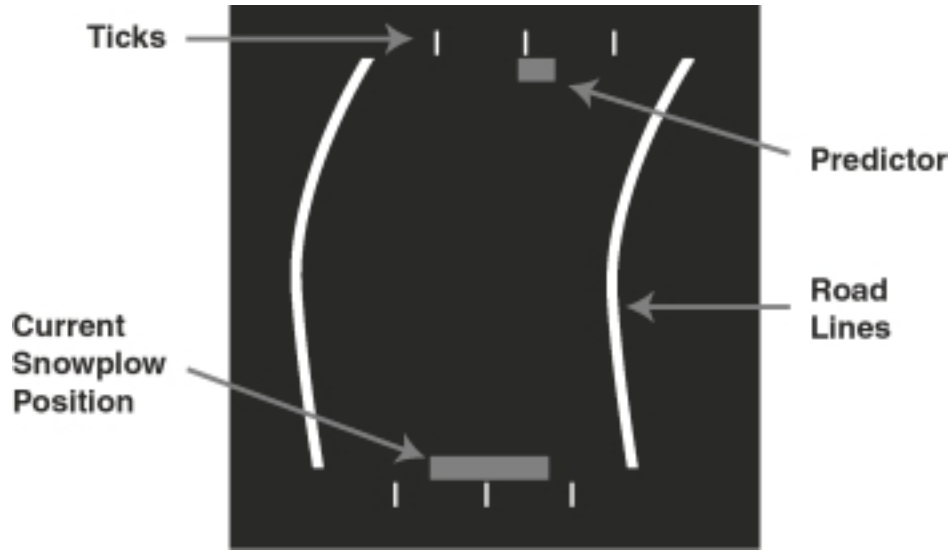

Figure 6-4: The Lane Positioning Assistance Display

The calculation of the lateral position of the prediction marker, y_p , can be described using:

$$y_p = ay_0 + bd\theta + cY(d, \delta) \quad (6-9)$$

where a , b and c are coefficients that describe the gain on each term and d is the look-ahead distance. As a typical example, one can choose the numbers for a , b and c to be equal to one. In such case, y_p becomes the “true” predicted position of the vehicle. The first and second terms in the right hand side of Equation (6-9) represent the components in y_p that are contributed by the current vehicle location, and the vehicle heading angle, respectively. The last term, $Y(d, \delta)$, is the vehicle displacement at d meters ahead of the vehicle if the driver maintains the current steering angle δ . Note that there is no direct sensor providing vehicle heading. Instead, heading angle is output from an estimator, based on the lateral measurement history (moving window), road curvature, steering angle, and a dynamic model of the snowplow. Under normal vehicle operating conditions, Equation (6-9) can be approximated as that in Equation (6-10).

$$y_p = ay_0 + bd\theta + c \frac{d^2}{2} G_v(s) \delta \quad (6-10)$$

where $G_v(s)$ is the dynamic factor between steering angle and vehicle traveling curvature. See [21] for more detailed derivation for the above equations.

ASP-II Lessons Learned for Magnetic Sensing System

- (1) The major problem encountered in the ASP-II magnetic signal processing was the unusually weak magnetic field of multiple magnets around the area of “Big Windy” on I-80. This portion of the road is a concrete base with an asphalt overlay. The magnets were installed at various depths of 1.3-3.8 cm (0.5-1.5 in) below grade. Two different types of sealant were used: Reze Weld 2000 loop-detector sealant, and Reze Weld 1000 concrete epoxy. Although not quantified, visual inspection identified several magnetic markers that were at the surface of the asphalt, i.e. the sealant cap was pulled free, and some magnets showed signs of abrasion or partial damage to the top magnet (each magnet is actually constructed of a stack of four smaller magnets). All of these were sealed with the Reze Weld 2000 loop-detector sealant. No damage was found for magnets installed with Reze Weld 1000. This observation has led to a change in the specification for future installations. By closely examining the test data, the likely source of the problem came from the reduction of the magnetic strength. The observation suggests that a reduction of (30-40%) strength has likely occurred on some parts of the magnets. One of the results of this is more than 50% reduction in variance calculation. However, the identification of the exact locations was not conclusive because such reduction was most visible when the magnet is right between two magnetometers but less apparent when the magnet is just underneath a magnetometer. The signal-processing algorithm was modified to reduce such "low-strength" impact from 33 misses to about four misses. However, such modification does reduce the noise-rejection ability of the software in general and may have other ramifications in the future, such as prohibiting raising up the magnetometers. A better installation method that prevents magnet damage is the fundamental solution.
- (2) The current electrical noise is borderline acceptable. Such electrical noise (sharp, pulse-like) has been identified to be from the switched DC-DC power supply and inverter leaking into the sensor signal from the ground. These noise spikes are currently just within 40 mV (20 mG). Therefore the analog signal must be much larger than this value to maintain a high signal-to-noise ratio (SNR), in order to achieve high lateral position accuracy. To improve the SNR under either magnetic noise or to raise the magnetometer array up, reducing such electrical noise becomes an important issue. Again, the digital data transmission provided by the sensor system being developed at AHMCT will essentially eliminate this issue.
- (3) The current front magnetometer sensor array is installed with the far left magnetometer at one-inch higher position (to the ground) compared to the height of the far right magnetometer. This uneven height in the sensor bar creates increased disparity in the measured signal strength between right and left, which reduces the overall sensitivity of the signal processing algorithm. An evenly installed sensor array is preferred. The height discrepancy in the current system is related to the presence of the wingplow on the right side of the vehicle. The magnetometer array is installed level relative to the vehicle itself; however, due to the weight of the wingplow, the vehicle has a tilt towards the right side. This tilt will vary based on snowplow operating conditions; however, the

recommendation for future vehicle installations is that the sensor bar should be installed parallel to the ground for the average neutral position in order to minimize this effect. If any major repair changes the permanent neutral position of the suspension, the bar should be repositioned so that it is again parallel to the ground. Providing a sensor mounting structure with at least two independent height adjustments may also be of interest.

- (4) The results from ASP-I and ASP-II revealed that the signal processing algorithm shows significant robustness properties under current nominal conditions. However, a software “check” of the magnetometer health is still very beneficial to the operator. A software function that checks for bad magnetometer health signals has been added to the guidance system, and that information is sent to the HMI. In such a case, the message "check sensor" gets printed on the HMI (in lieu of the highway section name) and the display turns to blank. Thus the driver will be notified of sensor failure when it happens.

CHAPTER SEVEN

COLLISION WARNING SYSTEM

Highway snow removal is a hazardous operation. Poor road traction and reduced visibility often lead to collisions with other vehicles and roadside objects. The costs, both human and financial, of such a collision can be substantial. One approach to reducing these costs is to implement a system that provides a virtual buffer zone around the vehicle using visual or auditory warning of an impending collision. Such a system must be able to detect approaching vehicles and determine which pose a threat. Also, the system should be capable of detecting fixed hazards on the road, including stalled cars and highway infrastructure. However, to be useable, such a system must minimize false alerts; otherwise, the system will soon be ignored.

Severe environmental conditions are encountered in mountainous snowplow operations, including blowing snow, spraying salt, and extreme vibrations. Clearly, the collision avoidance system must be capable of surviving and functioning properly in such an environment.

Sensing Requirements

In California, snowplows operate at speeds up to 13.4 m/s (30 mph). Assuming a worst-case tire-to-road friction coefficient of 0.1, corresponding to rubber on glare ice [29], the maximum plow deceleration is 0.1 g. With this deceleration, and assuming a one second delay between any warning provided by the HMI and actual braking action by the operator, the stopping distance versus vehicle speed is shown in Figure 7-1, based on a simple quadratic with constant delay. For the maximum plowing speed, the total distance traveled with this worst-case deceleration is 105 m (344 ft). Ideally, the ranging sensor should provide at least this sensing range. Commercially available sensors typically have a 100 m (328 ft) range, which is deemed adequate. Note that experienced operators will immediately drop the front snowplow blade (nose plow) to increase deceleration in an emergency situation, so that these numbers are conservative.

In addition, to avoid creating false alarms, the sensor should not detect objects that are not potential obstacles. Further, because plowing operations often take place in mixed traffic, a warning that reports only on distance to the nearest object is inadequate. Such a system is incapable of discriminating between an approaching car, a stalled car or other object and a car moving in the same direction as the plow with similar speed, all of which could be the same distance away and pose quite different risks. Thus, closing rate information is needed in addition to range. To reduce false alarms from highway infrastructure and to provide enhanced collision warning when cornering, a radar unit that provides data on the lateral position (azimuth angle) of objects as well as their range and closing rate is also desirable.

Sensing Technologies

Several basic sensing technologies have been developed. These include radar, vision, and acoustic systems. Vision systems, either employing lasers or advanced image processing are very sensitive to weather and considered unsuitable for a snowy environment. No acoustic system evaluated was capable of both providing the needed rate information about approaching objects and operating in the highly vibratory environment of a heavy vehicle. Only radar systems were

found to be sufficiently advanced in development and robust enough for this application. Research during the initial phase of the program, ASP-I, indicated that millimeter-wave radar was indeed sufficient for the task at hand. The radar utilized operates at 24.725 GHz, corresponding to a wavelength of about 1.2 cm, and can resolve targets that are approximately 1 m² or larger.

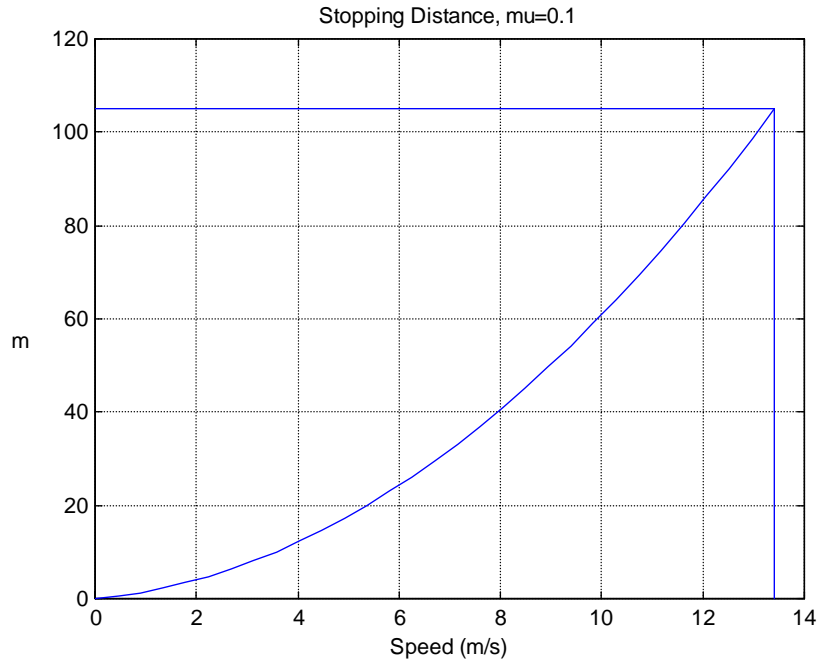

Figure 7-1: Plow Stopping Distance for 0.1 g Deceleration and 1.0 Second Reaction Time

Research and Findings from ASP-I

The initial implementation of the ASP CWS was primarily limited by the sensing capabilities of the Eaton Vorad EVT-200. Because the EVT-200 only provided longitudinal range and rate to the target, and no lateral information, sorting and displaying the targets became complicated. The end result of the CWS was to display up to three targets on the HMI. These targets were displayed by three bars (or “tapes”) whose length represents the target’s distance from the vehicle.

A program was developed which tracks targets, sorts them based on closure rate, then assigns them to a specific bar. Care was made to preserve the target’s bar location, even if another target moves closer to the vehicle, so as not to confuse the operator, as would happen if targets cycled between different bars on the screen.

Operator response to the CWS was mixed [4]. Although the system alerted the operator to the presence of an obstacle, the operator was unable to determine the lateral location of the obstacle and whether it was actually a threat to the ASP.

Research and Findings from ASP-II

Under ASP-II, further development of the CWS focused on assigning obstacles to their actual lane, using a new radar system, the Eaton Vorad EVT-300. This sensor tracks up to seven targets, providing target ID#, closing rate, range, signal quality, and azimuth angle. The addition of the azimuth angle enabled the development of a system which could provide both longitudinal and lateral information of detected obstacles.

Further, it was desired that the CWS could alert the operator to obstacles in front of the vehicle, but in broad lateral displacements from left to right of the vehicle. This was desired to alert the operator of the possibility of “clipping” vehicles to the left or right of the vehicle. The left side is important because other vehicles often pass the snowplow when operating on divided highways, and to detect oncoming traffic in more rural two-lane highways. The right side is important because of the wingplow, which deploys approximately 2.4 m (8 ft) from the right side of the vehicle. Right-side detection was crucial to provide collision warnings for the wingplow. Note that some plows have their wingplow installed on the left side. Thus, the new CWS, herein referred to as the Advanced Collision Warning System (ACWS), provides complete two-dimensional location of obstacles across three lanes of traffic in front of the plow at distances up to 100 m, giving the snowplow operator significantly enhanced situational awareness.

Development of the Advanced CWS

To achieve the goals mentioned above, several factors were considered. The maximum horizontal beamwidth of the EVT-300 is 14° ($\pm 7^{\circ}$). Based on this beam width and a standard 3.6 m (12 ft) lane width, with a single center-mounted antenna, targets in adjacent lanes can be detected at a minimum distance of 14.9 m (48.9 ft) in front of the vehicle and the full width of three lanes, left, center, and right, would be covered at a minimum of 44.7 m (147 ft). Thus, targets in adjacent lanes would disappear from the HMI once they were closer than 14.9 m. This distance was deemed unacceptable and the team set a goal to observe adjacent lanes at less than 10 m (33 ft) in front of the vehicle. Therefore, it was determined that a novel approach employing two radar units would be necessary to achieve the desired performance. Development of a custom single-radar solution would be ideal, but was not feasible within the project scope.

A variety of configurations were evaluated, taking into account physical mouning constraints and the fact that using two radar antennas introduces a center blindspot in addition to the side blindspots (see Figure 7-2). Analysis was done to minimize forward and side blindspots, subject to mounting constraints. The configuration selected was symmetrical, placing the two radar antennas 0.36 m (1.2 ft) from center-line, angled out 4° . This configuration, shown in Figure 7-2, resulted in a forward blindspot of 6.9 m (23 ft), adjacent lane blindspots of 7.4 m (24 ft), and complete three-lane coverage at 26 m (85 ft). It is important to note that the forward blindspot of 6.9 m is a theoretical blindspot based on the intersections of the two radar beams. Thus, it would be the actual forward blindspot if the obstacle were a point. The observed forward blindspot is significantly less than 6.9 m, since obstacles have a finite width. Objects in this blindspot having a width greater than 0.74 m (2.4 ft) are observable down to 0.0 m separation distance, i.e. immediately in front of the sensor, based on geometry considerations.

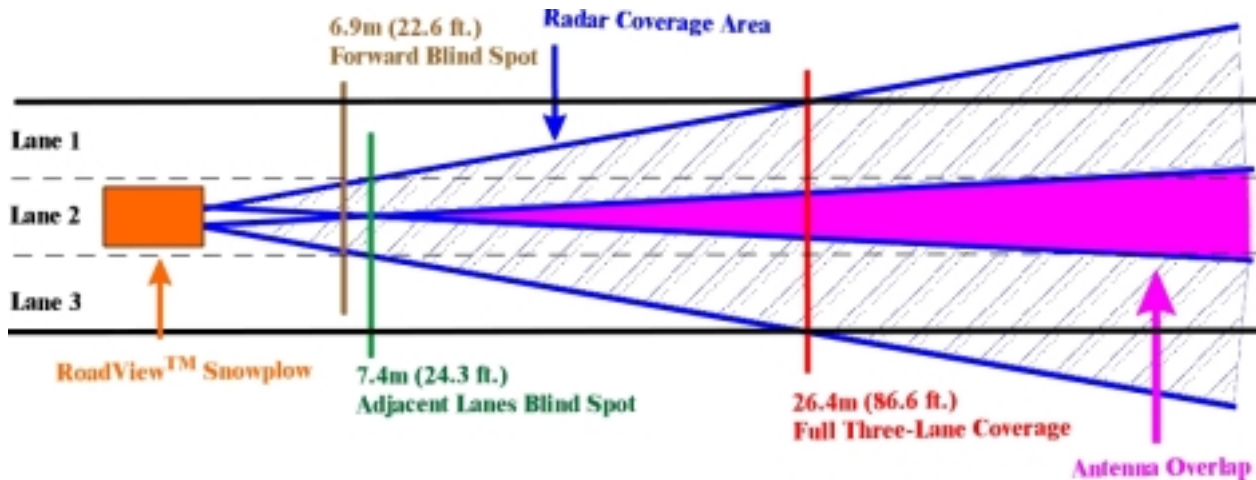

Figure 7-2: Diagram of Area Covered by the Dual EVT-300 CWS.

This configuration also introduced the interesting issue of radar coverage overlap, where a large area is covered by both radars. Since each radar produces up to seven targets, the software must allow for a maximum of fourteen targets. An algorithm was developed which used a series of sorting routines to separate the fourteen targets detected by the two combined sensors into lanes 1, 2, and 3 (left, center, and right, as shown in Figure 7-2). The algorithm then selects the closest target in each lane and displays that target on the corresponding bar on the HMI. In this manner, the three bars on the HMI actually correspond to the left, center, and right lanes. This provides a much more intuitive representation to the operator, again enhancing the quality of situational awareness. The ACWS displays all obstacles detected, including stationary objects with a high closing rate, lead vehicles with a closing rate of zero, and passing vehicles which have a negative closing rate.

This approach of displaying three lanes of forward obstacle detection on an HMI is a novel application of CWS, allowing the operator to observe the driving patterns of vehicles in adjacent lanes even in low- or zero-visibility conditions. The vast majority of CWS research has been done by looking only at the lane directly ahead of the vehicle, generating either an audible warning or automated throttle and/or brake control [2, 6, 30]. A system developed by Veridian Engineering uses multiple radars to detect obstacles left and right of the vehicle, but this application is only for detecting vehicles at intersections [12]. The Minnesota Guidestar vehicle, using the Altra Technologies radar, detects obstacles in the forward and right-hand lane and utilizes an HMI, but only displays obstacles that will impact the vehicle within six seconds and which are within 50 m (163.9 ft) of the vehicle [16].

The ASP-II Advanced CWS (ACWS) has been tested in winter plowing conditions both in California and in Arizona. Operator response to the new system has been positive; see Chapter 5 for detailed operator feedback. Since the operator has an intuitive representation of both the distance to the obstacle and the lane the obstacle is in, the operator is able to confidently respond to any situation. The ACWS configuration will be used in upcoming research entitled “A Rural Field Test of the RoadView™ System,” which will instrument two more plows with RoadView™ technology. The two plows will be tested in several rural locations, including US 299 near

Burney, California, US 180 near Flagstaff, Arizona, and possibly at a new test site in Washington State.

False Warning Suppression Software (FWSS)

To reduce false alarms, algorithms have been developed to prevent a false alarm in a situation like the one shown in Figure 7-3. These algorithms are currently being tested as part of the current research. The use of these algorithms will be evaluated in light of the expectations and needs of the operators. Development and testing in this area will continue in ongoing research.



Figure 7-3: Diagram of Situation Capable of Generating a False Collision Warning

The FWSS is designed to seamlessly integrate with the lane detection algorithms already implemented in ASP-II. The vehicle's turn radius is calculated using vehicle speed, V , provided by the vehicle's data bus, and the vehicle's angular velocity, ω , provided by a rate gyro inside the EVT-300. Note that $\omega > 0$ indicates a left turn, while $\omega < 0$ indicates a right turn. Using this information, assuming $\omega \neq 0$ (straight road), the program calculates a virtual curve origin and the ASP's distance from that origin, R_v (refer to Figure 7-4):

$$R_v = \frac{V}{\omega} \quad (7-1)$$

Each target's Cartesian coordinates are then translated to the new origin:

$$\begin{aligned} y_o &= y_v \\ x_o &= x_v + R_v \end{aligned} \quad (7-2)$$

Next, the Cartesian coordinates are converted to polar coordinates, giving the obstacle's radius and angle from the origin.

$$\theta = \tan^{-1}\left(\frac{y_o}{x_o}\right) \quad (7-3)$$

$$R_t = \sqrt{x_o^2 + y_o^2}$$

Since the ASP's distance from the origin is the center mark of the three desired 3.5 m (12 ft) wide lanes, obstacles detected are assigned to lanes based on that reference point:

$$R_v - \frac{3}{2}d \leq Lane_1 \leq R_v - \frac{1}{2}d$$

$$R_v - \frac{1}{2}d \leq Lane_2 \leq R_v + \frac{1}{2}d \quad (7-4)$$

$$R_v + \frac{1}{2}d \leq Lane_3 \leq R_v + \frac{3}{2}d$$

where $d = 3.5$ m is the nominal lane width. Equation (7-4) is for a left turn—analogue results are simple to envision for a right turn.

Finally, the obstacle's distance to the ASP-II, an arc length, is calculated using the radius and angle from the virtual origin:

$$D_t = R_t\theta \quad (7-5)$$

for a left turn, and

$$D_t = R_t(\pi - \theta) \quad (7-6)$$

for a right turn.

The system's target selection routines are unaffected by the addition of road curvature detection, as the target information is automatically converted to a lane reference frame, with targets identified by distance from the centerline of the ASP-II. Figure 7-4 provides a graphical representation of the road curvature implementation. Extension of this approach to address transitions in future curvature is intuitive, and will be developed under future research. Knowledge of future curvature is provided by the magnet code database. Future curvature can be obtained using a number of other approaches as well. Further discussion of this algorithm can be found in [26]; research and development in this area will continue in a follow-on project.

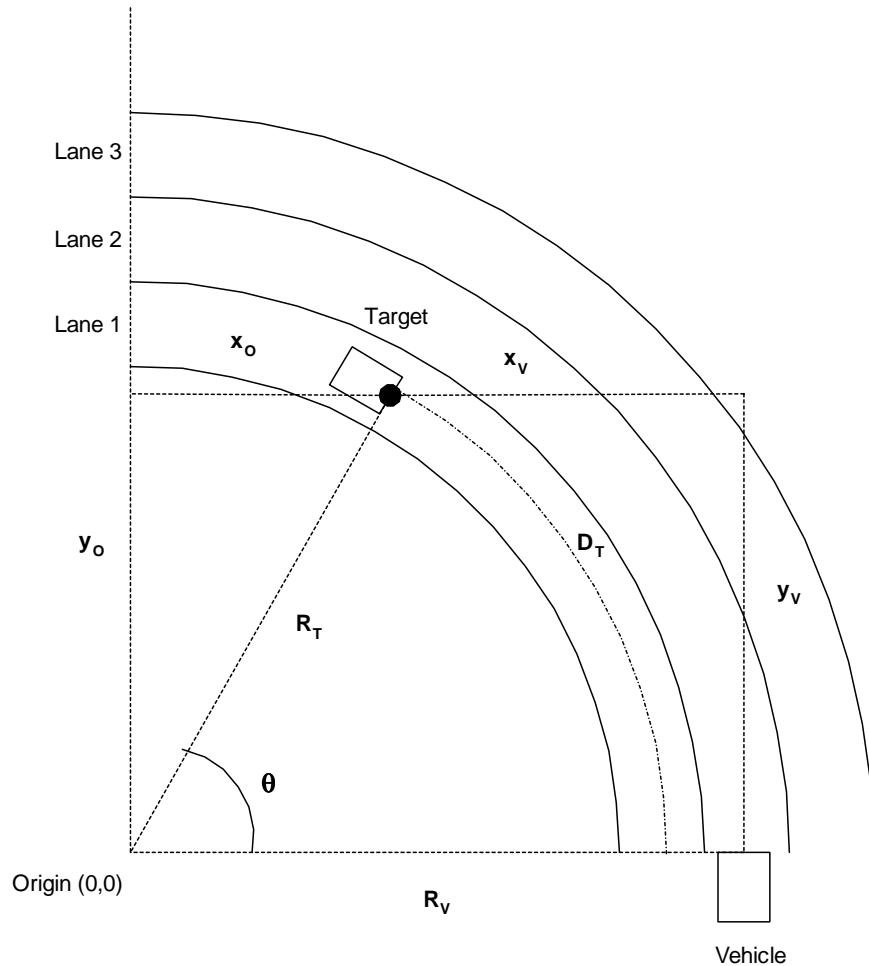

Figure 7-4: Diagram of Road Curvature Coordinate Transformations for False Warning Suppression

Vehicle and Computer Interface

The EVT-300 interfaces to the vehicle in two ways. It connects to the vehicle's SAE J-1587 data bus to extract data on vehicle speed and other parameters. This interface also allows the radar to be tested and configured through the vehicle diagnostic port with the appropriate diagnostic tool, known as a "J-Tool". It also senses brake position through a tap into the vehicle wiring before the brake light, so that it can sense whether the vehicle is braking.

The computer interfaces to the EVT-300 via an RS-232 serial connection, using a converter to connect to the J-1708 (RS-485) bus. Over this connection, several pieces of information are transmitted, including the approach rate of the seven most significant targets, the distance of these seven objects from the plow, their azimuth angle, a quality factor for each target, and target ID information to distinguish between targets. The computer processes the information and displays an appropriate warning for up to three targets on the vehicle display. The processing is described in Chapter 4, while details of the radar display are provided in the HMI description in Chapter 5. The serial interface is documented in reference material from Eaton Vorad.

CHAPTER EIGHT

CONCLUSIONS AND FUTURE RESEARCH

Conclusions

The Phase II Advanced Snowplow (ASP-II) was deployed to the Caltrans maintenance fleet in December, 1999. Caltrans operators used it on a regular basis through the winter of 1999-2000, sometimes continually for several days straight during periods of intense storm activity. Additional testing occurred in our partner state, Arizona, on US 180 near Flagstaff. Research engineers continued to analyze and improve the performance of the system, as well performing minor preventive and responsive maintenance on the system, throughout the season's testing. Data regarding operator use of the system was collected during ride-alongs by the research team. Analysis of this data was presented in Chapter 5; indications are positive.

Qualitatively, the survey results presented in Chapter 5 indicated an increase in the level of comfort with the ASP system relative to Phase I results. Specifically, the fraction of drivers indicating that achieving comfort would take less than three days shifted from about half to about three quarters. With respect to the Collision Warning System, qualitative operator survey response was lower, due in large part to the presence of extraneous warnings on high-curvature rural roads. Reduction of such false warnings is being addressed in follow-on research. Due to the limited number of available data collection runs under the ASP-II study, definitive judgment on the full merits of the system must be deferred for a future study, as discussed below.

It is clear that the ASP-II HMI has the potential to be quite beneficial to driver safety and confidence. Quantitative findings suggest that, even with limited instruction, the interface was intuitive and easy to learn. Most drivers were observed to reach a stable level of performance after driving the ASP-II for one Donner Summit run or less (about four miles). Anecdotal comments and experimenter observations also suggested that the display could easily be used either for reference or as a primary driving mechanism.

Based upon analyses of objective data, the system appears to allow drivers to more consistently maintain a stable position near the lane center. Small drops in performance for speed and steering wheel standard deviation while the system was on do not appear to have substantial functional relevance even though there were statistically significant differences. As such, driving with the system appears to be quantifiably similar, if not slightly better, than unaided driving. In addition, note that the comparisons between "display on" and "display off" were made under less than whiteout conditions. Under whiteout conditions, the display will allow plowing operation to continue in situations where it would not be safe to plow without such a device; this was the primary motivation and goal of the ASP development.

Furthermore, this work suggests that a simple, low-fidelity display reminiscent of early video games can lead to an effective and well-received system. The initial decision to go with a "low-tech" image during ASP-I was based on computational concerns and a desire for simplicity. However, drivers responded well to the display and field measurements showed good performance can be achieved without computationally intensive graphics or custom hardware, a feature that has direct ramifications on commercialization and deployment.

The experience gained during the Phase I study (ASP-I) was invaluable for Phase II efforts. ASP-I, as tested in the Caltrans fleet, is best viewed as a first-generation research prototype. During Phase I, the research team developed a better understanding of the true nature of the harsh operating conditions the system must overcome. In addition, the team gained far better understanding of the entire snow removal operation, based on time spent at the test site; this learning process continued through the current research. The ASP-I experience allowed the research team to develop the second-generation system (ASP-II), advance the robustness of the hardware, enhance and further validate the HMI, and develop quantitative Measures of Effectiveness to allow comparison between the California Advanced Snowplow platforms and similar systems developed in other states.

The results of ASP-II demonstrate the safety and efficiency that can be obtained through judicious application of Intelligent Vehicle technologies for a maintenance vehicle operating in a harsh and hazardous environment. Under whiteout conditions, the system eases the workload of the snowplow operator, while simultaneously enhancing the safety and efficiency of the operation. This concept is applicable across the Special Vehicle category (maintenance, police, fire, and emergency medical), where operators must perform their duties in all conditions in order to ensure public safety and availability of facilities. Appropriate care must be taken in extending results from snowplow-based work into other vehicle types, particularly with respect to intended use and human factors issues. However, in the long term, there are no foreseeable limitations to the application of the ASP concept, i.e. it appears to be applicable across all vehicle platforms, including light vehicles, commercial vehicles, and transit vehicles, under the appropriate operating conditions.

Based on the results for Phase I and Phase II testing, as well as strong interest from several State DOTs, the system concept as embodied in the ASP-II research prototype is a viable launching point for future commercialization. The AHMCT center is investigating methods to transition the system from a research prototype to a state that is ready for a private entity to adopt and provide as a commercial product. In addition to hardware and software revisions, the research team recognizes the need for more detailed testing, data collection, and analysis to support this conclusion; such work is occurring under the follow-on RoadView project. From a technical feasibility standpoint, the concept of driver assistance for snowplow operators has been proven as effective in terms of enhancing safety, and desirable from the operator's point of view. In addition, the technology has been shown to be field-ready through two winter's testing in some of the harshest snow environments in the lower 48 United States. Clearly, ASP-II is a second-generation research prototype, and improvements are needed in terms of manufacturability, further robustness, packaging, cost, etc. However, the research team is committed to continued efforts to enhance the state of the system, and to work with commercial entities to ensure that this valuable addition to the winter maintenance arsenal is transitioned smoothly from a research prototype to a commercially available system.

Future Research and Development

While the system as embodied in the ASP-II prototype vehicle is now ready for transition to detailed commercialization, there are a number of open questions that can be pursued in future research and development.

First, additional field-testing data should be collected to further document the performance, reliability, and user acceptance of the ASP technology. Such a study will significantly enhance the ability of a commercial entity to assess the potential costs and benefits of the system. AHMCT, PATH, and WTI are initiating a project known as “A Rural Field Test of the RoadView™ System.” The intent of this program is to transition ASP technology from research and development, through field-testing, and into initial commercialization of the RoadView technology. The RoadView research will develop two snowplow vehicles equipped with the RoadView driver assistance technology. One of the systems will be tested at a new site to be instrumented on US 299 near Burney, California. The other RoadView-equipped vehicle will be tested along the Interstate 80 test site at Donner Summit, with additional rural testing at Arizona's site on US 180, north of Flagstaff, Arizona. The proposed RoadView field test will be funded by the California State Department of Transportation (Caltrans). This research will include a detailed “needs assessment” study, as well as an extensive cost-benefit analysis of the RoadView technology.

The ASP-II CWS is a great improvement over that in ASP-I. However, there are a number of areas where continued research and development is needed. The CWS system must be made more universal, so that the same system that works well in a six-lane divided interstate will also perform well on a two-lane rural highway. This aspect will receive increased attention as part of the RoadView project, in that multiple plows will be operating in rural two-lane environments, while at least one plow will continue to operate on the multi-lane test site at Donner. It is also desirable to add some form of rear collision warning, as this is a primary mode of snowplow-related accidents; however, actual alarm and alert methods for this approach must be determined. Current work by other researchers in this area focuses on providing warning to the driver of the vehicle behind the plow, using a high-intensity strobe; these efforts hold great promise. Finally, the system will require multiple sensor integration (e.g. inertial, magnets, steering sensing) to reduce false alarm rates, as well as to improve redundancy and fault tolerance. AHMCT researchers are currently developing algorithms and software to address these issues for curved road sections.

As part of the commercialization process, improvements can be made in the in-vehicle sensing systems. Significant steps have been made in this regard by AHMCT, with the development of an Intelligent Sensing Architecture, currently targeted for sensing of discrete magnetic markers, i.e. as a replacement for the existing sensing system in ASP-II. This intelligent system provides numerous advantages over the existing technology. All data transmission is digital, so that electronic noise is eliminated and cabling requirements are vastly reduced. The resulting system is more robust and maintainable, while simultaneously being an order of magnitude cheaper. Sensing algorithm modifications can be made so that the system can provide key information over a wide range of speed, all the way down to zero velocity, thus facilitating use in other operations, such as low-speed bus docking. The signal processing algorithm can be extended to support both discrete and continuous magnetic reference marker systems. In addition, the processing unit can be extended to encompass other aspects of the in-vehicle system, ultimately leading to a “black box” that could be easily retrofitted in an existing vehicle, e.g. in the snowplow cab, allowing a commercial entity to develop a feasible after-market kit. Research and development on this sensing system is continuing at AHMCT, and early versions of the system are currently being considered for commercialization.

Other areas of research may include vehicle and environment modeling, and further integration of vehicle tracking and process data into GIS management solutions. Vehicle and environmental modeling can improve the overall driver assistance and control, as well as providing sensing and control solutions for special-case high-danger situations, such as ice-pack induced accidents. In addition, the driver assistance system can log data that is useful for snow and ice management. Integration of this information into a comprehensive GIS database could enhance the DOT's ability to more effectively keep roadways clear. In addition, real-time knowledge of plowing activities could be integrated into the broader traveler information system, which could prove very useful to the traveling public.

The ASP program has applied discrete magnetic marker based lateral sensing and forward collision warning to provide driver assistance, thus keeping the driver in the loop and allowing deployment of these technologies on public roadways in mixed traffic in a safe manner. The technologies employed in ASP clearly evolved from earlier full vehicle control work, such as that performed under the NAHSC program. Thus, application of these technologies for full automation in appropriate winter maintenance tasks is a reasonable next step. One such project currently in progress is the "Development of the Advanced Rotary Plow (ARP) for Snow Removal Operations," a pooled fund study, led by Caltrans, with participation by the Alaska, Nevada, and Utah DOTs. This project will include full lateral control, along with forward obstacle detection. Application of precision lateral control for the blower will reduce or eliminate contact with the guardrail, while also improving the repeatability and accuracy of the work performed. Collision hazards are introduced by the presence of natural objects, such as large rocks and debris, as well as abandoned vehicles. Obstacle detection technology will provide added safety, as well as reduced DOT liability and repair costs. The combination of automatic vehicle control and obstacle detection is referred to as the Advanced Rotary Plow, or ARP.

Finally, as similar work is occurring in other states, it is critical to continue to develop methods of quantitatively comparing research results in an unbiased manner. As part of ASP-II, California and Minnesota have developed initial cooperative quantitative Measures of Effectiveness (MOEs), which can dictate the needs for future data collection and analysis. As the California project is now ending, and the Minnesota project is just starting, there was unfortunately little overlap in the initial development of these MOEs. However, with continuing work in these areas under the RoadView and other programs, the ASP program will continue to refine MOEs, and continue to work in a cooperative fashion in this development with Minnesota as their project progresses. As the systems being developed have some significant differences with respect to technology and overall approach, it is critical that these MOEs are developed in a way that isolates these differences, and allows for a fair and unbiased comparison of the systems. A draft MOE document is provided in Appendix A. This is considered a living document, and will be revised through future cooperative efforts between the California and Minnesota researchers.

REFERENCES

1. 3M Corporation - Intelligent Transportation Systems - Safety and Security Systems Division, "Lane Awareness System: Preliminary Product Bulletin for Snow Removal Operations,",: 800-328-7098, 2000.
2. H.J. Asher and B.A. Galler, "Collision-Warning in a Mix of Equipped and Unequipped Vehicles," in *Fourth Annual World Congress on Intelligent Transportation Systems*, 1997. Berlin, Germany.
3. Calspan, "Precursor Systems Analyses of Automated Highway Systems: Lateral and Longitudinal Control Analysis," Federal Highway Administration Report No. FHWA-RD-95-122, 1995.
4. E. Cuelho, "An Evaluation of Intelligent Vehicle Technologies on Rural Snowplows," in *Rural Advanced Technology and Transportation Systems International Conference*, 1999. Flagstaff, AZ.
5. K.-T. Feng, H.-S. Tan, and M. Tomizuka, "Future Predictor for Vehicle Steering Guidance - Sensitivity Analysis and Experimental Results," in *38th IEEE Conference on Decision and Control*, 1999. Phoenix, AZ.
6. K. Fujimura, M. Hitotsuya, S. Yamano, and H. Higashida, "76 GHz Automotive Radar for ACC," in *Sixth Annual World Congress on Intelligent Transportation Systems*, 1999. Toronto, Canada.
7. H.A. Ghaida, "A Differential Kinematic Method for Application of GPS in ITS," Ph.D. Dissertation, Department of Mechanical & Aeronautical Engineering, University of California - Davis, 1999.
8. H.A. Ghaida and B. Ravani, "In-Situ Referencing for Differential GPS Corrections in IVHS," AHMCT Report No. UCD-ARR-98-04-02-01, April, 1998.
9. J. Guldner, S. Patwardhan, H.-S. Tan, and W.-B. Zhang, "Coding of Road Information for Automated Highways," *ITS Journal*, **4**(3), p. 187-207, 1999.
10. J. Guldner, H.-S. Tan, and S. Patwardhan, "Analysis of Automatic Steering Control for Highway Vehicle with Look-down Lateral Reference Systems," *Vehicle System Dynamics*, **26**(4), p. 243-269, 1996.
11. G.F. Jacobs, D.M. Hopstock, L.D. Wald, and D.C. Knoll, "Feasibility Demonstration of a Lateral Position Indication System Based on Magnetic Pavement Marking Tape," in *Third Annual World Congress on Intelligent Transportation Systems*, 1996. Orlando, FL.
12. E.H. Jocoy and H.A. Pirson, "Integration of Radar and GPS/GIS for Intersection Threat Detection and Collision Avoidance," in *Sixth Annual World Congress on Intelligent Transportation Systems*, 1999. Toronto, Canada.

13. Y. Kajiya, K. Ishimoto, M. Honda, and K. Kawamura, "ITS Technology R&Ds for Winter Traffic and its Impact," in *Third Annual World Congress on Intelligent Transportation Systems*, 1996. Orlando, FL.
14. R. Mahrt, "Principles of Automatic Guidance of Vehicles on a Lane by Means of Permanent Magnetic Nails and On-Board Computer Control," in *22nd Annual Conference of the IEEE Vehicular Technology Group*, 1971. Washington, DC.
15. D. McGehee, M. Raby, and G. Nourse, "Defining the Operator Interface of a Snowplow Lane Tracking System Based on Field Interviews and Surveys," in *Transportation Research Board Annual Meeting*, 2000. Washington, DC.
16. M. Nookala and S.J. Bahler, "Minnesota Guidestar Intelligent Vehicle Initiative Lateral Guidance and Collision Warning 1998-1999 and 1999-2000 Snowplow Demonstration Projects," in *Sixth Annual World Congress on Intelligent Transportation Systems*, 1999. Toronto, Canada.
17. H. Peng, *et al.*, "Experimental Automatic Lateral Control System for an Automobile," PATH Report No. UCB-ITS-PRR-92-11, 1992.
18. A. Steinfeld and H.-S. Tan, "Preliminary Findings for a Lane-Keeping and Collision-Warning Driver Interface for Snowplow Operations," PATH Working Paper, Report No. UCB-ITS-PWP-99-6, 1999.
19. A. Steinfeld and H.-S. Tan, "Development of a Driver Assist Interface for Snowplows using Iterative Design," (in press) *Transportation Human Factors*, 2000.
20. Y. Takimoto and M. Kotaki, "Automotive Anticollision Radar," *Applied Microwave*, (Fall) 1992.
21. H.-S. Tan and B. Bougler, "A Snowplow Steering Guidance System using Roadway Markers - Problem Formulation and Solution Concept," *Vehicle System Dynamics*, **32**(1), p. 3-22, 1999.
22. H.-S. Tan, B. Bougler, H. Pham, and D. Empey, "Precision Docking Demonstration at Houston," in *Intellimotion*. p. 6-7, 1998.
23. H.-S. Tan, B. Bougler, A. Steinfeld, and P. Kretz, "Snowplow Steering Guidance Display - Design and Validation," in *AVEC 2000, 5th International Symposium on Advanced Vehicle Control*, 2000. Ann Arbor, MI.
24. H.-S. Tan, J. Guldner, S. Patwardhan, C. Chen, and B. Bougler, "Development of an Automated Steering Vehicle Based on Roadway Magnets - A Case Study of Mechatronic System Design," *IEEE/ASME Transactions on Mechatronics*, **4**(3), p. 258-272, 1999.
25. H.-S. Tan and A. Steinfeld, "The Importance of Gain in Driver Assisted Lateral Control," in *ITS America 10th Annual Meeting*, 2000. Boston, MA.

26. C.H. Thorne, T.A. Lasky, and B. Ravani, "Advanced Collision Warning System for the RoadView Snowplow Driver Assistance System," in *Seventh Annual World Congress on Intelligent Transportation Systems*, 2000. Turin, Italy.
27. D. Tufano, "Automotive HUDs: The Overlooked Safety Issues," *Human Factors*, **39**(2), p. 303-311, 1997.
28. T. Wilson, W. Butler, D. McGehee, and T. Dingus, "IVHS Countermeasures for Rear-End Collisions, Driver Warning System Performance Guidelines," in *ITS America Annual Meeting*, 1996. Washington DC.
29. J.Y. Wong, *Theory of Ground Vehicles*. 2nd ed. 1993, New York: Wiley.
30. A.D. Yasunori and Y.T. Butsuen, "Development of Collision Warning System and its Collision Avoidance Effect," in *Fourth Annual World Congress on Intelligent Transportation Systems*, 1997. Berlin, Germany.
31. K.S. Yen, *et al.*, "Advanced Snowplow Development and Demonstration: Phase I: Driver Assistance," AHMCT Report No. UCD-ARR-99-06-30-03, June, 1999.
32. W.-B. Zhang and R.E. Parsons, "Intelligent Roadway Reference System for Vehicle Lateral Guidance and Control," United States Patent Number 5347456, Sept. 13, 1994.
33. W.-B. Zhang, H.-S. Tan, A. Steinfeld, B. Bougler, D. Empey, K. Zhou, and M. Tomizuka, "Implementing Advanced Vehicle Control and Safety Systems (AVCSS) for Highway Maintenance Operations," in *Sixth Annual World Congress on Intelligent Transportation Systems*, 1999. Toronto, Canada.

APPENDIX A

DRAFT COOPERATIVE MEASURES OF EFFECTIVENESS

This Draft Cooperative Measures Of Effectiveness (MOE) document is a living document, and will evolve over time through further cooperative efforts between the California and Minnesota research teams.

Measure of Effectiveness (MOE)

1. Safety

The snowplow guidance system is intended to improve safety and operational efficiency. The snowplow guidance system must not compromise safe operation of the plow, nor should unavailability of the system compromise safety.

Failure or fault in the snowplow guidance system should not induce any instructed unsafe operation of the snowplow. **Failure** in the snowplow guidance system can include intermittent or permanent failures of sensing, processing, information transmission between components, or information/warning displays. System **faults** during the snowplow operation can include those that are induced by failures in the system or components, or environment interference such as weather, roadside, and road surface conditions.

An ***instructed unsafe operation*** for the snowplow guidance system refers to maneuvers that are instructed by the guidance system but are incorrect and/or hazardous. Missing detection of forward obstacles is a special case of fault and deserves special attention.

Safety of the system needs to be verified or validated through safety analysis. At a minimum, a Fault Tree Analysis (FTA) needs to be performed to investigate all possible failures and faults and the consequences.

2. Operator Performance

System effectiveness is related to the ability of the operator to take advantage of the system *features*, some of which can provide help beyond simple guidance. Proper accounting of such elements is necessary, especially for those that have direct impact on other measures.

There are a variety of human factors related metrics that can be valuable as measures of effectiveness. Substantial care should be taken to eliminate biases due to road geometry, weather, and speed, as these all can have significant impacts on system performance. However, it will be important to record how the chosen metrics are affected by such environmental conditions.

Perhaps the simplest measure of operator performance is *Unintended Lane Excursions per Unit Distance*. The main goal of these systems is to keep the snowplow safely within the target lateral range. Thus, it is necessary to measure excursions from this range. Intentional excursions are usually characterized by slow, consistent steering wheel motions; corrections for unintended excursions usually occur quickly after the excursion. Measuring departures from the range can be

filtered by a standard description of steering wheel behavior to discriminate between intentional and unintentional excursions.

The system should be easy to use. Thus, metrics of *mental workload* are valuable. For example, high steering variability implies that the system requires higher levels of mental workload and, therefore, is harder to use. For systems that use strictly visual displays, measuring visual demand is another technique. Using shutter glasses or some analogous method, it is possible to determine the visual attention required to use the system. Lower amounts of visual demand signify an easier to use system with more free visual capacity to check for improved visibility, potential obstacles, and dashboard information.

The system should permit easy and quick *Acquisition of the Target Range* when a plow enters the target area. For example, if a plow departed the instrumented target area for an amount of time beyond a minor excursion and then regained the instrumented area, what was length of the period that the driver spent aligning to the desired path from the point where the plow entered the target range?

3. Availability

The snowplow guidance system will improve the availability of the snowplow for severe operating condition. Therefore, it should work on all roads for which snowplows are designed, including flat or mountainous, as well as straight or winding roads, with asphalt or concrete surface. The effectiveness of the snowplow guidance system will also be measured based on its availability under a variety of weather, road surface, and visibility conditions.

To verify the availability of a snowplow guidance system, analysis and, if necessary, field tests must be conducted to gain knowledge about its availability under relevant operating conditions and environments.

4. Reliability

The reliability of snowplow guidance system is measured by *Mean Time Between Failures (MTBF)*. Failures here refer to both physical breakdown of the system or components and faults due to environmental interference.

Failures and fault should be recorded separately for vehicle and infrastructure elements in order to assess the reliability of the system. For vehicle element damage, care should be taken to describe how non-system induced failures occur. An example would be system hardware damaged by broken vehicle components or impact forces (e.g., from plow blades striking road surface imperfections).

5. Maintainability

The maintainability of snowplow guidance system should be measured by the *frequency* of and *time* required for regular maintenance that is needed in order to support normal operation, and *Mean Time To Restore (MTTR)*.

The maintenance of both vehicle and infrastructure elements should be documented.

6. Cost

The cost of the snowplow guidance system needs to include the following cost elements:

- a. On-vehicle instrumentation, including cost of components and labor for installation.
- b. Roadway instrumentation, including initial cost and replacement cost. This would include roadway infrastructure additions, roadside components, and vehicle-to-roadside communications links.
- c. Maintenance, including cost of labor and parts and time required for lane closures due to maintenance.

7. Potential for extended applications

Shared applications of the infrastructure or vehicle components can improve the cost effectiveness of the system.

APPENDIX B

ASP EVALUATION QUESTIONNAIRE

Advanced Snowplow Evaluation Questionnaire

ASP-II - 1999/2000

We would like to ask you some questions regarding your opinion of the driver assist system. We will not be recording your identity and this information will not associated with you or be used as a means of evaluating your performance. We are only interested in evaluating the system. We may share this with Caltrans/Arizona DOT.

Your participation is voluntary. You are free to refuse to take part. You may refuse to answer any question and may stop taking part in the study at any time. Whether or not you participate in this research will have no bearing on your standing in your job.

How long have you been driving snowplows? _____

How much time have you logged on the Advanced Snowplow? _____

Did you experience this system last winter? Yes No (If "No" skip to Question 2)

For the following questions, please circle the number of your choice:

1) Is the system better than last year?

(Not at all) 1 2 3 4 5 (A lot)

2) How easy is the system to use overall?

(Not easy at all) 1 2 3 4 5 (Very easy)

3) How much do you like the system overall?

(Not at all) 1 2 3 4 5 (A lot)

4) If you had more time to practice with the system, would you like it more?

(No) 1 2 3 4 5 (Yes)

Development of an Advanced Snowplow Driver Assistance System (ASP-II)

5) Please rate the potential of the system to improve your safety:

(Not at all) 1 2 3 4 5 (A lot)

6) Please rate the potential of the system to improve your efficiency:

(Not at all) 1 2 3 4 5 (A lot)

Please answer the questions on the back/next page.

For each *component* (Collision Warning, Lane Keeping):

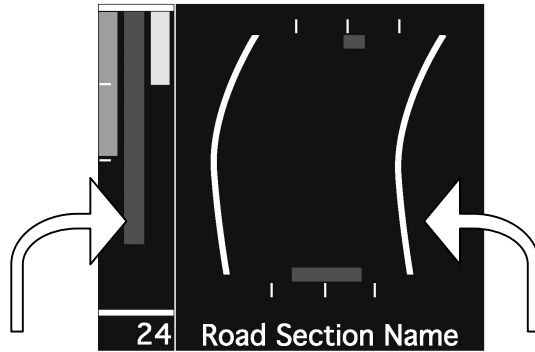

Collision Warning

How easy is this component to use?

(Not easy at all) 1 2 3 4 5 (Very easy)

How much do you like this component?

(Not at all) 1 2 3 4 5 (A lot)

Comments:

Lane Keeping

How easy is this component to use?

(Not easy at all) 1 2 3 4 5 (Very easy)

How much do you like this component?

(Not at all) 1 2 3 4 5 (A lot)

Comments:

How long do you think you would need to become comfortable with this system?

Please draw or describe what you feel would be an ideal display: